

Software RIP

Raster Link 7

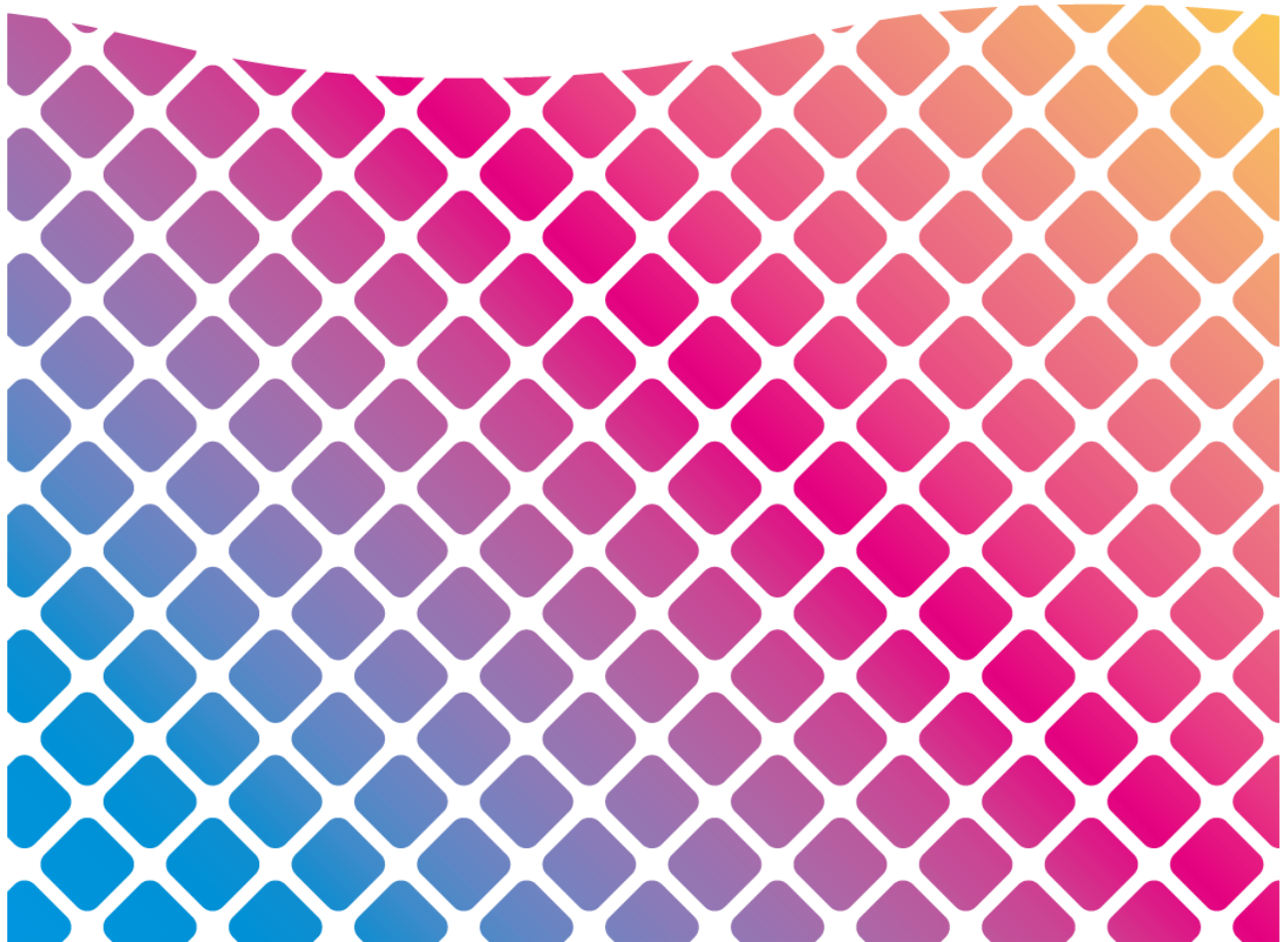

Reference Guide



MIMAKI ENGINEERING CO., LTD.

<https://mimaki.com/>

D203522-34

Table of Contents

Precautions.....	6
About This Guide	7
Notation used in this guide	7
Symbols used in this guide	7
How to obtain this guide and related documents.....	7
Terminology	7
Software Configuration	8
Manuals Related to RasterLink7.....	9

Chapter 1 Basic Operations

1.1 Starting RasterLink7	12
1.1.1 Starting from the Desktop Shortcut.....	12
1.1.2 Starting from the Start Menu.....	12
1.2 Importing Print Data.....	13
1.2.1 Importing from the File Menu.....	13
1.2.2 Importing from the Hot Folder.....	14
1.2.3 Sending from the Printer Driver	15
1.2.4 Dragging and Dropping to the Job List	15
1.2.5 Maximum Number of Jobs That Can be Registered.....	16
1.3 Job Operations	17
1.3.1 Job Operations - Functions.....	17
1.3.2 Job Operations - Screen Layout	17
1.3.3 Job Operations - Operations.....	22
1.4 Log Display	24
1.4.1 Log Display - Functions	24
1.4.2 Log Display - Screen Layout.....	24
1.4.3 Log Display - Operations	25
1.5 Exiting RasterLink7.....	26

Chapter 2 Menus

2.1 File (Open/Restore/Exit)	28
------------------------------------	----

2.2 Function	29
2.2.1 Function Icon List.....	30
2.2.2 Properties	32
2.2.3 PrintGroup	42
2.2.4 Arrange	49
2.2.5 Print Condition	56
2.2.6 Crop	75
2.2.7 General Print.....	78
2.2.8 Tiling	107
2.2.9 Step & Repeat	120
2.2.10 Execute	127
2.2.11 Special plate	134
2.2.12 Composite.....	140
2.2.13 Layer.....	153
2.2.14 Color Replacement	159
2.2.15 Favorite.....	176
2.2.16 Duplicate.....	183
2.2.17 Backup.....	185
2.2.18 Delete	188
2.2.19 Jig Print.....	190
2.2.20 Rigid Media Placement Printing.....	205
2.3 Tool.....	210
2.3.1 RGB Color chart	210
2.3.2 CMYK Color chart.....	210
2.3.3 Special Color chart	219
2.3.4 Lab Color Chart	225
2.3.5 Color Collection	226
2.3.6 Calibration.....	234
2.3.7 Profile Manager	234
2.3.8 Mimaki Remote Access	234
2.4 Environments.....	235
2.4.1 Auto Execution.....	235
2.4.2 [Option]	240
2.4.3 Printer Management	253
2.4.4 Update notify settings...	257
2.4.5 Setup Work Folder.....	261
2.5 About	263
2.5.1 Version.....	263

Chapter 3 Advanced Operations

3.1 Overview of Advanced Operations	266
3.2 Operation Details	267
3.2.1 Print & Cut	267
3.2.2 Twin Roll Printing.....	277
3.2.3 Multilayer Printing	284
3.2.4 Braille Printing.....	286

Chapter 4 Useful Functions

4.1 Job Name Search	288
4.1.1 Display Job Name Search Function	288
4.1.2 Search for a Job	289
4.1.3 Search Using a Barcode Reader	290
4.2 FAQ Page Link	292
4.2.1 Show the Printer FAQ Page	292
4.3 Environment Backup/Restore	294

Chapter 5 Troubleshooting

5.1 Dealing with Error Messages	298
5.2 PC-Related Installation Issues.....	306
5.2.1 Unable to connect to the Internet when using tools.....	306
5.2.2 The screen display is faulty in RasterLink7.	306
5.2.3 RasterLink7 fails to start.	306
5.3 Precautions Regarding Design Software.....	307
5.3.1 Adobe Illustrator Related Issues.....	307
5.4 Macintosh Related Issues.....	320
5.4.1 Precautions when using hot folders.....	320
5.4.2 Ways to improve import speed when printing from design software	320
5.5 Miscellaneous	321
5.5.1 Ways to improve ripping speed for images containing gradation objects	321
5.5.2 How to improve streaking when printing with a printer equipped with clear or primer ink.....	322
5.5.3 Composite is possible but cannot be printed	322

Chapter 6 Appendix

6.1 Available Printing Conditions, by Model	324
6.2 Available Conditions by Cutting Device	327
6.3 Quick Reference Table of Conditions Preventing Function Icon Selection	328
6.4 Special Conditions	334
6.5 About Type of Device Profile	335
6.5.1 Generic Profile	335
6.5.2 Version of Device Profile	335
6.5.3 About Media Name Types of v3 Profile	336

Precautions

- Any unauthorized use or reproduction, in part or whole, of this manual is strictly prohibited.
- The information in this manual may be subject to change without notice in the future.
- Note that some of the descriptions in this manual may differ from the actual specifications due to improvements and revisions to this software.
- Copying Mimaki Engineering Co. Ltd. software described in this manual to other disks (except for the purpose of backup) or loading it to memory other than for the purpose of running it, is strictly prohibited.
- With the exception of what is provided in the warranty provisions, Mimaki Engineering Co. Ltd. does not assume any liability for any damage (including, but not limited to, the loss of profit, indirect damage, special damage, or other monetary damages) resulting from the use or inability to use this product. The same shall also apply to cases where Mimaki Engineering Co. Ltd. has been advised of the possibility of damage in advance. For example, we shall not be liable for any loss of media (work) caused by use of this product or indirect losses caused by products created using the media.

RasterLink is a trademark or a registered trademark of Mimaki Engineering Co., Ltd. in Japan and other countries.

Adobe, the Adobe logo, Acrobat, Illustrator, Photoshop, and PostScript are the trademarks or registered trademarks of Adobe Inc. in the United States and other countries.

Apple, Macintosh, and macOS are registered trademarks of Apple Inc.

Microsoft, Windows, Windows 10, and Windows 11 are the registered trademarks or trademarks of Microsoft Corporation in the US and other countries.

OptiScout is a trademark or registered trademark of Euro-Systems S.à r.l. in Japan and other countries.

CorelDRAW is a trademark of Corel Corporation.

PANTONE® Colors displayed in the software application or in the user documentation may not match PANTONE-identified standards. Consult current PANTONE Color Publications for accurate color.

PANTONE® and other Pantone trademarks are trademarks or registered trademarks of Pantone LLC in the United States and/or other countries. Pantone LLC, 2022

PANTONE® Color support provided by the PANTONE-Licensed Harlequin RIP.

Pantone is the copyright owner of color data and/or software which are licensed to MIMAKI ENGINEERING CO., LTD. to distribute for use only in combination with RasterLink7.

PANTONE Color Data and/or Software shall not be copied onto another disk or into memory unless as part of the execution of RasterLink7.

Other company names and product names described in this guide are trademarks or registered trademarks of their respective companies.



About This Guide

This document describes the functions of RasterLink7.

Notation used in this guide

- The buttons and items displayed in screens are enclosed in square brackets [], such as [Finish] or [Full Color].

Symbols used in this guide

Details		
	Important	The "Important" symbol represents information which you must know before using RasterLink7.
	Tip	The "Tip" pictogram indicates useful information.
	Reference information	Indicates reference pages with related information. Click on the text to display the corresponding page.

How to obtain this guide and related documents

The latest versions of this guide and related documents are available at the following location:













- Mimaki official website (<https://mimaki.com/download/software.html>)





Terminology

Terms	Explanation
Print data or image data	Data created by design software such as Adobe Illustrator.
Job	The work target created by reading with RasterLink7.
Scan	The direction in which the printer head moves.
Feed	The direction toward the rear of the printer.
Restore	Refers to returning to its original state or repair (restoration, recovery).

Software Configuration

The software suite consists of the following software components.

	<p>RasterLink7</p> <p>Software for importing image data, editing jobs created, and controlling the printer.</p>
	<p>Profile Manager</p> <p>Software for managing device profiles and input profiles used with RasterLink7. (For details refer to the separate "Profile Manager Reference Guide".)</p>
	<p>License Tool</p> <p>License authentication is required in order to use RasterLink7. The License Tool is a tool for license authentication. (For details, refer to the separate "RasterLink7 Installation Guide")</p>
	<p>Update Tool</p> <p>Tool for downloading and applying the latest version of programs. (For details, refer to the separate "RasterLink7 Installation Guide")</p>
	<p>RasterLinkTools</p> <p>Plug-in software for Adobe Illustrator for creating printing and cutting data and special color data. (For more information, refer to the separate "RasterLinkTools Guide".)</p>
	<p>Job Migration Tool</p> <p>Tool for transferring a RasterLink6Plus or RasterLink7 jobs to RasterLink7. (For more information, refer to the separate "Job Migration Tool Guide".)</p>
	<p>Environment Backup</p> <p>Tool for backing up RasterLink7 configuration files to a single file and listing them in other environments. (For more information, refer to  "Environment Backup/Restore"(P. 294).)</p>
	<p>Calibration Tool</p> <p>Tool for calibrating using RasterLink7. (For more information, refer to the separate "Calibration Tool Guide".)</p>
	<p>JobCreator</p> <p>Tool for reading jobs into RasterLink7 using templates. (For more information, refer to the separate "JobCreator Guide".)</p>
	<p>RasterLink Interface</p> <p>Tool allowing jobs to be created and printed from Simple Create without having to directly use RasterLink7.</p>
	<p>OptiScoutSettingTool</p> <p>Tool for linking with Euro-Systems OptiScout (cutting machine control software). (For more information, refer to the separate "OptiScout Linkage Guide".)</p>
	<p>CuttingLink</p> <p>Tool used when cutting using ID cut data in RasterLink7. (For more information, refer to  "Print & Cut"(P. 267) and the separate "ID Cut Guide".)</p>
	<p>JigLink</p> <p>Tool for managing information on jigs installed on the printer using barcodes. (For more information, refer to the separate "Jig Barcode Function Guide".)</p>

	<p>PICT A cloud-based printer status monitoring tool. It allows access via the RasterLink7 screen.  P. 19</p>
	<p>Mimaki Remote Access (MRA) Tool for retrieving printer/cutting device information and for configuring the panel settings remotely. It can be launched from the RasterLink7 screen.  "Mimaki Remote Access"(P. 234)</p>

Manuals Related to RasterLink7

The following RasterLink7 related manuals are available at the official website of MIMAKI ENGINEERING.

- **Manuals posted on the RasterLink7 manual download page**

<https://mimaki.com/product/software/rip/raster-link7/download-manual.html>

Name of Manual	Overview
Reference Guide	This document
Installation Guide	Describes how to install and set up RasterLink7.
Network Connection Guide	Describes how to use the RasterLink7 printer driver and hot folder via network.
Profile Manager Reference Guide	Explains about the "Profile Manager" profile management tool.
RasterLink Tools Guide	Explains about the Adobe Illustrator plug-in that assists the creation of RasterLink data.
Variable Printing Guide	Explains about the variable printing function of RasterLink7.
Jig BarCode Function Guide	Explains about the "JigLink" tool for managing the information of tools used with the printer based on barcode and describes how to use it for switching the information displayed on the panel by using the jig print function of RasterLink7.
Calibration Tool Guide	Describes how to perform color calibration by using RasterLink7.
Job Migration Tool Guide	Explains about the tool for transferring a RasterLink6Plus job to RasterLink7.
ID Cut Guide (Using FineCut)	Describes how to print cut data added with ID cut information created by the "FineCut" plug-in cutting software and explains the cutting method.
OptiScout Linkage Guide	Describes how to link with Euro-Systems OptiScout (cutting machine control software).
JobCreator Guide	Describes how to import jobs from templates using JobCreator in RasterLink7.
RasterLink Interface Installation Guide	Describes how to install RasterLinkInterface.

● **Manuals posted on the manual download pages of respective printer models**

Name of Manual	Overview	Model
White/Clear Ink Print Guide	Describes how to print with UJV100Plus white ink and clear ink.	<ul style="list-style-type: none"> • UJV100Plus
Clear Ink Print Guide	Describes how to set the effects (matte, clear, emboss printing) that can be expressed with the clear ink used by a UV machine.	<ul style="list-style-type: none"> • UJV100 • UCJV300, UCJV330 • JFX200EX, JFX600 • UJF-7151plus/plusII • UJF-MKII/MKIIe
2.5DTextureMaker Guide	Describes how to create data using the technique (2.5D Texture Maker) for achieving bumpiness by laying a number of ink layers and explains the printing method.	<ul style="list-style-type: none"> • JFX200EX, JFX600 • UJF7151plusII • UCJV330
Multilayer Printing Guide	Describes how to realize expressive printing by using the technique (multilayer printing) for printing multiple overlapping images in one printing operation.	<ul style="list-style-type: none"> • UCJV300, UCJV330
ID Cut Guide	Describes how to print data added with ID cut by RasterLink7 and explains the cutting method.	<ul style="list-style-type: none"> • Print & Cut machine
Metallic Color Printing Guide	Describes how to create data for printing with silver ink and explains the setting method.	<ul style="list-style-type: none"> • CJV150, CJV300, CJV300 Plus • UJF-7151plus/plusII
Jig BarCode Function Guide	Explains about the "JigLink" tool for managing the information of tools used with the printer based on barcode and describes how to use it for switching the information displayed on the panel by using the jig print function of RasterLink7.	<ul style="list-style-type: none"> • UJF-7151plusII, UJF-6042MKIIe
Color Glossy Print Guide	Describes how to output glossy prints using only color inks.	<ul style="list-style-type: none"> • UJF-7151plusII
Braille Printing Guide	Describes how to create data for printing braille and explains the printing method in Compliant mode.	<ul style="list-style-type: none"> • JFX200-1213EX, JFX200EX-2513EX • UJF-7151plusII, UJF-MKII/MKIIe
High-speed Braille Print Guide	Describes how to create data for printing braille and explains the printing method in Standard speed mode and High speed mode.	<ul style="list-style-type: none"> • JFX200-1213EX, JFX200EX-2513EX • UJF-7151plusII, UJFMKII/MKIIe
Simple Create UJV300DTF-75 Print Guide	Describes how to output from Simple Create to UJV300DTF-75 by using the print settings template.	<ul style="list-style-type: none"> • UJV300DTF-75

Chapter 1 Basic Operations



This chapter

Describes basic operations for RasterLink7

Starting RasterLink7	12	Job Operations	17
Starting from the Desktop Shortcut.....	12	Job Operations - Functions.....	17
Starting from the Start Menu	12	Job Operations - Screen Layout	17
Importing Print Data	13	Job Operations - Operations.....	22
Importing from the File Menu	13	Log Display.....	24
Importing from the Hot Folder	14	Log Display - Functions	24
Sending from the Printer Driver.....	15	Log Display - Screen Layout.....	24
Dragging and Dropping to the Job List.....	15	Log Display - Operations	25
Maximum Number of Jobs That Can be Registered.....	16	Exiting RasterLink7	26

1.1 Starting RasterLink7

Start RasterLink7 from the desktop shortcut or Start menu.

● User Account for Using RasterLink7

1. RasterLink7 can be used with either a Windows administrator or standard user account. Note, however, that some restrictions apply to the following features when using a standard user account:
 - Printer registration
 - Creating hot folders and printer drivers, and recovering them when damaged
 - Installing RasterLink7 and MimakiDriver
 - Program updating

When using the above features, log in using an administrator account.

2. To switch between administrator and standard user accounts, first either log off or restart. RasterLink7 will not operate correctly if you use "Switch user" within Windows.

1.1.1 Starting from the Desktop Shortcut

- 1 Double-click the [RasterLink7] icon  on the desktop.

- A User Account Control dialog appears.

- 2 Click [Yes].

Important! User Account Control

- If a shield symbol is displayed on the shortcut icon, a User Account Control dialog will appear when you start RasterLink7. Click [Yes].

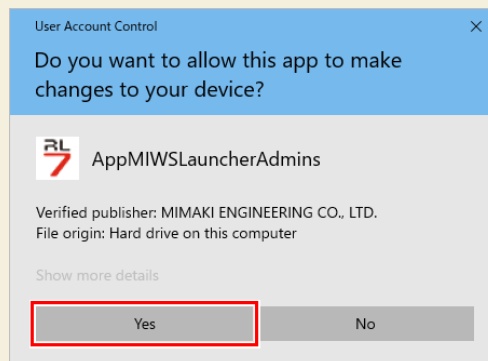

1.1.2 Starting from the Start Menu

Select [Mimaki RasterLink7] - [Mimaki RasterLink7] from the Start menu. Click [Yes] on the User Account Control dialog that appears.

1.2 Importing Print Data

Print data can be imported using any one of the following four methods:

- Importing from the [File] menu
- Importing from the Hot Folder
- Sending from the Printer Driver
- Dragging and Dropping to the Job List

A job will be created from the imported print data.

Important!

- There is a limit set for the total number of jobs that can be managed for all of the printers registered in RasterLink7. The default setting is 200 jobs, and this can be changed to a maximum of 1,000 jobs. For more information, refer to  "["Maximum Number of Jobs That Can be Registered"](#)(P. 16).

1.2.1 Importing from the File Menu

1 Select [File] - [Open].

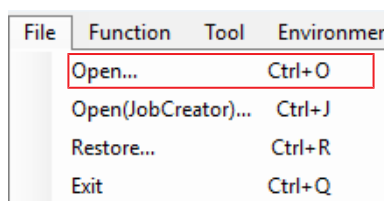

- The dialog can also be displayed by pressing Ctrl + O.

- The [Select file name to print] dialog appears.

2 Select the Print data, then click [OK].

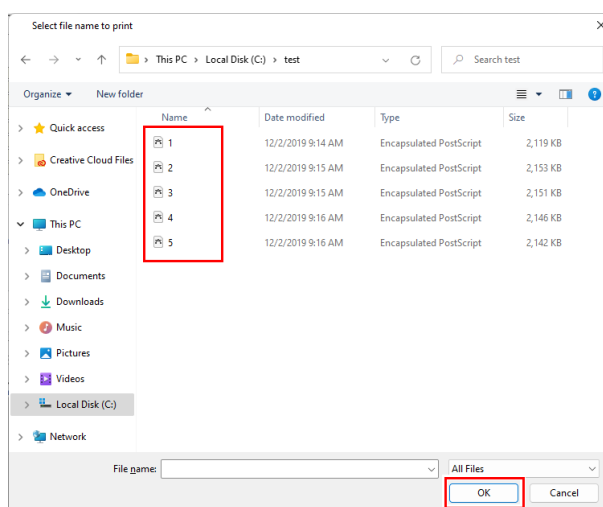

- Multiple print data files can be selected.
Shortcut files to print data cannot be selected.
- Printer and favorite settings selection screen is displayed.

3 Select a printer from [Printer Name].

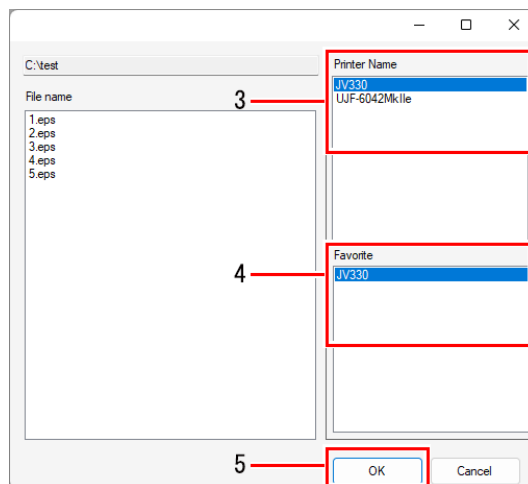

4 Select the favorite settings to be applied in [Favorite].



- RasterLink7 lets you save various settings as favorites. Previously saved settings can also be applied to newly imported print data.
- The favorite settings selected for importing will be selected automatically the next time data is imported.

5 Click [OK].

- Print data will be imported, then a new job will be created.

1.2.2 Importing from the Hot Folder

1 Copy print data to the hot folder.

- A job will be created.
- The favorite settings will automatically be applied to the job created.



- The hot folder will automatically be set as shared when created.
- For details of how to create a hot folder, refer to  P. 182.
- For more information on using hot folders over a network, refer to the separate "RasterLink7 Network Connection Guide".

1.2.3 Sending from the Printer Driver

1 Prints using the software with which the print data was created.

- A job will be created.
- The favorite settings will automatically be applied to the job created.



- The printer driver will automatically be set as shared when created.
- For details of how to create the printer driver, refer to [P. 182](#).
- For more information on using printer drivers over a network, refer to the separate "RasterLink7 Network Connection Guide".



Important! If print data does not appear in the job list after it has been imported from a printer driver, check the following:

- If multiple printers are registered in RasterLink7, the printer to which the print data was imported may differ from the printer currently displayed. Select the [Printer] tab.
- The number of jobs registered in RasterLink7 may have exceeded the maximum number allowed.
["Log Display"\(P. 24\)](#) Check [].
 For more information, refer to ["Maximum Number of Jobs That Can be Registered"\(P. 16\)](#).

1.2.4 Dragging and Dropping to the Job List

1 Drag and drop the print data to the [Job List] tab.

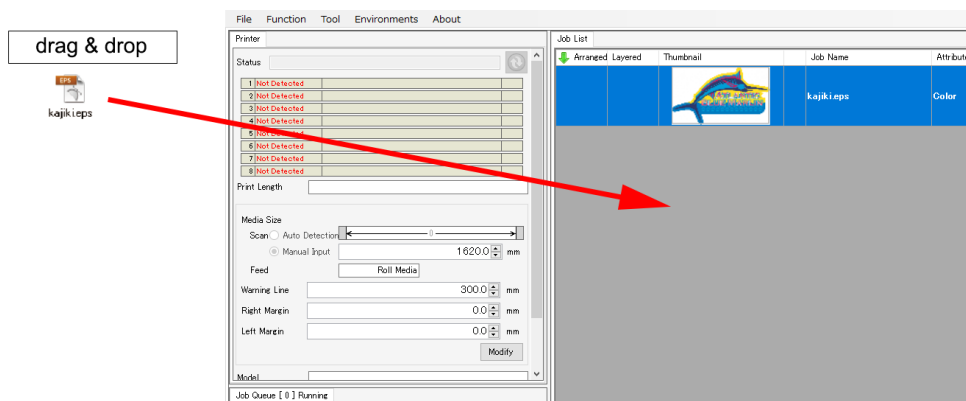

- The [Select file name to print] dialog appears.

2 Select a printer from [Printer Name].

3 Select the favorite settings to be applied in [Favorite].

4 Click [OK].

- Print data will be imported, then a new job will be created.

1.2.5 Maximum Number of Jobs That Can be Registered

The maximum number of jobs that can be registered in the job list will be the value set using [Option] - [Job Control] - [Number of jobs that can be registered] (☞ "[Option] - Operations"(P. 241)). (The initial setting is 200, and this can be set up to a maximum of 1,000 jobs.)

This number is the combined number of jobs for all of the registered printers.

If you attempt to import more upper jobs, the subsequent operation will vary, depending on the method used to import the jobs.

(1) Importing from the [File] menu

(2) Dragging and dropping to the Job List

(3) Importing from the Hot Folder

(4) Sending from the Printer Driver

- In the case of methods (1) and (2):

The following message is displayed. Any additional jobs you attempt to register will be canceled.

Message: "The maximum number [***] of registered jobs has been exceeded. No more jobs can be registered. Please delete unnecessary jobs." For more information, refer to ☞ "Dealing with Error Messages"(P. 298).

- In the case of methods (3) and (4):

The following message is displayed. Any additional jobs you attempt to register will be queued.

Message: "The number of Jobs is above the limit. No more jobs can be registered. Please delete unnecessary jobs. xx Jobs are waiting to be read. "

Once other jobs have been deleted and the total number of registered jobs is less upper, jobs will be added to RasterLink7 in the order in which they were queued. The following confirmation dialog will appear if there are jobs remaining when you exit RasterLink7 or delete a hot folder.

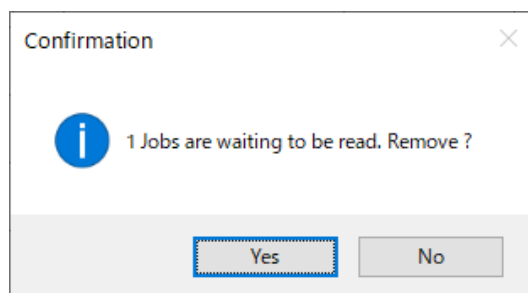

- Jobs that include cutting are counted as two jobs, since they are composite jobs consisting of both a regular job and a job with cutting attributes.

1.3 Job Operations

1.3.1 Job Operations - Functions

RasterLink7 allows you to edit jobs created by importing image data.

1.3.2 Job Operations - Screen Layout

● Explanation of screen

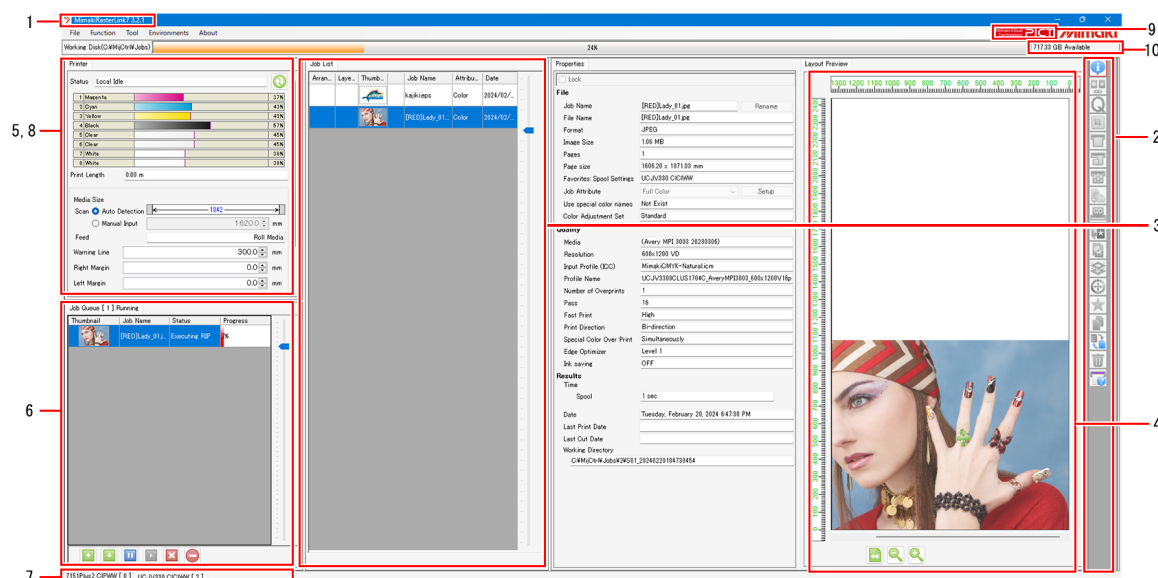

1. Title Bar

The RasterLink7 version and the current user's permissions are displayed.

2. Function icons

Click on an icon to go to the setup screen for the corresponding functions. The icons for functions that are not available are grayed out. A scroll bar is displayed if there are more icons than can fit on the screen.

Important!

- The icons displayed will vary depending on the printer being used.
- The icons that can be selected will vary depending on the individual job.
- The icons can be resized, and unwanted icons can be hidden. For more information, refer to ["Setting a function icon"\(P. 255\)](#).

3. [Job List] tab

Displays the job list. This is displayed when any of the following functions are selected:

[Properties], [Arrange], [Composite], [Special plate], [Execute], [Duplicate], [Backup], [Delete]

4. [Layout Preview]

Displays the layout status for the jobs selected in [Job List].

This can be hidden or shown using the [Display] tab on the [Option] window. [P. 248](#)

5. [Printer] tab

Displays information on the currently connected printer. This is displayed when any of the following functions are selected:

[Properties], [Arrange], [Composite], [Special plate], [Execute], [Duplicate], [Backup], [Delete]



- The details displayed will vary depending on the printer being used.

6. [Job Queue] tab

- Displays the image data importing, RIP, and print status. This is displayed when any of the following functions are selected:

[Properties], [Arrange], [Composite], [Special plate], [Execute], [Duplicate], [Backup], [Delete]



- "Auto executing" is displayed on the [Job Queue] tab when auto execution starts P. 239.

- The process order can be altered, and jobs can be paused, restarted, or stopped. For more information, refer to "[Job Queue] tab"(P. 129).

7. [Printer Select] tab

Selects the corresponding screen for each printer registered in [Printer Management]. The total number of jobs created for that printer appears next to the printer name.

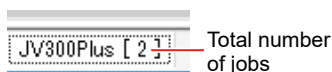

8. [Print progress] tab

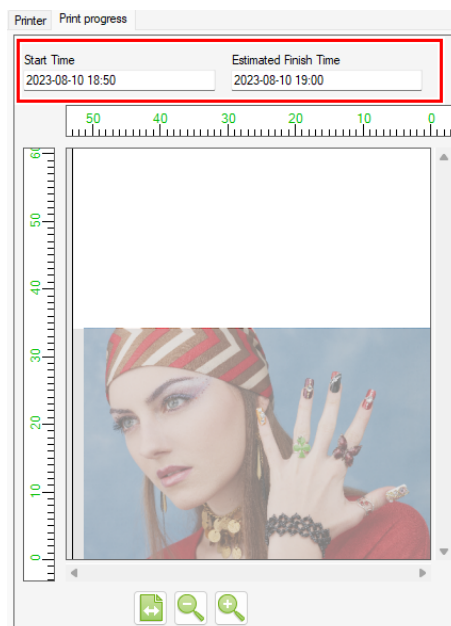

Opening this tab while printing a job on a supported device displays the print start time and scheduled print end time.

- This window is displayed when the [Environments] - [Option] - [Display] - [Display print progress] check box is selected. "Set the display"(P. 248)
- Supported devices
JV300, JV150, CJV300, CJV150, UCJV300, JV300 Plus, CJV300 Plus, JV100, TS100, JV330, CJV330, TS330, UCJV330, TxF150, TxF300, CJV200, JV200, TS330-DS, Tx330, Tx330-Hybrid, UJV300DTF, UJV100, UJV100Plus, TS200, UJV200, UJ330H



- The print progress does not appear when Print & Cut jobs or pull back printing is set.

9. [PICT] button

Access the PICT cloud-based printer status monitoring tool.

For more information about PICT, see the following website.

<https://mimaki.com/product/software/remote/pict/>

10. Working disk usage

Displays the amount of disk usage on the drive where the working folder is stored.

This can be hidden or shown using the [Display] tab on the [Option] window. P. 248

● [Job List] window

• Explanation of columns

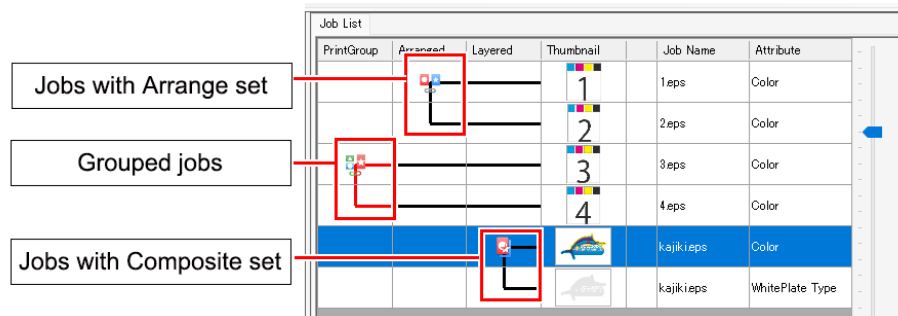

Column	Overview	Sort ^{*1}
[PrintGroup]	Grouped jobs are linked by lines "PrintGroup"(P. 42).	
[Arrange]	Arranged jobs are linked by lines "Arrange - Functions"(P. 49).	✓ ^{*2}
[Composite]	Composite jobs are linked by lines "Composite"(P. 140).	
[Thumbnail]	Displays the job thumbnails.	
(Lock icon)	This icon is displayed to indicate that the job is locked. "Properties"(P. 32)	
[Job Name]	Displays the job names. This can be changed in Job Properties "Properties - Functions"(P. 32).	✓
[Attribute]	Displays the job attributes. The attributes will vary depending on the settings. <ul style="list-style-type: none"> • Color: Job created from regular images. • Cut: Job created from images including cut data. • (Ink color) Plate Type: Job with single color replacement ("Print a full-color job in monotone"(P. 35)) specified or job created using special plates ("Special plate"(P. 134)). Other attributes are explained for the respective settings.	
[Copy]	Displays the copies set on the General Print screen.	
[Rotation]	Displays the rotation settings set on the General Print screen.	
[Mirror]	Displays the results of the mirror settings set on the General Print screen and the Composite screen.	
Date	Displays the date and time on which the job was registered.	✓

Column	Overview	Sort ^{*1}
Last print date	Displays the date and time when the last printing was performed.	✓
Last cut date	Displays the date and time when the last cutting was performed.	✓





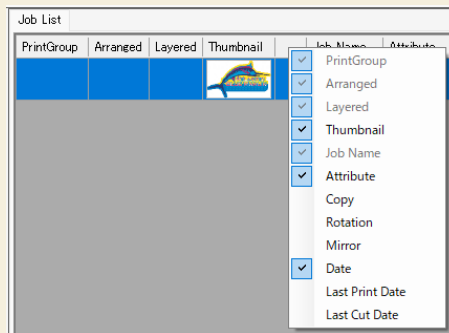

- *1. Clicking the corresponding title row sorts by grouped (layered/arranged) job. Grouped jobs are sorted based on the information for the top job.
- *2. Sorts by job name. (Has the same effect as clicking on the job name.)



- Ripped data appears in bold font.
- The slider on the [Job List] tab can be moved up and down to adjust the list spacing.
- Right-click a column of the [Job List] to display a pop-up menu, allowing you to display or hide individual columns. Columns are displayed if they are checked on the menu.







• **Explanation of job background colors**

Color	Status
 (white)	Queued
 (green)	Executed <ul style="list-style-type: none"> • When printing only for Print & Cut jobs, the color changes for the print job only. • When cutting only for Print & Cut jobs, the color changes for the cut job only.
 (cream)	Printed, but no ripped data exists <ul style="list-style-type: none"> • [Immediate Print] has been executed and completed • [RIP and Print] or [Print Only] has been executed and completed with the [Delete ripped data after print] checkbox checked
 (pink)	Aborted
 (magenta)	Error
 (blue)	Currently being executed

- **Explanation of pop-up (right-click) menu**

Select a job and right-click to display a pop-up menu.

Immediate Print	Ctrl+1
RIP and Print	Ctrl+2
RIP Only	Ctrl+3
Print Only	Ctrl+4
Cut <-> RIP and Print	Ctrl+5
Cut <-> Print	Ctrl+6
Top	Ctrl+T
Bottom	Ctrl+B
Duplicate	Ctrl+D
Delete Ripped Data	Ctrl+Back
Delete All Data	Ctrl+Del
Recreate(JobCreator)...	Ctrl+Shift+J

[Immediate Print] [RIP and Print] [RIP Only] [Print Only] [Cut <-> RIP and Print] [Print <-> Cut] [Cut Only]	Executes the selected job  "Execute"(P. 127).
[Top]	Moves the selected job to the top of the [Job List].
[Bottom]	Moves the selected job to the bottom of the [Job List].
[Duplicate]	Duplicates the selected job  "Duplicate"(P. 183).
[Delete Ripped Data]	Deletes the ripped data for the selected job  "Delete"(P. 188).
[Delete All Data]	Deletes the selected job  "Delete"(P. 188).
[Recreate(JobCreator)...]	Imports the selected job into the JobCreator template and uses the template to re-create the job. For more information on JobCreator, refer to the separate "JobCreator Guide".





- When double-click the job of [Job List], moves to the General Print screen  "General Print - Screen Layout"(P. 79).

1.3.3 Job Operations - Operations

The procedure for printing a single image is as follows.





1 Click a job in [Job List].

- The job is selected.

Arranged	Layered	Thumbnail	Job Name	Attribute
<input checked="" type="checkbox"/>	<input type="checkbox"/>		Nadeshiko_v_eps	Color
<input type="checkbox"/>	<input type="checkbox"/>		Heart_v_eps	Color
<input type="checkbox"/>	<input type="checkbox"/>		Butterfly_v_eps	Color



- To select multiple consecutive jobs, select the first job, then select another job while depressing the [Shift] key.
- To select multiple jobs, select jobs while depressing the [Ctrl] key.

Arranged	Layered	Thumbnail	Job Name	Attribute
<input checked="" type="checkbox"/>	<input type="checkbox"/>		Nadeshiko_v_eps	Color
<input checked="" type="checkbox"/>	<input type="checkbox"/>		Heart_v_eps	Color
<input checked="" type="checkbox"/>	<input type="checkbox"/>		Butterfly_v_eps	Color
<input checked="" type="checkbox"/>	<input type="checkbox"/>		Flower_v_eps	Color
<input checked="" type="checkbox"/>	<input type="checkbox"/>		Kimono_v_eps	Color

2 Select the required function from the [Function] menu or the corresponding function icon.

- This switches to the corresponding function screens  "Explanation of screen"(P. 17).

3 Configure the various settings for the jobs.

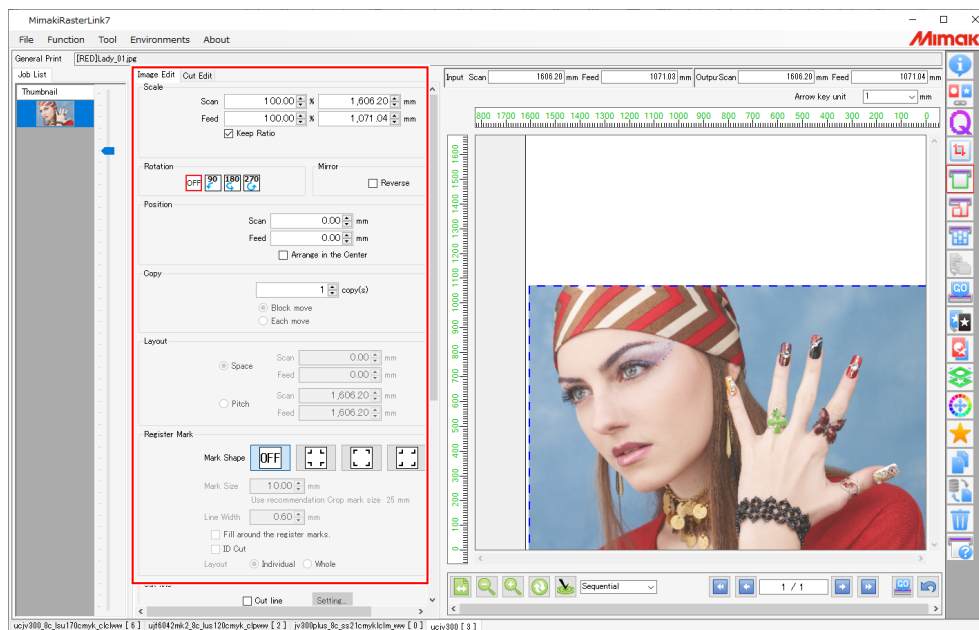

4 Click [Execute] at the bottom right of the window.

- This switches to the [Execute] screen (☞ "Execute - Screen Layout"(P. 128) and executes the job(s) automatically.

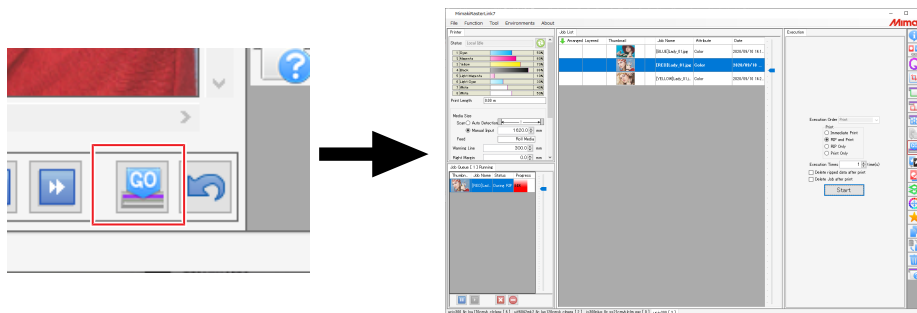

- The method used for execution when [Execute] is clicked can be set in [Option] - [Job Control]. For more information, refer to Job execution settings (☞ P. 247).

1.4 Log Display

Displays the job progress status.

1.4.1 Log Display - Functions

Log information, including job processing status, errors, and warnings, is displayed on the RasterLink7 [Log Display] screen.

If the [Log Display] screen is closed, it is displayed by the Windows notification function.

Important! Windows notification function:

- Closing the RasterLink7 [Log Display] screen reverts to the Windows notification function display, but information will not be displayed if the notification function is turned off. The notification function should be turned on if you require the information to be displayed.
- The Windows notification function displays only errors and warnings. Job processing status information is not displayed.

1.4.2 Log Display - Screen Layout

● [Log Display] screen

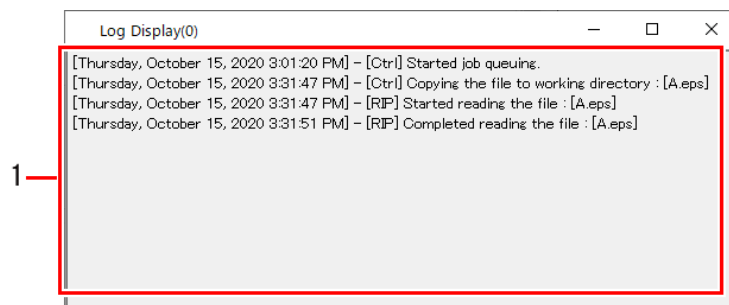

1	Message display area	Displays messages.
---	----------------------	--------------------



- Messages are displayed in different colors according to their type.
 Red: Error
 Blue: Warning
 Black: Regular

● Error and warning display screen

When errors and warnings occur in RasterLink7, these are displayed as pop-up messages in the PC task tray (bottom right of the PC screen).

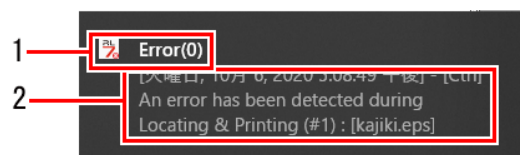

1	Message type	Indicated as [Warning] or [Error].
2	Message display area	Displays errors and warnings.

1.4.3 Log Display - Operations

● Display [Log Display] screen

1 Open the task tray at the bottom right of the Windows screen.

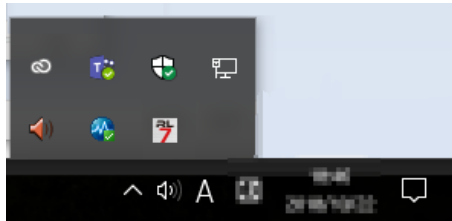

- The icons are displayed for the resident programs in the task tray.

2 Click the RasterLink7 icon.

- Or right-click, then click [Open Log Display].

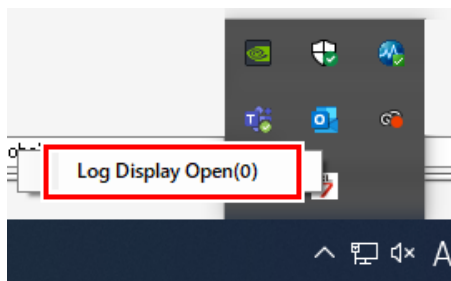

- The [Log Display] screen is displayed, displaying the message details.

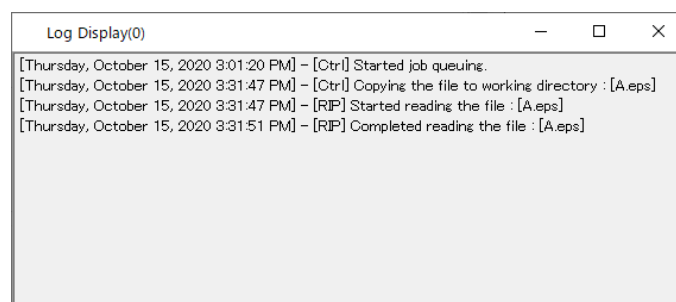

- Closing the [Log Display] screen reverts to the Windows notification function.

1.5 Exiting RasterLink7

The procedure for exiting RasterLink7 is as follows:

- Select [File] - [Exit].
- Click the x at the top right of the window.
- Keyboard shortcut: Press the [Q] key while holding down the [Ctrl] key.

Important!

- The various job settings are saved automatically when exiting RasterLink7.
- The last used state will be restored when RasterLink7 is next started.

Chapter 2 Menus



This chapter

Explains the RasterLink7 menu items.

File (Open/Restore/Exit).....	28	Jig Print.....	190
Function.....	29	Rigid Media Placement Printing.....	205
Function Icon List.....	30	Tool.....	210
Properties.....	32	RGB Color chart.....	210
PrintGroup.....	42	CMYK Color chart.....	210
Arrange.....	49	Special Color chart.....	219
Print Condition.....	56	Lab Color Chart.....	225
Crop.....	75	Color Collection.....	226
General Print.....	78	Calibration.....	234
Tiling.....	107	Profile Manager.....	234
Step & Repeat.....	120	Mimaki Remote Access.....	234
Execute.....	127	Environments.....	235
Special plate.....	134	Auto Execution.....	235
Composite.....	140	[Option].....	240
Layer.....	153	Printer Management.....	253
Color Replacement.....	159	Update notify settings... ..	257
Favorite.....	176	Setup Work Folder.....	261
Duplicate.....	183	About.....	263
Backup.....	185	Version.....	263
Delete.....	188		

2.1 File (Open/Restore/Exit)

The [File] menu at the top of the main screen allows the following operations.

File	Function	Tool	Environment
	Open...		Ctrl+O
	Open(JobCreator)...		Ctrl+J
	Restore...		Ctrl+R
	Exit		Ctrl+Q

● Open...

Selects and imports print data. For more information, refer to  ["Importing Print Data"\(P. 13\)](#).

● Open (JobCreator)

Imports print data using the template with JobCreator. For more information, refer to the separate "JobCreator Guide".

● Restore

Imports a job backup file as a current job. For more information, refer to  ["Backup"\(P. 185\)](#).

● Exit

Exits RasterLink7.







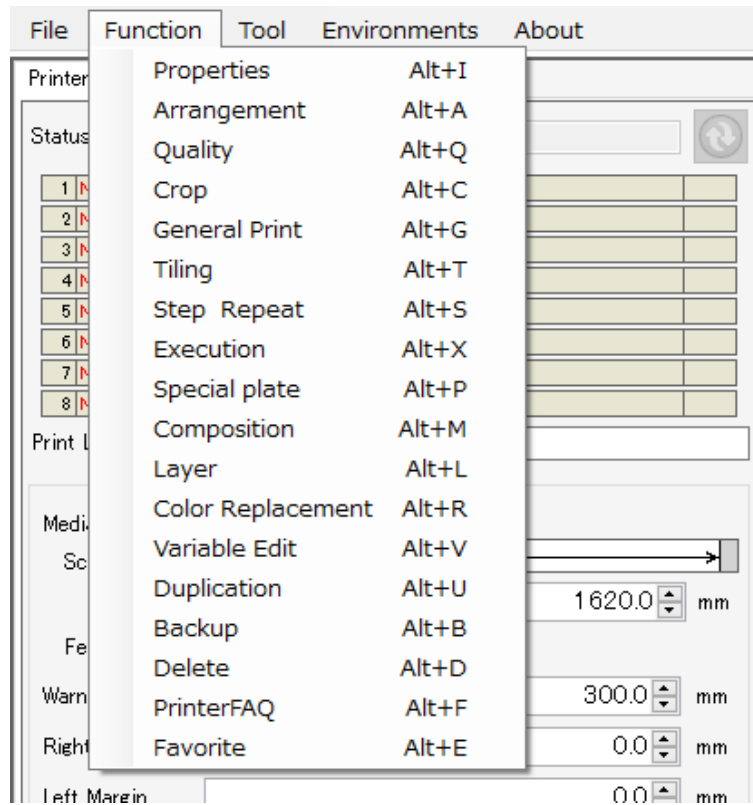



















2.2 Function













The [Function] menu displays the function icons  "Function Icon List"(P. 30) as a menu.

- The [Function] menu can be hidden using the [Function icon setting]. For more information, refer to  "Setting a function icon"(P. 255).
- The [Function] menu also displays those functions set to be hidden in Step 6 of [Function icon setting].



2.2.1 Function Icon List

Icon	Function	Explanation	Shortcut key	Details
	Properties	Displays the job and printer information and allows the job attributes to be edited.	Alt+I	 P. 32
	PrintGroup	Combines multiple jobs into a single job. Grouped jobs can be ripped in parallel.	Alt+W	 P. 42
	Arrange	Combines multiple jobs into a single job.	Alt+A	 P. 49
	Print Condition	Sets the print conditions.	Alt+Q	 P. 56
	Crop	Crops part of a job.	Alt+C	 P. 75
	General Print	Sets basic parameters such as job size, position, and number of copies before printing.	Alt+G	 P. 78
	Tiling	Divides large jobs before printing. This function is unavailable with the default settings when using a flatbed printer. ^{*1}	Alt+T	 P. 107
	Step & Repeat	Lays out image data with no gaps between them before printing. This function is unavailable with the default settings when using a flatbed printer. ^{*1}	Alt+S	 P. 120
	Variable Edit	It extracts information from the database and prints out jobs with different contents one by one. For details see the separate "RasterLink7 Variable Print Guide".	Alt+V	-
	Execute	Prints and cuts the selected job. Also estimates the amount of ink used for printing.	Alt+X	 P. 127
	Special plate	Creates a job specifically for a special color ink from the selected job. This function is displayed for printers equipped with special color ink.	Alt+P	 P. 134
	Composite	Combines multiple jobs on top of each other.	Alt+M	 P. 140
	Layer	Configures the detailed settings for jobs printed with overlaid color and special color ink. This function is displayed for printers equipped with special color ink.	Alt+L	 P. 153
	Color Replacement	Replaces the job colors with different colors.	Alt+R	 P. 159

Icon	Function	Explanation	Shortcut key	Details
	Favorite	Saves and manages the various function settings as a favorite.	Alt+E	 P. 176
	Duplicate	Duplicates the selected job.	Alt+U	 P. 183
	Backup	Creates a job backup file. Restores a backed-up job from a file.	Alt+B	 P. 185
	Delete	Deletes a job.	Alt+D	 P. 188
	Printer FAQ	Opens the printer support page on the Mimaki website.	Alt+F	 P. 292
	Jig Print	Positions the job on a jig before printing. This function is displayed for flatbed printers.	Alt+J	 P. 190
	Kebab jig printing	Prints using a Kebab system. This is displayed when a Kebab system is fitted to the printer. For more information on Kebab jig printing, refer to the corresponding Kebab system operation manual.	-	-

*1. Hidden icons can be displayed using Printer Management  "Setting a function icon"(P. 255).

Important!

- Some functions may not be displayed depending on the particular printer or inkset. For more information, refer to the individual function explanations.
- Depending on the Job settings, these cannot be selected (grayed out). For more information on conditions that cannot be selected, refer to  "Quick Reference Table of Conditions Preventing Function Icon Selection"(P. 328).

2.2.2 Properties

Displays the job and printer information and allows the job attributes to be edited.

Properties - Functions

[Properties] allows the following operations.

- Rename a job
- Change a full-color job to a monotone job
- Edit the settings for a special color job
- Change the UV mode settings
- Check job information
- Change the 2.5D Texture Maker settings

Properties - Screen Layout

● [Properties] screen

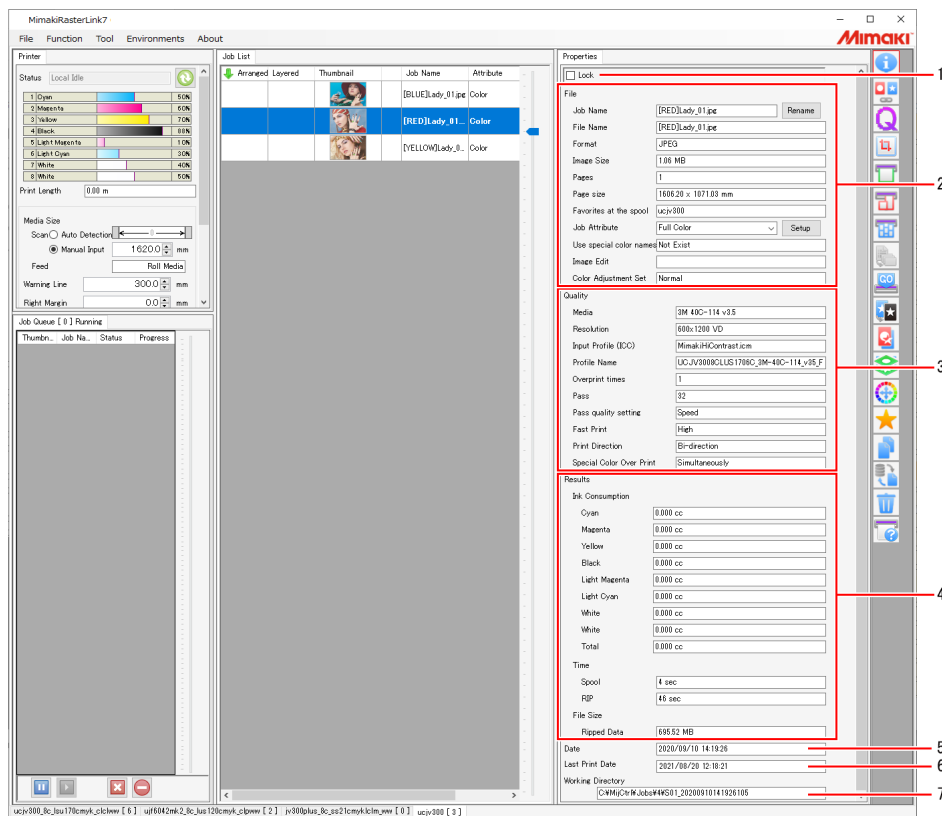

1. [Lock]

Enabling this prevents the selected job settings from being altered or deleted. A padlock icon is displayed in the [Job List] as shown below.



Important!

- Enabling this disables all functions except [Backup], [Execute].
- If even one job in a composite or arranged job is locked, all of the composite or arranged jobs will be locked.

2. [File]

Displays the selected job and original image data information.

- [Job Name] : Displays the job name. The default job name is the same as the original image data file name. The job name can be edited as required by the user ["Rename a job"\(P. 34\)](#).
- [File name] : Displays the original image data file name.
- [Format] : Displays the format of the original image data.
- [Image Size] : Displays the size of the original image data file.
- [Pages] : Displays the number of pages for the job.
- [Page size] : Displays the size of each page.
- [Favorites at the spool] : Displays the favorite applied when the job was imported.
- [Job Attribute] : Displays the following attributes depending on the printing method. The settings can be edited.
- [Full Color]

A job to be printed using the image data colors.
 - [Mono Color]

This can be set when the image data is in CMYK color mode. A job to be printed by assigning C, M, Y, or K to a specified ink color. ["Print a full-color job in monotone"\(P. 35\)](#)
 - [Special Color]

A job created using "Special plate". This cannot be changed to other attributes. ["Special plate"\(P. 134\)](#)
 - [Cut Only]

A cut data job. This cannot be changed to other attributes. ["Print & Cut"\(P. 267\)](#)
 - [2.5D Texture Maker]

A 2.5D Texture Maker job.
For more information, refer to the "2.5D Texture Maker Guide" for the corresponding printer.
- [Use special color names] : Displays special color inks (such as white and clear) used for printing the job.
- [Image Edit] : Displays the settings (such as copy) made for the job.
- [Color Adjustment Set] : Displays the color adjustment set used with the job.

3. [Print Condition]

Displays the following print conditions set in "Print Condition" ["Print Condition"\(P. 56\)](#).

- [Media]
- [Resolution]
- [Input Profile (ICC)]
- [Profile Name]
- Overprint times
- [Pass]

- [Fast Print]
- [Print Direction]
- [Special Color Over Print]
- Individual heater settings
- [Ink saving]
- [Edge Optimizer]

4. [Results]

Displays the various results after ripping and printing.

[Ink Consumption] : Calculates and displays the ink amounts consumed in printing for each individual ink. This is calculated at the following times:

- When [Ink Consumption Estimation] (☞ "Execute"(P. 127)) is used
The amount is estimated and displayed as [Ink Consumption (Estimation)].
- When ripping or printing is performed
The amount is calculated based on the ripped data. This value will be closer to the actual printing results compared to the estimated amount.

Important! The ink consumption for ripping and printing is displayed only in the following cases:

- When the [Option] window - [Job Control] - [Calculate Ink Consumption] check box has been selected
- When a printer is connected with the power turned on for ripping or printing

[Time] : Displays the time taken for individual processes (spooling, ripping, printing). The printing time indicated varies depending on the setting of [Option] - [Display] - [Improved accuracy of print completion time]. (☞ P. 250)

[File Size] : Displays the size of ripped data.

5. [Date]

Displays the date on which the job was registered.

6. [Last Print Date]

Displays the date and time when the last printing was performed.

7. [Working Directory]

Displays the name of the working folder in which job information is saved.

Properties - Operations

● Rename a job

Jobs can be renamed. Jobs should be renamed to make them easier to identify, for example if the same image has been imported multiple times or if jobs have been duplicated.

1 Enter a suitable name for [Job Name] in the [Properties] tab, then click [Rename].



- The job will be renamed.
- [Job Name] in the [Job List] will also be changed accordingly.

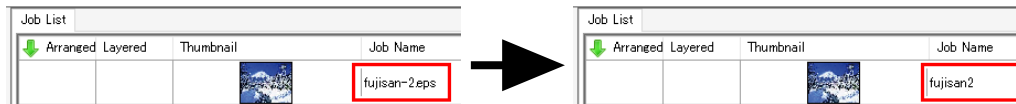

● Print a full-color job in monotone

This is used in situations such as when printing with special color inks (e.g., white or clear).

Important!

- This can be set when the original image data is in CMYK color mode.
- This operation can also be used with vector or raster images.
- [Job Attribute] of job which is set [Variable Edit] can't change.

1 Select a job for which [Job Attribute] is set to [Full Color] in the [Properties] tab.

2 Select [Mono Color] in the [Job Attribute] list.

- The [Job Attribute] dialog appears.

3 Select the color in the original image to be replaced in [Source color].

4 Select the ink color to be used in [Ink].

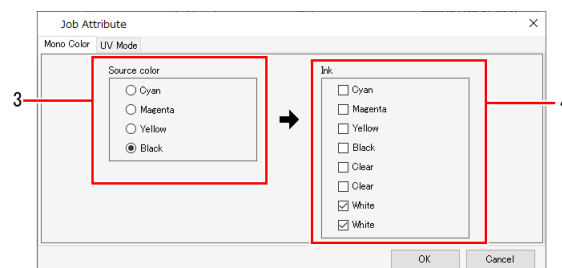

- If more than one identical color exists, that ink color can be selected multiple times.

Important!

- In the case of full-color images, information for colors other than those specified as [Source color] will be discarded and those colors will not be printed.
- The ink density for printing will use the density for [Source color].
- With a UV printer, the UV mode settings may vary depending on the ink after replacement. Recheck the [UV Mode] tab.

5 Click [OK].

- [Job Attribute] will be changed to [Mono Color] in the [Properties] tab.
- [Thumbnail] and [Attribute] in the [Job List] tab will be updated to match the conditions set.

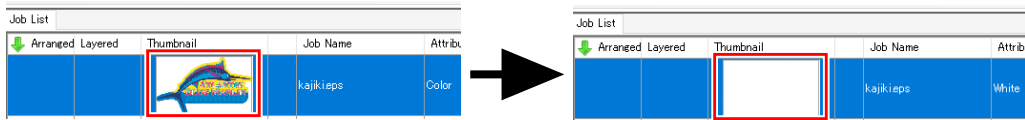

● Editing the settings for a special color job created using Special plate

The ink color and ink density can be changed for special color ink if [Job Attribute] is set to [Special Color].

- 1 Select a job for which [Job Attribute] is set to [Special Color] in the [Properties] tab.
- 2 Click [Setup] for [Job Attribute] in the [Properties] tab.
 - The [Job Attribute] dialog appears.
- 3 Set [Ink] and the corresponding ink density.

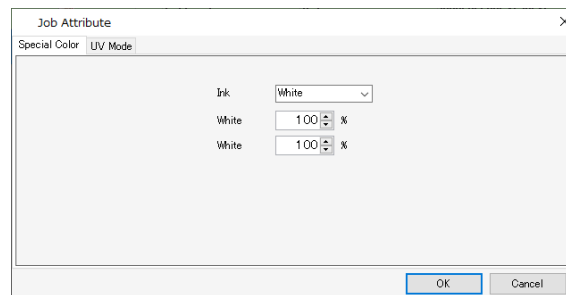

4 Click [OK].

- The [Thumbnail] and [Attribute] in the [Job List] will be updated accordingly if the ink is changed.

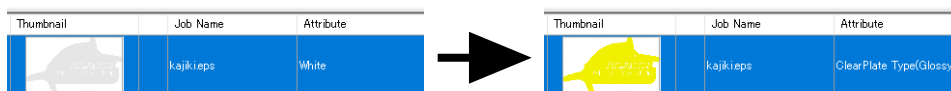

● Edit UV settings

The UV settings can be edited if using a UV printer.

- 1 Click [Setup] for [Job Attribute] in [File].
 - The [Job Attribute] dialog appears.
- 2 Set the UV mode (printing method) for printing.
 - The details that can be set will vary depending on the individual model and job attributes.
 ["UV Mode settings"\(P. 38\)](#)

3 Click [OK].

- The UV settings are applied.

● UV Mode settings

The UV Mode can be used in combination with UV printers and job attributes as follows.



UV Mode settings is not available on the following models.

- SIJ-320UV, UJV55-320

• When [Job Attribute] is "Color", or "White"



Color UV Mode cannot be set on the following models.

- JFX600

Models: UJV100, UCJV300, UCJV330, UJV100 Plus

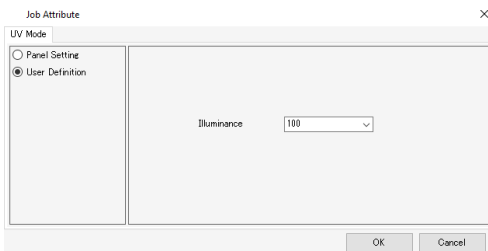

[Panel Setting] : Prints using the printer UV settings.

[User Definition] : Prints using the UV irradiation set on this screen.

Models: UJF series (Excluding UJF-7151plusII LH100)

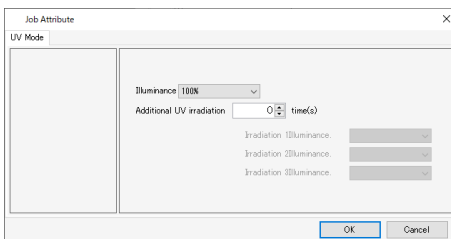

Sets the UV irradiation level and the number of times and irradiation level for additional illumination during printing.



For UJF-7151plusII LH100

- When [Job Attribute] is set "Color", glossy print is available. For more information refer to the separate "Color Printing Guide".

Models: JFX200EX, JFX200-2513, JFX500

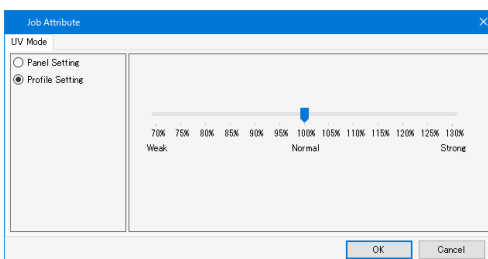

[Panel Setting] : Prints using the printer UV settings.

[User Definition] : Prints using the UV irradiation set on this screen.

- When [Job Attribute] is "Clear", glossy print is available.



Clear ink can be used to print with the following effects.

- [Glossy Print] can be printed using irradiation settings to produce a smooth, glossy surface.
- [Matte Print] can be printed using irradiation settings to produce a matte finish with a rough surface.
- [Emboss Print] allows embossing to be achieved by overlay printing with clear ink multiple times.

Model For more information on how to print using clear ink, refer to the "Clear Ink Printing Guide".

Models: UJV100, UCJV300, UCJV330, UJV100 Plus

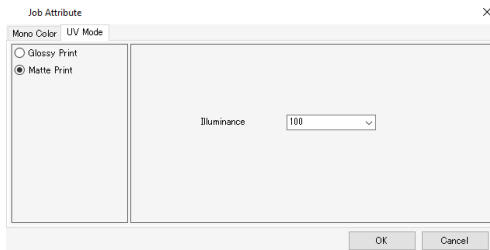

- [Glossy Print] : No setting items required.
- [Matte Print] : Illuminance can be set.

Models: UJF series, JFX series (Excluding JFX600)

[Panel Setting]

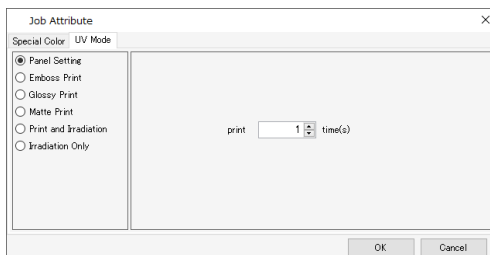

The UV illuminance will be the value set on the printer panel.

Allows the number of clear plate overlaps to be set.

[Emboss Print]

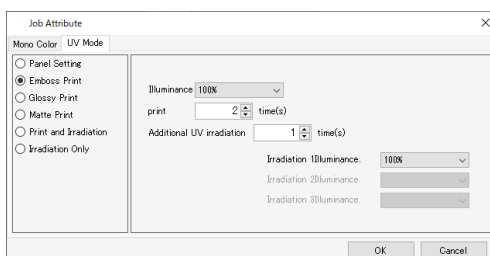

[Illuminance] : Sets the illuminance for printing.

[Print] : Sets the number of overlay printing times.

[Additional UV irradiation] : With emboss printing, the ink does not cure with irradiation alone when printing, thus necessitating additional irradiation. Set the number of irradiation cycles together with the irradiation illuminance.

[Glossy Print]

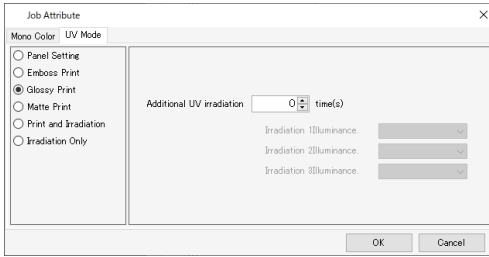

[Additional UV irradiation] : Performs additional irradiation to ensure complete ink curing after clear ink printing. The number of irradiation cycles can be set together with the irradiation illuminance.



• For JFX200EX

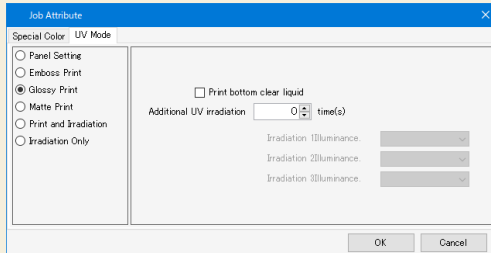

[Print bottom clear liquid]: Prints a matte finish in clear ink over the colors. For more information, refer to the separate "JFX200 Clear Ink Printing Guide".

[Matte Print]

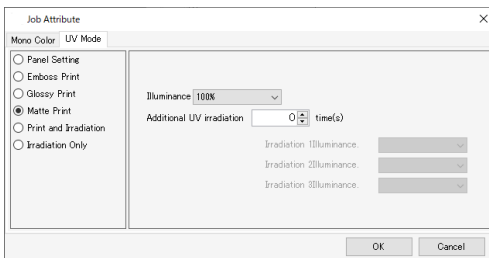

[Illuminance] : Sets the illuminance for printing.
 [Additional UV irradiation] : Set when additional irradiation is required. Sets the number of irradiation cycles and irradiation illuminance.

[Print and Irradiation]

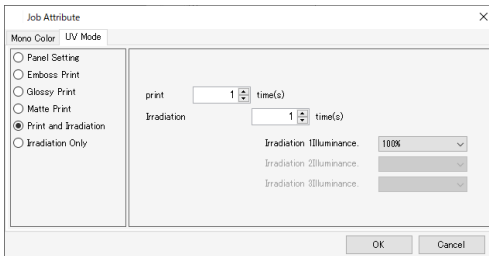

Prints clear ink without using irradiation. Allows the number of overlay printing times to be set.
 [Print] : Sets the number of overlay printing times.
 [Irradiation :] : Sets the number of irradiation cycles and irradiation illuminance after printing.

[Irradiation Only]

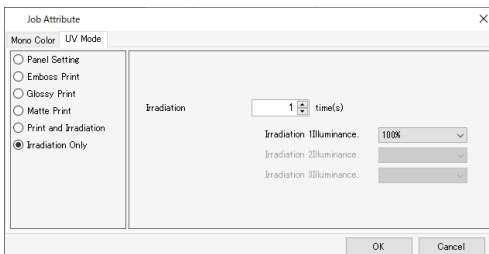

Performs irradiation only. Use additional irradiation if the ink is insufficiently cured.
 [Irradiation :] : Sets the number of irradiation cycles and irradiation illuminance.

Models: JFX600

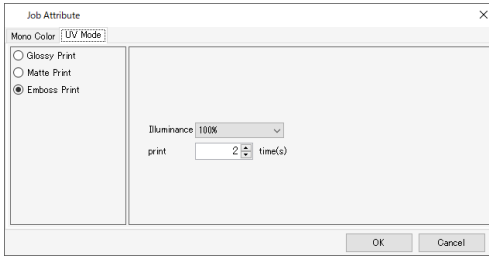

There are no setting items for [Glossy Print] and [Matte Print].

[Emboss Print]

[Illuminanc: e] : Sets the illuminance for printing.

[Print] : Sets the number of overlay printing times.

• When [Job Attribute] is "Primer"



Primer UV Mode cannot be set on the following models.

- JFX600

Models: UJF series

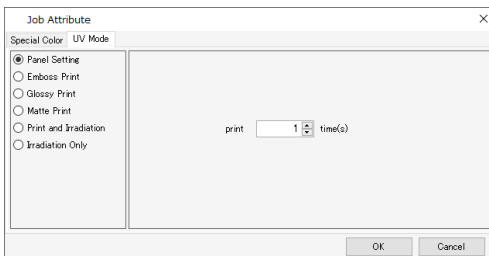

The same setting are available as when [Job Attribute] is "Clear".

Models: JFX200-2513, JFX200EX, JFX500

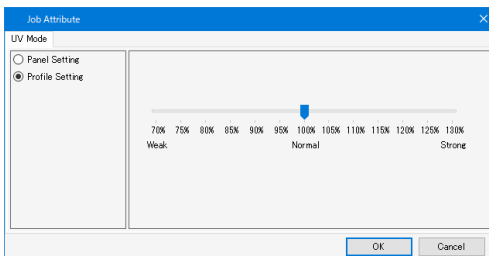

The same setting are available as when [Job Attribute] is "Color".

● Change the 2.5D Texture Maker settings

Configure the 2.5D Texture Maker settings.

For more information, refer to the "2.5D Texture Maker Guide" for the corresponding printer.

2.2.3 PrintGroup

PrintGroup - Functions

PrintGroup are a function that allows multiple jobs to be combined and printed as a single unit.

The combined jobs are referred to as a "group", and the "group" can be duplicated and printed as needed.

PrintGroup offer the following features:

- Print with other jobs placed in the margins of a split-print job
- Specify a printing order different from the input image order
- Set margins for group-level duplication

PrintGroup - Screen Layout

● [PrintGroup] Screen

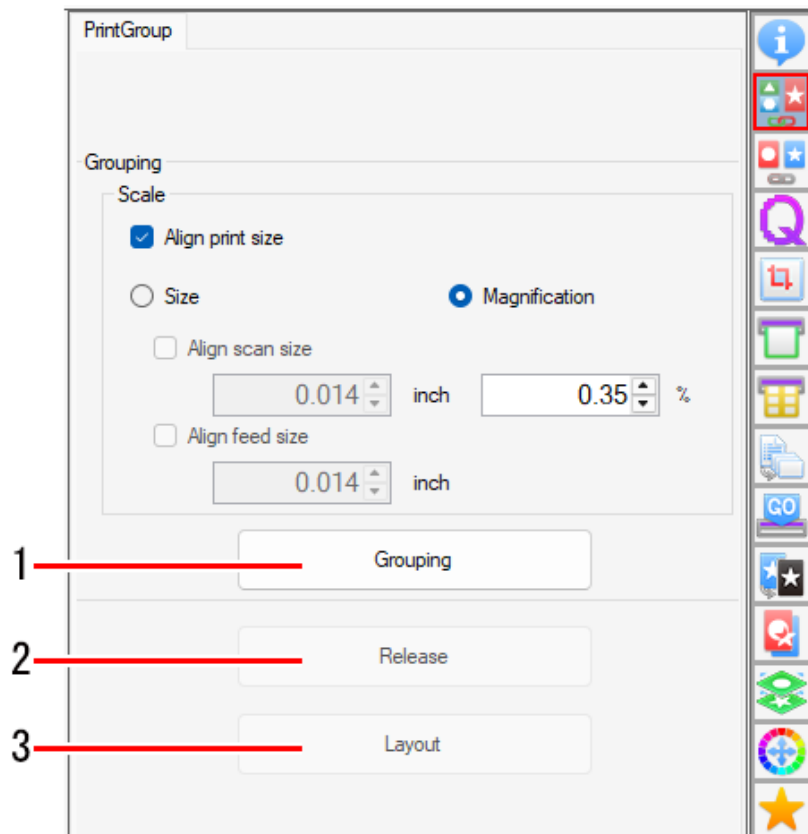

1. [Align print size]

Selecting the check box allows you to apply scale settings to all grouped images. The width and feed size can be set, or a magnification can be specified.

2. [Grouping]

Clicking this groups the multiple jobs selected from the [Job List] tab. Grouping may not be possible depending on the job settings.

3. [Release]

Clicking this ungroups the jobs selected from the [Job List] tab.

4. [Layout]

Clicking this displays the edit screen for the grouped jobs selected from the [Job List] tab.

● [Image Setting] tab

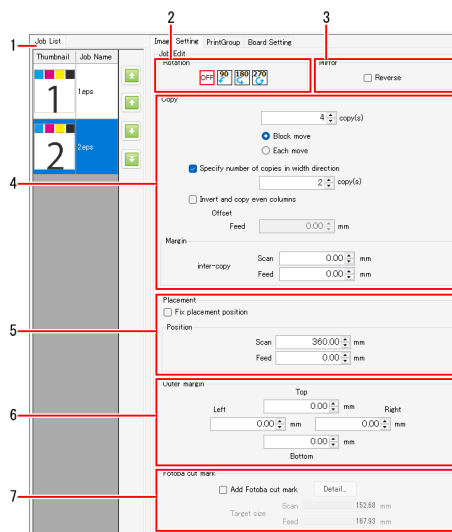

1. [Job List]

Displays the print order for grouped jobs.

The job print order can be changed using the ↑↓ controls.

2. [Rotation]

Rotates the job.

3. [Mirror]

Reverses the job.

4. [Copy]

Copies and positions the job.

- The number of copies arranged in the width direction can be specified.
- Even-numbered columns of the copied images can be reversed.
- The margins between copies can be specified.

5. [Placement]

- The placement positions can be fixed.

6. [Outer margin]

- The margins around images can be specified.

7. [Fotoba cut mark]

Selecting the check box prints cut marks used with the Fotoba Series (high-speed finishing cutter machine).

● [PrintGroup] tab

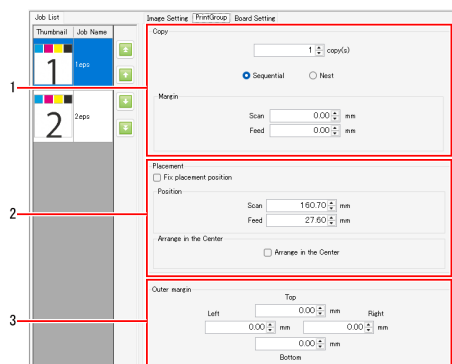

1. [Copy]

Copies and positions grouped jobs.

- The margins between copies can be specified.

2. [Placement]

- The placement positions can be fixed.
- Jobs can be arranged in the center of the media.

3. [Outer margin]

- The margins around images can be specified.

● [Board Setting] tab

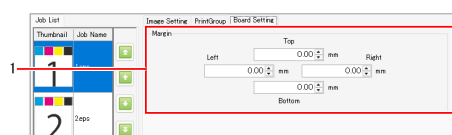

1. [Margin]

The size of the print area displayed in Layout Preview can be adjusted.

- The display area in Layout Preview will be reduced by the size of the margins.

● Layout Preview

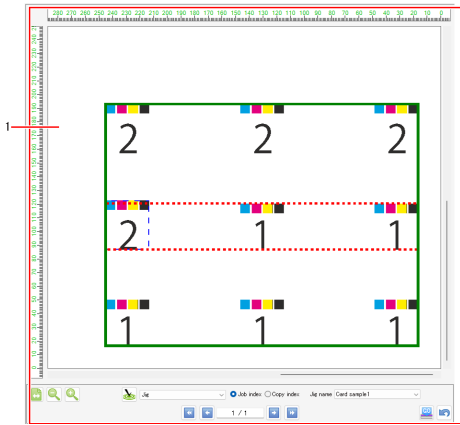

1. Preview

Displays the layout image.

2. Rearrange

- Jobs can be arranged by specifying the placement algorithm.
- Jobs can be arranged by specifying the job order or copy order.
- Jobs can be arranged at selected jig positions by selecting a jig name and specifying it in the placement algorithm.

Important! Precautions when selecting a jig name for layout in UJ330H

- When selecting a jig name and layout in UJ330H, the print will automatically be offset by the amount of the standard right/bottom media margin (or the margin after it is applied if margins are set).

PrintGroup - Operations

● Grouping jobs

1 Select multiple jobs.

PrintGroup	Arranged	Layered	Thumbnail	Job Name	Attribute	Date
				1.eps	Color	2025/08/06 18:5
				2.eps	Color	2025/08/06 18:5



- For more information on how to select multiple jobs, refer to ["Job Operations - Operations"\(P. 22\)](#).

2 Click [PrintGroup] () in the [Function] menu or from the Function icon.

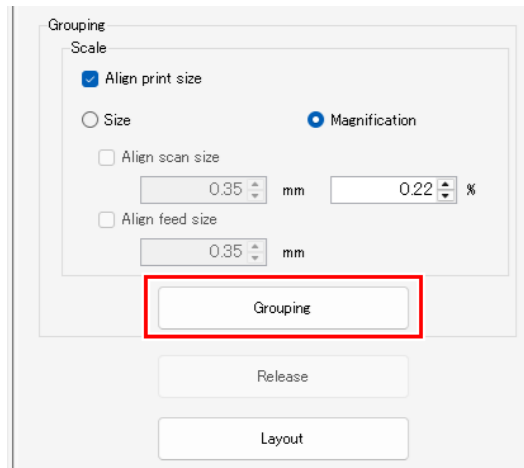
3 Click [Grouping].





- The multiple jobs selected in Step 1 are grouped.
- Lines are displayed for [PrintGroup] on the [Job List] tab.

PrintGroup	Arranged	Layered	Thumbnail	Job Name	Attribute	Date
			 1	1.eps	Color	2025/08/06 18:...
			 2	2.eps	Color	2025/08/06 18:...

● Ungrouping

1 Select the jobs to be ungrouped on the [Job List] screen.

- To ungroup all jobs, select all the jobs.

PrintGroup	Arranged	Layered	Thumbnail	Job Name	Attribute	Date
				1.eps	Color	2025/08/06 18:...
				2.eps	Color	2025/08/06 18:...

2 Click [PrintGroup] () in the [Function] menu or from the Function icon.

3 Click [Release].

Grouping

Scale

Alien print size

Size Magnification

Align scan size 0.35 mm 0.22 %

Align feed size 0.35 mm

Grouping



Release

Layout

- The selected jobs will be ungrouped.

● Editing grouping

1 Select the grouped jobs in the [Job List] screen.

PrintGroup	Arranged	Layered	Thumbnail	Job Name	Attribute	Date
				1.eps	Color	2025/08/06 18...
				2.eps	Color	2025/08/06 18...

2 Click [Layout].

Grouping

Scale

Align print size

Size Magnification

Align scan size
 mm %

Align feed size
 mm

- The Layout screen appears.

3 Set the image settings and grouping conditions.

Examples of grouped job settings

Margins between copies

Example: 4 copies

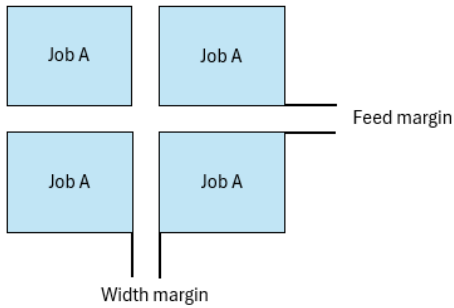

Outer margin

Example: 4 copies

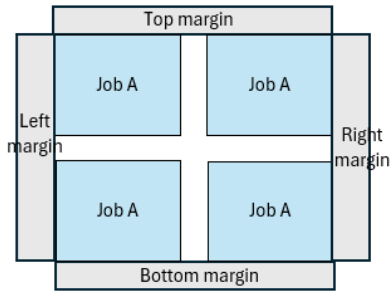

Copying reverse even-numbered columns

Example: 7 copies

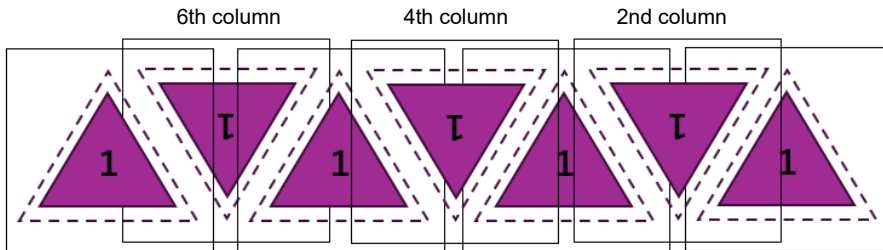

Important!

- Manually set a negative value for the margin in the width direction to prevent the print area and cut area from overlapping.

Copying grouped jobs

Example: Grouped jobs (Job B: 4 copies, Job C: 2 copies) two copies

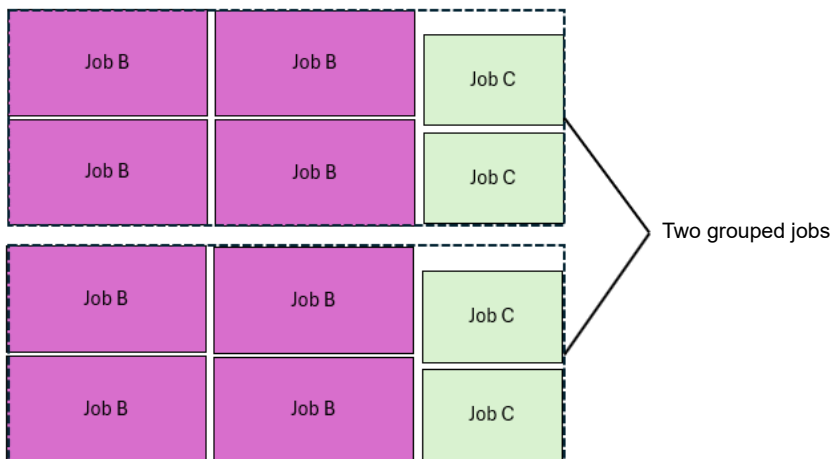

2.2.4 Arrange

Combines multiple jobs into a single job.

Arrange - Functions

With RasterLink7, printing multiple jobs all together is referred to as "arranged printing".

[Arrange] allows the following operations:

- Print multiple jobs all together.
- Arrange in the center of the media.
- Cancel arrangement.

● Conditions

Maximum number of arranged jobs

Up to 100 jobs can be arranged.

Editing conditions

Jobs with the following settings cannot be arranged:

- [Tiling]
- [Step & Repeat]

Also, jobs cannot be arranged with other groups of jobs that have already been arranged. In such cases, the arrangement must first be canceled before arranging.

Composite job arrangement

Multiple composite jobs can be arranged provided they satisfy the following conditions:

- For special color over-printing, the printing sequence for special colors and regular colors is the same for all of the arranged jobs.
- With flatbed printers, the number of printing position changes is the same for all of the arranged jobs.

Print & Cut job arrangement

Multiple Print & Cut jobs can be arranged. However, it is not possible to arrange Print & Cut jobs together with Color Only jobs or with Cut Only jobs.

Print-related settings

Jobs cannot be arranged if the following settings differ:

- [Resolution]
- [UV Mode] (with UV printers)

Jobs can be arranged if the following print-related settings differ:

However, all of the following settings will be the same as for the first job:

- [Pass]
- Overprint times
- [Halftone]
- [Follow by data]
- [Fast Print]
- [Cut after Print]
- [Heater OFF]
- Leading Margin
- [Heater Standby]
- [Distance Correction]
- [Device Adjustment]
- Fan setting
- [Pause Time per Scan]

Arrange - Screen Layout

● [Arrange] screen

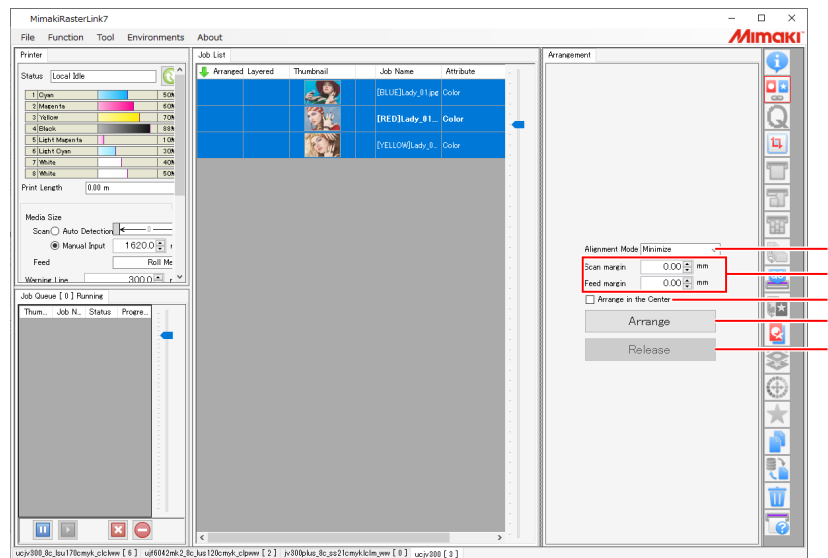

1. [Alignment Mode]

Sets the alignment mode for the group of jobs when [Arrange] is clicked.

To position jobs individually, set the arrangement, then modify the layout using "General Print" "General Print"(P. 78).

- [Sequential] : Positions jobs in the media print direction.
- [Minimize] : Positions jobs to use the media most effectively.
Jobs may be rotated automatically to optimize the layout.
- [No rotation] : Positions jobs in the same way as for [Minimize], but does not rotate jobs.
- [Minimize (Keep rotation)] : Positions jobs in the media print direction, retaining the rotation set on the Print Condition screen.

2. [Scan margin], [Feed margin]

Sets the margins between jobs. This is applied when [Arrange] is clicked.

The margins can also be changed after arranging using "General Print" "General Print"(P. 78).

3. [Arrange in the Center]

Selecting the check box positions the entire arranged job in the center of the media.

This is applied when [Arrange] is clicked.

The layout can also be changed after arranging using "General Print"  ["General Print"\(P. 78\)](#).

4. [Arrange]

Clicking this arranges the multiple jobs selected from the [Job List] tab.

Depending on the settings, it may not be possible to arrange certain jobs  ["Arrange - Functions"\(P. 49\)](#)

5. [Release]





Clicking this cancels the arrangement for the jobs selected from the [Job List] tab.

Arrange - Operations

- Print multiple jobs all together.

1 Select multiple jobs.

- For more information on how to select multiple jobs, refer to  "Job Operations - Operations"(P. 22).







Arranged	Layered	Thumbnail	Job Name	Attribute
<input checked="" type="checkbox"/>	<input checked="" type="checkbox"/>		Butterfly_p.eps	Color
<input checked="" type="checkbox"/>	<input checked="" type="checkbox"/>		Flower_p.eps	Color
<input checked="" type="checkbox"/>	<input checked="" type="checkbox"/>		Folding fan_p.eps	Color
<input checked="" type="checkbox"/>	<input checked="" type="checkbox"/>		Heart_p.eps	Color
<input checked="" type="checkbox"/>	<input checked="" type="checkbox"/>		Kimono_p.eps	Color

2 Click [Arrange] in the [Function] menu or the function icon ().

3 Set Alignment Mode, Margin, and select or unselect the Arrange in the Center check box, then click [Arrange].

Arrangement	
Alignment Mode	Minimize
Scan margin	0.00 mm
Feed margin	0.00 mm
<input type="checkbox"/> Arrange in the Center	
<input type="button" value="Arrange"/>	
<input type="button" value="Release"/>	

- The multiple jobs selected in Step 1 are arranged.
- Lines are displayed for [Arrange] on the [Job List] tab.

Arranged	Layered	Thumbnail	Job Name	Attribute
<input checked="" type="checkbox"/>	<input checked="" type="checkbox"/>		Butterfly_p.eps	Color
<input checked="" type="checkbox"/>	<input checked="" type="checkbox"/>		Folding fan_p.eps	Color
<input checked="" type="checkbox"/>	<input checked="" type="checkbox"/>		Kimono_p.eps	Color
<input type="checkbox"/>	<input type="checkbox"/>		Flower_p.eps	Color
<input type="checkbox"/>	<input type="checkbox"/>		Heart_p.eps	Color
<input type="checkbox"/>	<input type="checkbox"/>		Nadeshiko_p.eps	Color

4 Clicking the icon displays a preview with the jobs arranged.

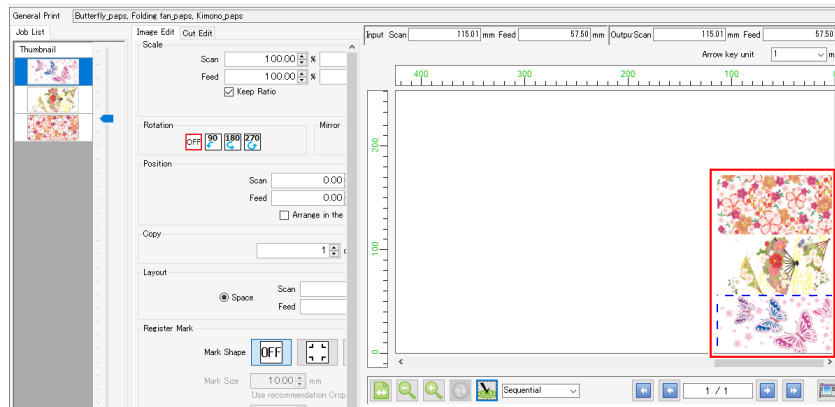

Clicking [Arrange] automatically aligns the multiple jobs selected using the specified alignment mode.

The following alignment modes are available:

- [Sequential]

Jobs will be positioned sequentially in the media feed direction. Jobs may be rotated automatically when positioning to minimize length used.

The feed margins can be set.

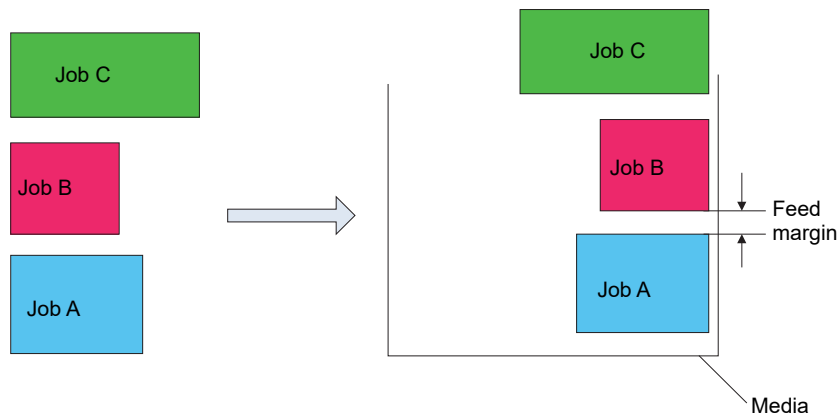

2



- While it is possible to print multiple jobs sequentially by simply printing jobs in succession, a preset margin will be inserted by the printer between each job. Sequential printing for arrangement allows the feed margin between each job to be set precisely.
- It is also possible to arrange jobs for which the number of copies has been set in [General Print]. The margin settings in [General Print] will be overwritten by the margin settings in [Arrange].

- [Minimize]

Jobs will be positioned to minimize the printing area. Jobs may be rotated automatically when positioning.

- [No rotation]

Jobs will be positioned to minimize the printing area. The sequence in which the jobs are positioned will be altered automatically. The jobs will not be rotated automatically. The [Rotation] setting will be disabled on the [General Print] screen.

- [Minimize (Keep rotation)]

Jobs will be positioned to minimize the printing area while maintaining the [Rotation] settings set on the [Print Condition] screen.

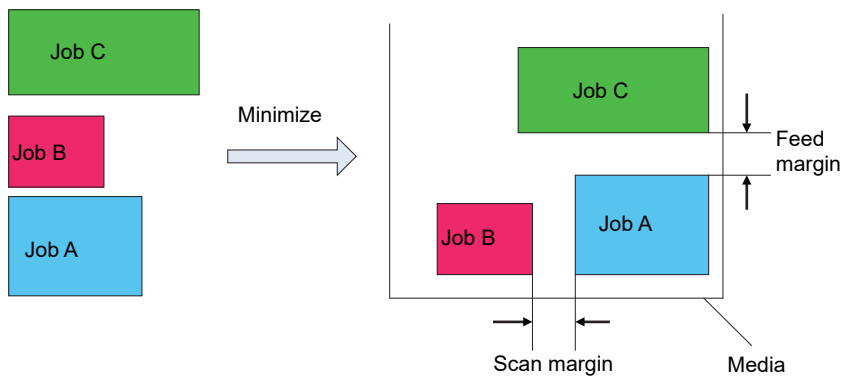

● **Arrange in the center of the media.**

1 Select the [Arrange in the Center] check box.

2 Click [Arrange].

- The arranged jobs will be positioned at the horizontal center of the medium.

- When the alignment mode is [Sequential]:

The rectangular border (dotted line in figure on left) surrounding all of the jobs is positioned at the horizontal center of the medium.

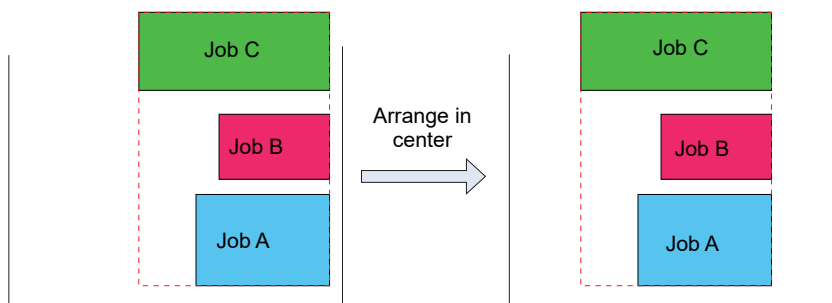

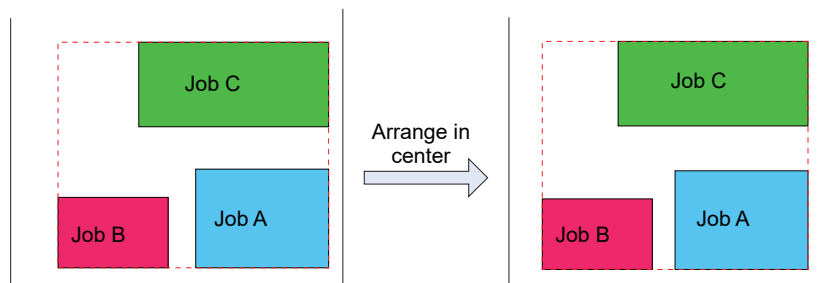

- When the alignment mode is [Minimize]:

The arranged jobs will be positioned so that the center point coincides with the horizontal center of the medium.



- Cancel arrangement.

- 1 Select the job(s) for which arrangement is to be canceled on the [Job List] screen. To cancel the arrangement for all jobs, select all the jobs.

Job List				
Arranged	Layered	Thumbnail	Job Name	Attribute
<input type="checkbox"/>	<input type="checkbox"/>		Butterfly_p.eps	Color
<input checked="" type="checkbox"/>	<input checked="" type="checkbox"/>		Folding_fan_p.eps	Color
<input type="checkbox"/>	<input type="checkbox"/>		Kimono_p.eps	Color

- 2 Click [Arrange] in the [Function] menu or the function icon ().

- 3 Click [Release].

- The arrangement is canceled for the selected jobs.

Arrangement





Alignment Mode: Minimize

Scan margin: mm

Feed margin: mm

Arrange in the Center



Job List				
Arranged	Layered	Thumbnail	Job Name	Attribute
<input checked="" type="checkbox"/>	<input checked="" type="checkbox"/>		Butterfly_p.eps	Color
<input type="checkbox"/>	<input type="checkbox"/>		Kimono_p.eps	Color
<input type="checkbox"/>	<input type="checkbox"/>		Flower_p.eps	Color
<input type="checkbox"/>	<input type="checkbox"/>		Folding_fan_p.eps	Color

2.2.5 Print Condition

Sets the print conditions.

Print Condition - Functions

[Print Condition] allows the following operations.

- Select a device profile
- Select the output settings
- Print a color pattern*1
- Select the head unit to be used*1
- Print white at higher density*1
- Set the primer and white density*1
- Set calibration
- Printing Using LamiFit Mode
- Perform color matching
- Adjust ink levels
- Fine adjust colors
- Print small characters clearly*1
- Prints by saving ink*1
- Enable image data overprint setting
- Curve smoothing rendering
- Renders pattern object with TilingType: 2 (no distortion)

*1. Not available with all models.

● Conditions

The items that are displayed and can be set in [Print Condition] will vary depending on the individual model, inkset, and job. For more information, refer to  ["Print Condition - Operations"\(P. 61\)](#).

Print Condition - Screen Layout

● [Print Condition] screen

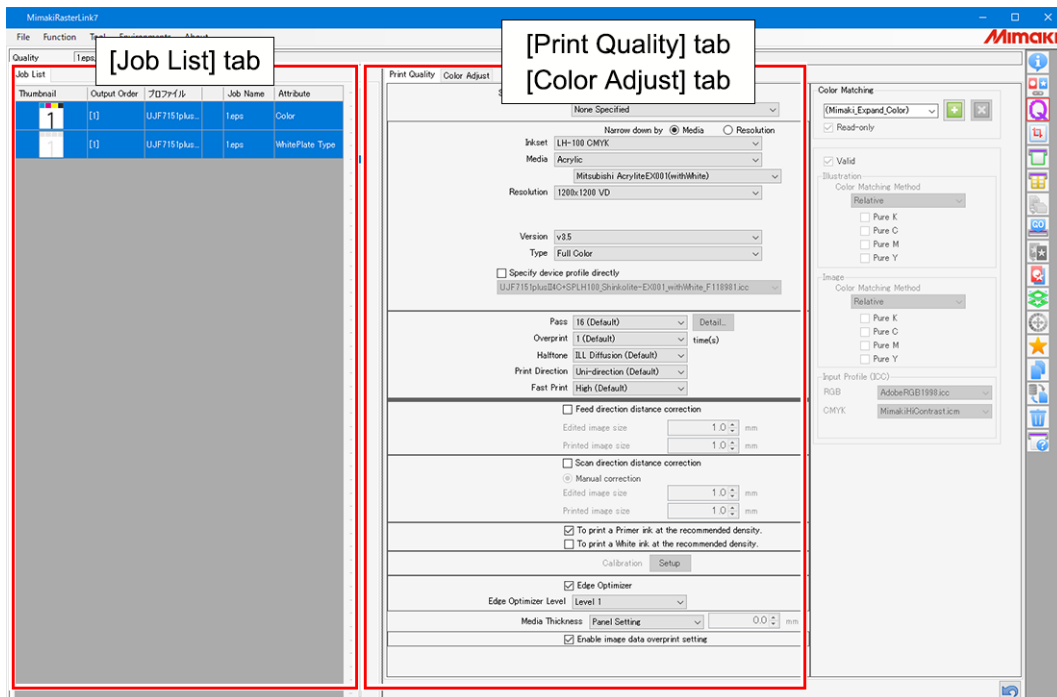

● [Job List] tab

Thumbnail	Output Order	プロフィール	Job Name	Attribute
	[1]	UJF715Iplus...	1eps	Color
	[2]	UJF715IplusI4C+SPLH100_Shinkolite-EX001_withWhite_F118981.icc	1eps	ClearPlate Type(Matte)
	[1]	UJF715IplusI4C+SPLH100_Shinkolite-EX001_withWhite_F118981.icc	1eps	WhitePlate Type

Displays the list of arranged and composed jobs.

Configure the settings for each job selected.

Important!

- When using a flatbed printer, jobs that have the same number indicated for [Output Order] on the [Job List] tab will be printed at the same time. The following settings on the [Print Quality] tab should be configured identically for jobs that are to be printed simultaneously.

- [Resolution]
- [Pass]
- [Overprint]
- [Fast Print]

Depending on the printer model, other items in addition to those above must also be set identically.



- Setting the various items with multiple jobs selected applies the same settings to all of the selected jobs.
 - Multiple jobs can be selected under the following conditions.
 - When the [Print Quality] tab is displayed
 - Jobs for which [Output Order] is identical
 - When the [Color Adjustment] tab is displayed
 - Jobs for which the same profile has been selected
- Jobs that cannot be selected simultaneously will be grayed out on the list.

● [Print Quality] tab



- Depending on your printer, some settings may not be displayed. For more information, refer to ["Available Printing Conditions, by Model"](#)(P. 324).

1. Device Profile selection

The device profile is a file containing data for adjusting print conditions and ink levels to ensure optimum quality. One device profile exists for each printer, inkset, media, and resolution.



- Device profiles can be obtained as follows.
 - Download from the official Mimaki website
 - Download using Profile Manager
 For more information, refer to the separate "RasterLink7 Installation Guide".
- Device profiles can be created using "MimakiProfileMaster3" (sold separately).



- V1 and V2 device profiles (with the ".cot" extension) which were supported by RasterLinkPro5 or earlier cannot be used with RasterLink7.

2. Output Resolution

Displays the values set for the device profile settings.

3. [Color Matching]

Matches the output colors to the input colors.

4. Estimated print time

- The estimated time when printing under the displayed conditions is displayed.

Print Time



- Print time is not displayed in the following cases.
 - For print & cut jobs
 - When pull-back printing is set
 - When not connected to a printer with the power turned on
 - For composite jobs with multiple feed
- The estimated print time displayed applies to the conditions displayed together with logical seek being disabled.
The print time displayed will differ significantly from the actual print time taken if logical seek is enabled.
- The following time is not included.
 - Ripping time
 - Flushing and cleaning time during printing

● [Color Adjustment] tab

Adjust the ink levels after color matching.

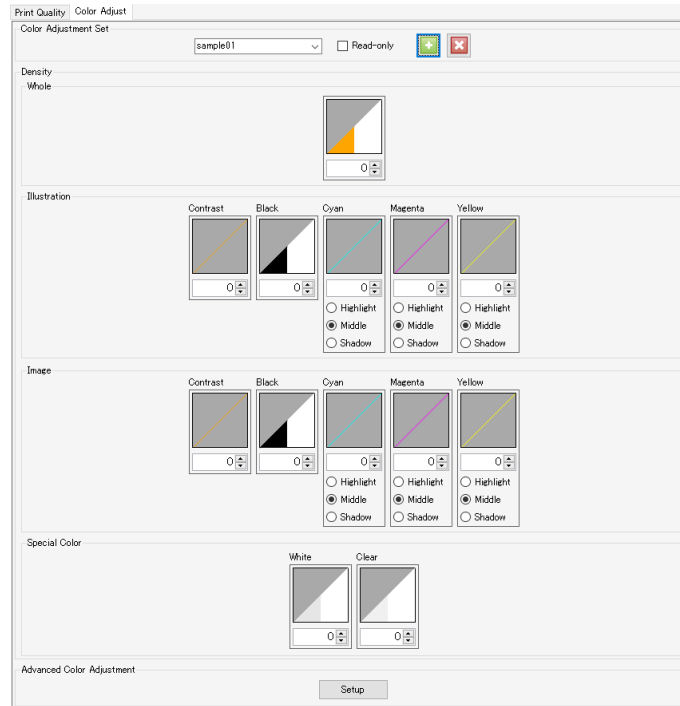

Print Condition - Operations

● Select a device profile

1 Select either [Media] or [Resolution] for [Narrow down by] in the device profile on the [Print Quality] tab.

- Selecting [Media] allows device profiles to be filtered in the following order.
Inkset ⇒ Media type ⇒ Media name ⇒ Resolution
- Selecting [Resolution] allows device profiles to be filtered in the following order.
Inkset ⇒ Resolution ⇒ Media type ⇒ Media name

2 Select the ink set used from the [Inkset] list.

3 Select the media type in the upper box and the media name in the lower box for [Media].



- The media type is classified based on the information registered in the device profile. However, [Others] is displayed for the media type in device profiles that do not include this information.
- Selecting [All] for media type allows all of the media to be selected by media name.
- If the media name displays [Base clear], [Base primer], [High-speed primer], [LD1], [LD2], or [LD3], special conditions apply. For more information on how to use, refer to "Special Conditions"(P. 334).

4 Select the output resolution from the [Resolution] list.

- Higher resolution gives higher quality but reduces the printing speed. Lower resolution increases the printing speed, but results in lower quality. Select to suit your requirements.
- [Version] displays the version of the selected device profile.
- [Type] displays the type of the selected device profile.



- The print quality and speed will vary depending on "Select the output settings"(P. 62).
- Selecting the [Specify device profile directly] check box allows the device profile to be selected using the file name without filtering.

● Select the output settings



- In this manual, the maximum feed width that can be printed per scan is called "one band".
- The values set for the device profile settings are indicated by [(Default)].

1	Pass	14 (Default)	▼	Detail...
2	Overprint	1 (Default)	▼	time(s)
3	Halftone	ILL Diffusion (Default)	▼	
4	Print Direction	Bi-direction (Default)	▼	
5	Fast Print	Normal (Default)	▼	

1 Select the number of passes (number of divisions per band) from the [Pass] list in [Output Resolution] on the [Print Quality] tab.

- A larger number of passes increases the quality but reduces the printing speed.
- The following [Pass quality setting] dialog appears when [Details] is clicked. Moving the slider to the right increases the quality but reduces the printing speed. Clicking [OK] applies the settings.

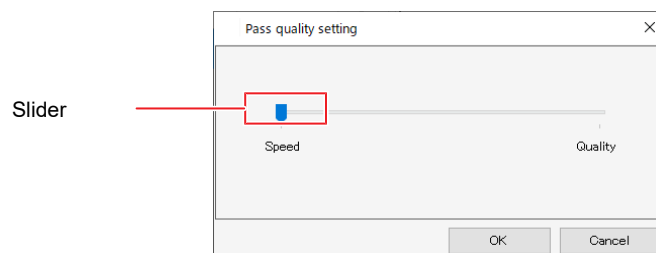

2 Set the number of scans for each printed pass in [Overprint].

- Increasing the number of scans increases the print density.

3 Select the gradation printing method from the [Halftone] list.

4 Select from the [Print Direction] list.

- [Uni-direction]: Prints only when the print head moves from right to left. This increases the quality compared to [Bi-direction] but reduces the printing speed.
- [Bi-direction]: Prints when the print head moves both left and right. This reduces the quality compared to [Uni-direction] but increases the printing speed.



- The [Bi-direction] option may not be available with certain models.

5 Select [ON] or [OFF] from the [Fast Print] list.

- Selecting [ON] reduces the quality but increases the printing speed.



- The [Fast Print] option may not be available with certain models depending on the resolution.

● Explanation of output setting items

• [Pause Time per Scan]

Sets the time for which the head pauses after each scan.
Use ink dryness as a guideline to help you decide this setting.

• [Drying time after printing]

Sets the amount of time (ink drying time) after one file is printed until printing of the next file begins.

• [Cut Media after Print]

Cuts the media after printing and separates it from the roll.



- For Print & Cut jobs, media is not separated from the roll after printing even if [Cut Media after Print] is selected.

• [Leading Margin], [Trailing Margin]

Sets margins before and after printing.



- Besides the margins set here, the printer also automatically adds margins.

• [Feed tail space]

Sets whether to feed the media past blank portions if there are blank spaces after images (at the top of the original image).

• [Heater OFF]

Sets the heater off status after printing is complete.

• [Vacuum]

Sets the media vacuum strength. If media tends to adhere to the printer too much, set the vacuum setting to low.

• [Top Blower]

Sets the top blower status.

• [Print Pinch Roller Pressure]

Sets the pinch roller pressure during printing.

• [Device Adjust Parameter] screen

- Post-heater/Fan-heater/Preheater/Print-heater

Sets various heater settings.

Click [Apply to printer] to send all temperature settings to the printer.

By setting the temperature before printing, you can reduce the heater temperature adjustment time immediately before printing.

If both Post Heater 1 and Post Heater 2 are present, Post Heater 1 cannot be set to a higher temperature than Post Heater 2. If the set temperature for Post Heater 1 is higher than that Post Heater 2, the temperature will be unified to the temperature of Post Heater 2.

- [Media Feed Speed]

Sets the media feed speed value if accurate feeding is not possible under the default media feed speed.

- [Feed Correction]

Corrects the media feeding amount if banding appears on printed images when roll media is printed while it is fed forward.

● Print a color pattern (with a roll-to-roll printer)

Color patterns are printed for checking nozzle clogging.

1 Color Pattern Print
 2 Print Position Both
 3 Print width times 1 times

1 Select the [Color Pattern Print] check box.

2 Select the position for printing the color pattern from the [Print Position] list.

- [Left Side]: Prints a color pattern on the left edge of the media.
- [Right Side]: Prints a color pattern from the print origin.
- [Both]: Prints color patterns on both the print origin and the right and left edges of the media.

3 Set the print width for the color pattern to be printed on the left side using [Print width times].

- Set in a range of 1 to 5 times.
- The color pattern print width per nozzle is 1.8 mm.



- The amount of ink consumption displayed after RIP and print does not include the ink amount consumed to print a Color pattern.

● Select a head unit to use for printing

1 Select the head unit to be used for printing in the [Use Headunit] list.

Use Headunit User Definition 1 2

● Correct the feed and scan direction distance (flatbed printers)

1 Feed direction distance correction
 2 Edited image 1.0 mm
 3 Printed Image 1.0 mm

4 Scan direction distance correction
 5 Manual correction
 6 Edited image 1.0 mm
 7 Printed Image 1.0 mm

1 Select the [Feed direction distance correction] check box.

2 Enter the feed direction distance for the data to be printed in [Edited image size].

3 Enter the feed direction distance (actual distance) prior to distance correction in [Printed Image Size].

- The feed direction print size, movement, and copy margins are corrected.

4 Select the [Scan direction distance correction] check box.

5 Select [Manual correction].

6 Enter the scan direction distance for the data to be printed in [Edited image size].

7 Enter the scan direction distance (actual distance) prior to distance correction in [Printed Image Size].

- The scan direction print size, movement, and copy margins are corrected.



- [Auto correction] is available on the following models.
 - JFX600
 - JFX200EX
 Selecting [Auto correction] prints using correction values stored on the printer.

● Printing white at higher density

Alters the white ink level and ink limit to increase the density of the white ink printed.



- This operation is useful when the actual white ink density printed is insufficient even when the ink level and ink limit has been set in [Color Adjustment].

1 Select the [Printing of the White ink at higher density] check box.

Printing of the White-ink at higher density

● Printing special ink at recommended density

When this setting is turned on in an environment using a special ink, the ink is output at the recommended density.

Example: When the recommended ink density is 70%, the special job is printed at the following density.

- Special job created at 100%: $100\% \times 70\% = 70\%$
- Special job created at 50%: $50\% \times 70\% = 35\%$



- It is recommended to turn on this function for printing operation (default setting: ON).

1 Turn on (or off) the [To print a Primer at the recommended density], [To print a white at the recommended density], or [To print a Clear at the recommended density] check box according to the color of the special ink used.

To print a Primer ink at the recommended density.

● Printing Using LamiFit Mode

Fill ink gaps with clear ink to reduce silvering during lamination.

1 Select the check box.

LamiFit : Fills ink gaps with Clear ink to reduce silvering

- Print with clear ink filled in the gaps of the color image.

● Set calibration

Important! Calibration settings will be enabled when a device profile with calibration data set is selected. Calibration data can be set using either of the following two methods:

- Using RasterLink7 [Calibration] function
- Using Mimaki "MimakiProfileMaster3" profile creation software (available separately)

1 Click [Setup] in [Calibration] within the device profile.

- A dialog appears.

2 Select the following items.

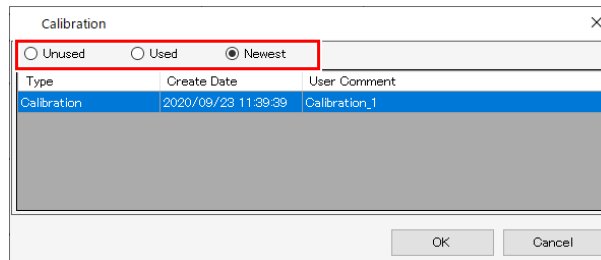

- [Unused] : Color matching is performed without using calibration or equalization data.
- [Used] : Uses calibration or equalization data selected from the list underneath.
- [Newest] : Uses calibration or equalization data with the most recent creation date. The newest data is always selected, so there is no need to reselect the data each time, even when information is added frequently.

● Make small characters clear

1 Select the [Edge Optimizer] check box, then select [Edge Optimizer Level] (1-4).

- A higher level gives sharper printing.

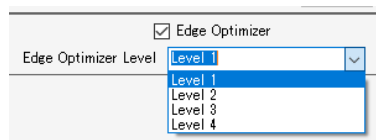

- [Edge Optimizer] is also useful when printing small characters.
- This is also applied to images and illustrations.

Important! [Edge Optimizer] is available for color ink with the exception of special color inks (white, clear).

[Edge Optimizer] is not available for jobs with the following settings.

- [Step & Repeat]
- [Tiling]
- Jobs with register marks in FineCut

● Set the media thickness

Setting the thickness automatically adjusts the printer table height for printing.

1 Select [Panel Setting] or [User Definition] in the [Media Thickness] tab.

- Selecting [User Definition] allows the media thickness to be specified.



- [Enable image data overprint setting]
Sets whether to print with the image data overprint setting enabled.
- [Curve Smoothing Rendering]
Sets whether to render curves in image data more smoothly.
- [Renders pattern object with TilingType: 2 (no distortion)]
Renders pattern objects as they appear in the design software preview.
 ["Pattern objects are printed offset"\(P. 317\)](#)

● Print with reduced ink consumption

The ink consumption can be reduced compared to when using the same device profile unmodified.

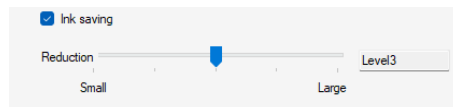

Important! Ink saving cannot be set when the following profiles are selected:

- A device profile version v3.4 or earlier
- An emulation profile
- A 2.5D Texture Maker profile or special-purpose profile such as for print bottom clear

Important! Ink saving can be set when the following settings are selected, but ink saving will not apply to the areas where those settings apply:

- Entire jobs created using special plates
- Entire jobs with single color replacement
- Entire jobs with [Valid] turned off for the color matching settings
- Objects with CMYK retention specified in the color matching settings
- Colors with color replacement set in [Color Replacement]

1 Select the [Ink saving] check box.

2 Set [Level].



Increasing the value increases the ink saving, but also increases the effects on color and print quality.

The effects of levels on color will be as follows:

- Level 1
Ink consumption is reduced without altering the original ink mixture composition as much as possible, maintaining the overall color uniformly.
- Levels 2 to 5
Areas consisting of mixtures of CMY are replaced with black ink.
Increasing the level reduces ink consumption by narrowing the reproduction color space.

● Perform color matching

In RasterLink7, adjusting the colors actually printed to match the data colors is referred to as color matching. Colors can be matched based on the ICC profile and unique data.



- In RasterLink7, vector data is referred to as "illustrations", and raster data is referred to as "images".



- In RasterLink7, color matching can be set differently for vector data and raster data. However, if effects such as blurring and transparency are added to vector data in Adobe Illustrator, some of the objects will be converted to raster data. Applying color matching to objects like this will result in color differences within the same object. In order to prevent this, the vector data and raster data color matching settings should be set identically for objects that use effects such as blurring and transparency.

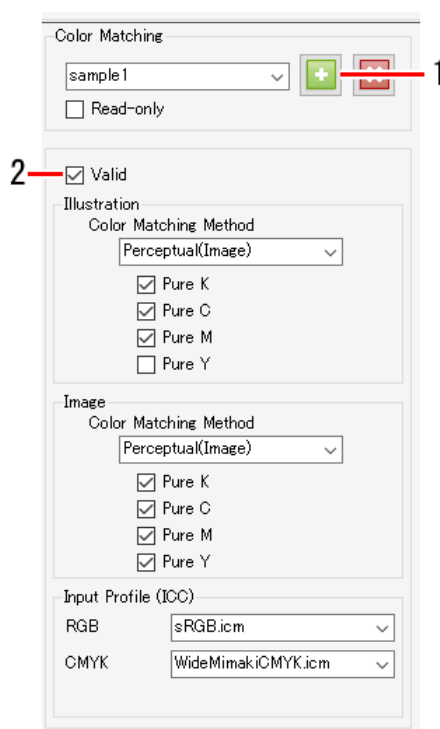

1 Enter a suitable name in [Color Matching], then click the [+] icon.

- New settings are created.

2 Select the [Valid] check box to apply the various settings.



- The settings are divided into [Illustration] and [Image].
- The [Illustration] settings are applied to vector data.
- The [Image] settings are applied to raster data.

[Color Matching Method]

[Perceptual(Image) : Suited for photographs. Color matching is performed to ensure that the overall brightness of the job is close to that of the input images.]

[Saturation(Grayscale) : Suited for illustration images. Color matching is performed to increase the overall density of the job.]

[Relative] : Color matching is performed to ensure that colors within the same color gamuts for the input profile and the device profile are as close as possible.

(Important!)

- With [Relative], colors outside the device profile color gamut will be assimilated into the colors of color gamuts that can be represented by the device profile even when the colors can be represented by the input profile. This results in blowing-out of high-saturation parts.

[Absolute] : The color matching method is the same as for [Relative]. Colors including the media color are corrected to ensure they are close to the colors of the input profile. This may sometimes result in color being printed even in areas that are white in the original image data.

[Gray Balance] : These are useful when the original image data uses CMYK color mode. CMYK adjustment is performed and color matching calculations using ICC profiles are not performed. This should be set when color matching processing is performed in the application.

[Relative(B PC)] : The color matching method is the same as for [Relative]. Performs black point compensation to improve shadow gradations.

[Pure K], [Pure C], [Pure M], [Pure Y]

- These are useful when the original image data uses CMYK color mode. Color matching using an ICC profile may result in color mixing when printing, even when the colors in the original image data have been set as C, M, Y, or K mono colors. Selecting each check box allows printing without color mixing occurring if C, M, Y, or K mono colors have been set.

[Input Profile (ICC)]

- Sets the input profile. Profile Manager can be used to install a target profile if available.
- If a profile is embedded in the original image data, the [Embedded Profile] check box is displayed. Selecting this check box uses the embedded profile preferentially as the input profile.

● **Adjust ink levels**

Adjust the ink levels after color matching processing on the [Color Adjustment] tab.

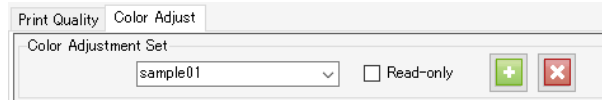

1 Enter a suitable name in [Color Adjustment Set] on the [Color Adjustment] tab, then click the  icon.



- [Color Adjustment] is dependent on the device profile. A registered [Color Adjustment Set] will not be displayed if a different device profile is selected. Even if the [Color Adjustment Set] name is the same, it will be treated as a different adjustment file if the device profiles differ. Take care when naming files.
- [Color Adjustment] cannot be edited if [Standard] is selected.
- The number of color adjustment sets that can be created is up to 300 for all printer settings registered in RasterLink7.

2 Set the density.



- The ink levels can be adjusted for special inks such as white and silver in addition to CMYK inks.

[Whole]

- This alters the ink limits set in the device profile by the same ratio for each ink. This is useful if the overall ink is too dense or too thin. The ink limits are altered by the factors set here. Settings between +1% and 50% increase the ink, but the ultimate ink limit cannot exceed 100%.

Example: When the cyan ink limit is set to 70% in the device profile

[Whole] value	Cyan ink limit
-50%	35%: $(70\% \times (100 - 50)\% = 35\%)$
-10%	63%: $(70\% \times (100 - 10)\% = 63\%)$
+40%	98%: $(70\% \times (100 + +40)\% = 98\%)$
+50%	100%: $(70\% \times (100 + 50)\% = 105\%)$ <ul style="list-style-type: none"> • While the calculation results in a value of 105%, the ultimate ink limit cannot exceed 100%, so this becomes 100%.

[Illustration]

- Sets the ink densities used with vector data.
- The following setting methods are available.

[Contrast] Alters the contrast in a range of -50% to +50%.	-50% to -1% Direction in which colors do not vary. +1% to +50% Direction in which colors vary significantly. It increases vibrancy, but gradations may tend to be blown out in high-density parts.
---	---

<p>[Black]</p> <p>Alters the black ink and cyan/magenta/yellow ink levels in a range of -50% to +50%. Use K-CMY adjustment if you require more detailed settings.</p>	<p>-50% to -1%</p> <p>Reduces the black ink limit by the ratio set.</p> <p>0%</p> <p>Enables detailed setting K-CMY adjustment. (The K-CMY adjustment setting is disabled except for 0%.)</p> <p>+1% to +50%</p> <p>Increases the black ink level and reduces the cyan/magenta/yellow ink levels.</p>
<p>[Cyan]</p> <p>[Magenta]</p> <p>[Yellow]</p> <p>Alters the cyan/magenta/yellow ink levels in a range of -50% to +50%. This is useful when adjusting hue. The ink levels are changed for middle parts, but the ink limits cannot be changed.</p>	<p>[Highlight]</p> <p>Alters the ink level primarily for brighter parts.</p> <p>[Middle]</p> <p>Alters the ink level primarily for parts around 50%.</p> <p>[Shadow]</p> <p>Alters the ink level primarily for denser parts.</p>

[Image]

- Sets the ink densities used with raster data.
- The setting methods are the same as for [Illustration].

[Special Color]

- Sets the ink densities used with special colors.
Alters the special color ink level in a range of -50% to +50%. The ink limit cannot be changed. Special color density adjustment is available when using v3.3 profiles or later.

● Fine adjust colors

Clicking [Setup] allows detailed settings for ink limits, linearization, special color ink limits, and adjusting K-CMY mixing ratio.

- [Ink Limit]

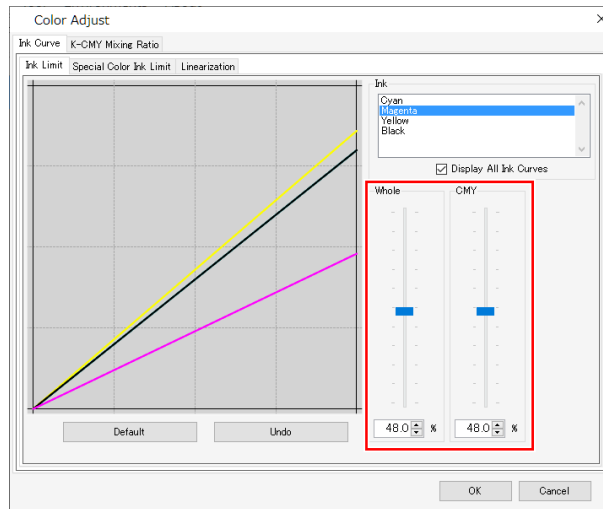

Adjust the ink limit sliders for each of the process color inks (cyan, magenta, yellow, black, etc.). [Whole] sets the ink limits for each color. [CMY] is the ink limit used when three or more inks are mixed together. The overall ink limit forms the CMY color ink limit.

This setting can be used to limit the ink if ink bleeds in areas where three or more colors intermix.

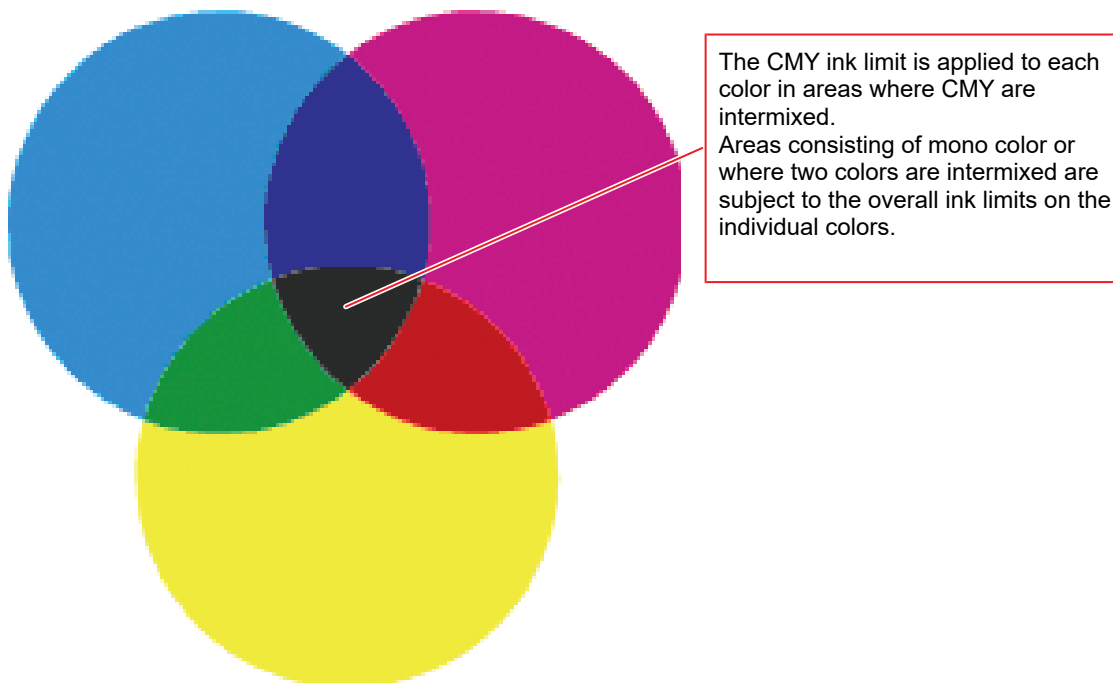

C0,M0,Y0 Using the respective overall cyan, magenta, and yellow limits
 C1,M1,Y1 Using the respective 3-dimensional cyan, magenta, and yellow limits

- [Linearization]

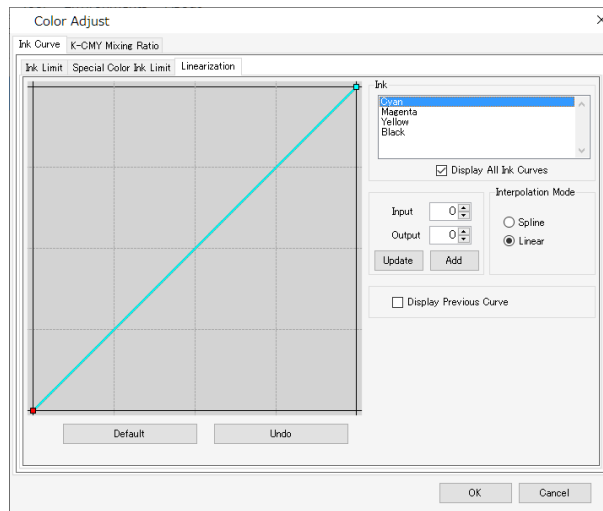

Edit the middle tone density curves for each of the process color inks (cyan, magenta, yellow, black, etc.). This adjusts the tones to ensure smooth gradations are printed for each ink. The maximum density (ink limit) can also be altered here, but this should not be changed, as this makes ink limit adjustment more difficult.

- [Special Color Ink Limit]

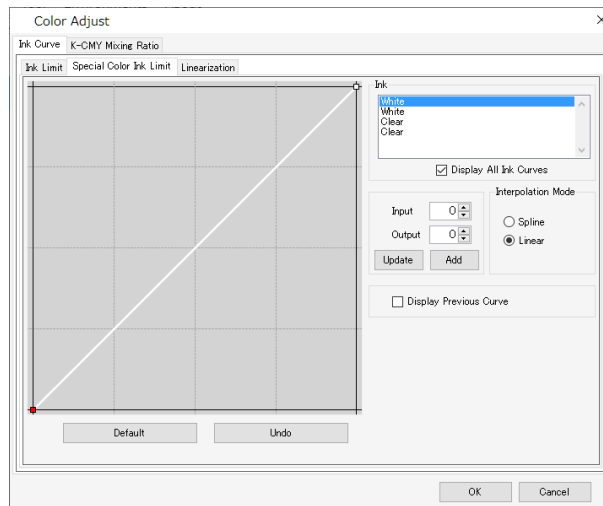

Adjust the densities for special color inks such as white, clear, and silver. Initially, the densities set in [Input] are used, but the curves should be adjusted on this screen if there is insufficient variation in the middle tone densities, such as in gradations.

- [Enable K-CMY Mixing Ratio]

Alter the curves for the black, cyan, magenta, and yellow usage ratios. Changes can be made for illustrations and images respectively. When the input data is RGB mode, and when excessive ink tends to be used in shadow areas, this adjustment can reduce the amounts of cyan, magenta, and yellow used and increase the black, without changing the shadow tone appearance significantly.



- This setting cannot be used unless black is set to 0% for [Density] on the [Color Adjustment] tab.

Without adjustment

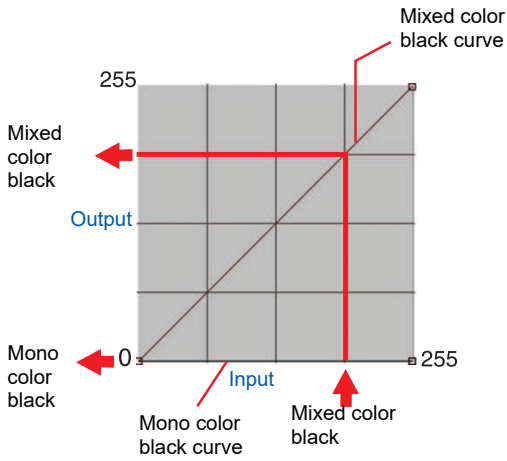

With adjustment

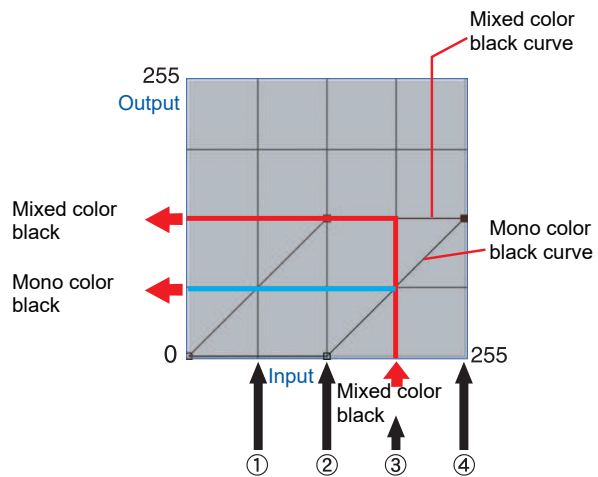

Adjusted curve values

	Input color				Mixed color black		Mono color black		Output color				Explanation
	A		B		Input	Output	Input	Output	C	M	Y	K	
	C	M	Y	K									
(1)	64	85	64	5	64	64	64	0	64	85	64	5	Unchanged
(2)	128	150	160	5	128	128	128	0	128	150	160	5	Unchanged
(3)	200	192	200	5	192	128	192	64	136	128	136	69	CMY partially changed to K
(4)	255	255	255	5	255	128	255	128	128	128	128	133	CMY partially changed to K

Calculations for (3)

C $200 - 192 + 128 = 136$

M $192 - 192 + 128 = 128$

Y $200 - 192 + 128 = 136$

K $5 + 64 = 69$

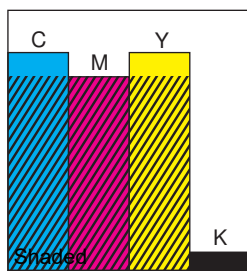

Shaded portions indicate CMY mixed with black.

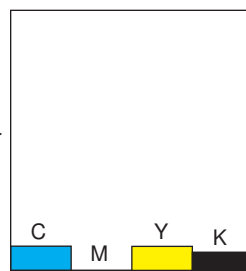

Remove mixed color black input from CMY.

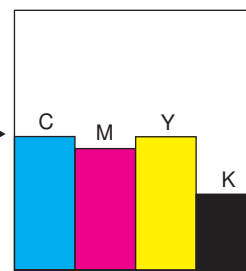

- Add mixed black output to CMY.
- Add mono color black output to K.

2.2.6 Crop

Crops part of a job.

Crop - Functions

[Crop] allows the following operations.

- Crop a job

Important! • [Crop] is not available for jobs with [Variable Edit] enabled.

Crop - Screen Layout

• [Crop] screen

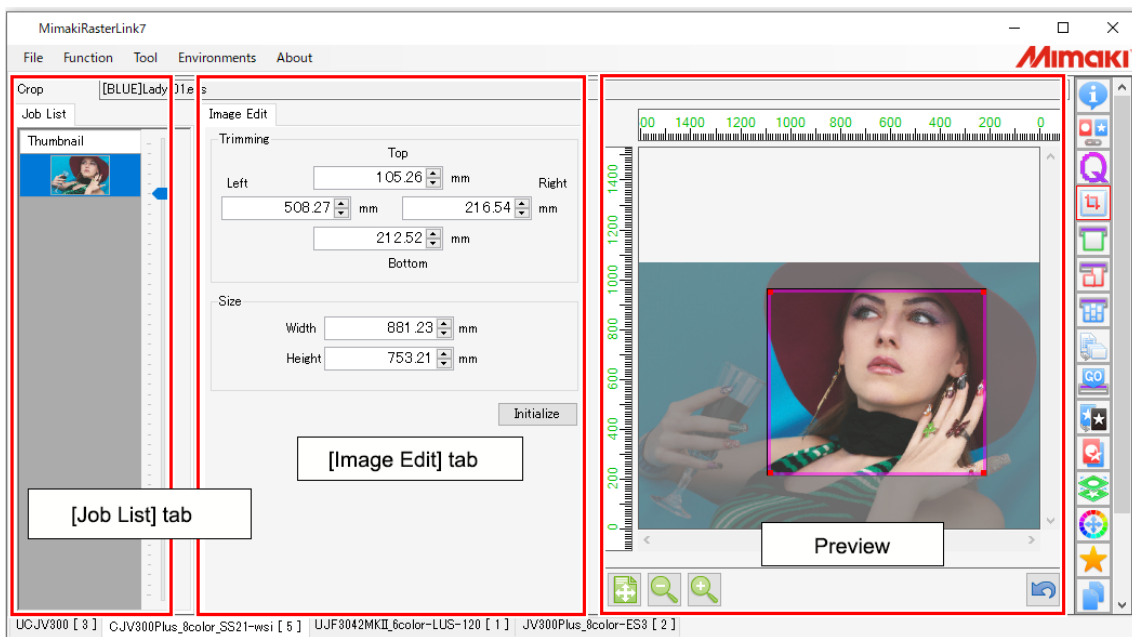

• [Job List] tab

If multiple jobs are selected in the [Properties] function, the [Job List] tab displays the multiple jobs selected. If [Crop] is used, select one job from the [Job List] tab.

Important! • Multiple jobs cannot be handled together with [Crop].

• [Image Edit] tab

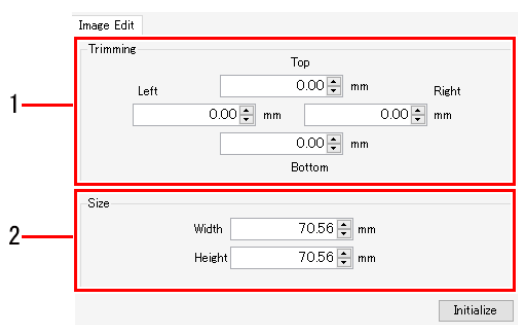

1. [Trimming]

Sets the range for cropping the job.

2. [Size]

Sets the size for cropping a job.

Crop - Operations

● Crop a job



- Enlarging or reducing jobs for example using the [General Print] function will enlarge or reduce the range cropped using [Crop].
- [Trimming] and [Size] should be set based on the size of the original image.

Set the cropping range

1 Set the cropping positions in [Trimming] on the [Image Edit] tab.

[Top] : Distance from the top edge of the job

[Left] : Distance from the left edge of the job

[Right] : Distance from the right edge of the job

[Bottom] : Distance from the bottom edge of the job

Set the cropping size

1 Set [Width] and [Height] in [Size] on the [Image Edit] tab.

- The job will be cropped to the specified size with respect to the origin position.

Set cropping lines using a mouse

- 1 Drag and drop the pink lines on the preview.

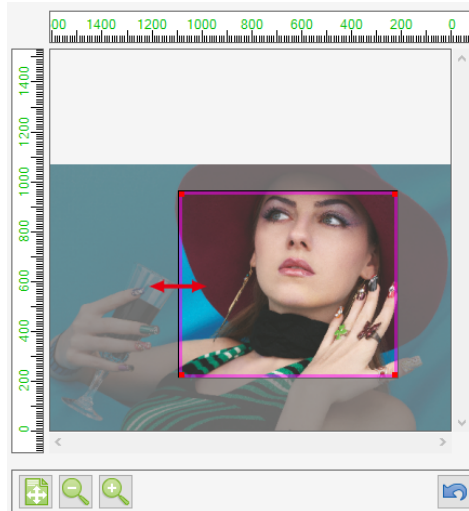

Initialize the settings

- 1 Click the [Initialize] icon on the [Image Edit] tab.



Jobs spanning multiple pages

- Thumbnails and previews display the images on the first page of multi-page jobs.
- [Trimming] and [Size] settings are applied to all pages of multi-page jobs. Settings cannot be changed for individual pages.

2.2.7 General Print

Sets basic parameters such as job size, position, and number of copies before printing.

General Print - Functions

[General Print] allows the following operations.

- Enlarge and reduce jobs
- Rotate jobs
- Reverse jobs
- Deskew
- Move jobs
- Copy a job
- Set margin between jobs
- Set the printing pages
- Set printed area
- Set register marks
- Print cut lines
- Set Fotoba cut marks
- Set the XY slitter
- Set information labels
- Print



- The cut conditions can be set if a print & cut machine or cutting device is linked. For more information, refer to  ["Print & Cut"\(P. 267\)](#).

General Print - Screen Layout

● [General Print] screen

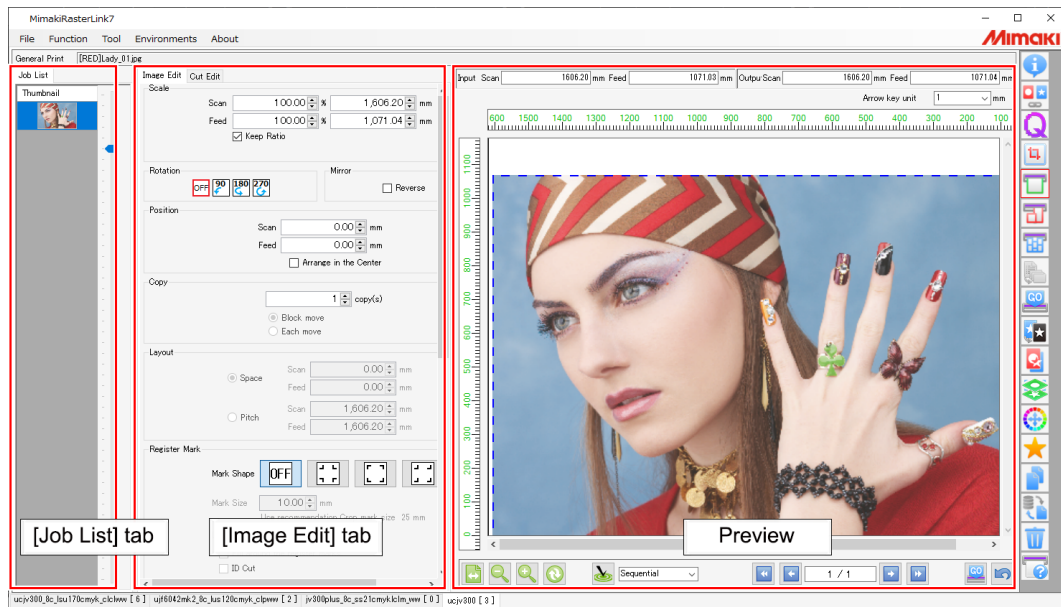

● [Job List] tab

Displays the arranged job.

The various settings for the selected job can be edited on the [Image Edit] tab.

● [Image Edit] tab

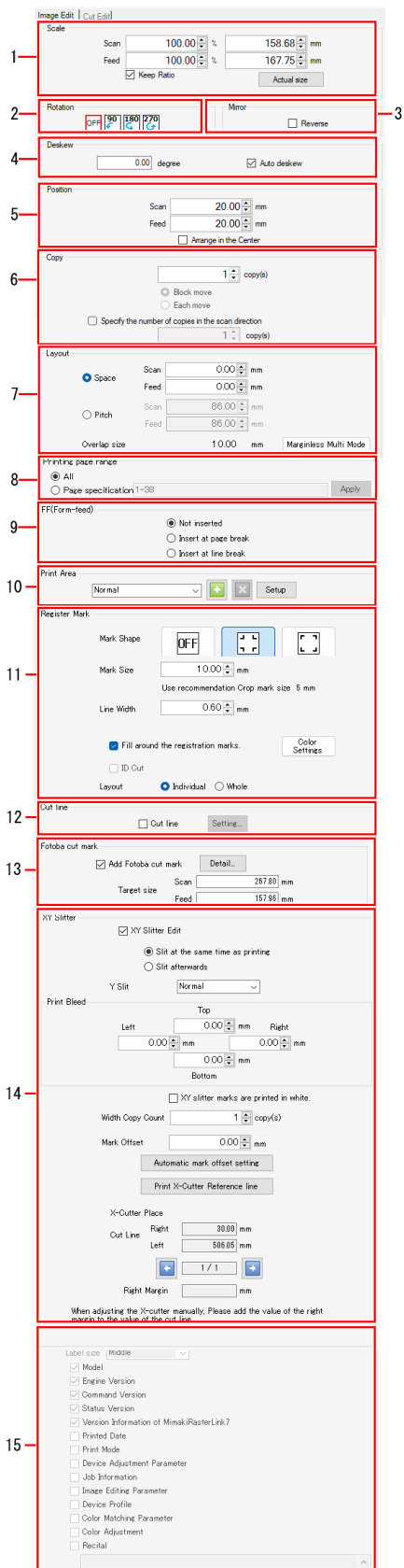

1. [Scale]

Enlarges and reduces the job.

2. [Rotation]

Rotates the job.

3. [Mirror]

Reverses the job.

4. [Deskew]

Tilts the job in the range of -45° to +45°.

5. [Position]

Sets the origin position for each job. Selecting the [Lock the trimming position] check box locks the trimming origin position in the display.

6. [Copy]

Copies and positions the job.

7. [Placement]

Specifies the layout of arranged jobs and copied jobs.

8. [Printing page range] (with multi-page jobs)

Sets the page(s) to be printed in the case of multi-page jobs(*).

9. [FF (Form-feed)] (for multi-page jobs)

Sets how form-feed code is sent.

10. [Print Area] (with flatbed printers)

Sets the valid print area to match the size of the media to be printed.

11. [Register Mark]

Sets register marks.

12. [Cut line]

Selecting the check box prints cut lines around the job.

13. [Fotoba cut mark]

Selecting the check box prints cut marks used with the Fotoba Series (high-speed finishing cutter machine).

14. [XY Slitter]

Selecting the check box prints marks and reference lines for slitting.

"Set the XY slitter"(P. 100)

15. [Information Label]

Selects information to be printed.

(*) Jobs that contain multiple images within a single file, such as PDF and TIFF multi-page files, are referred to as multi-page jobs.

● Preview

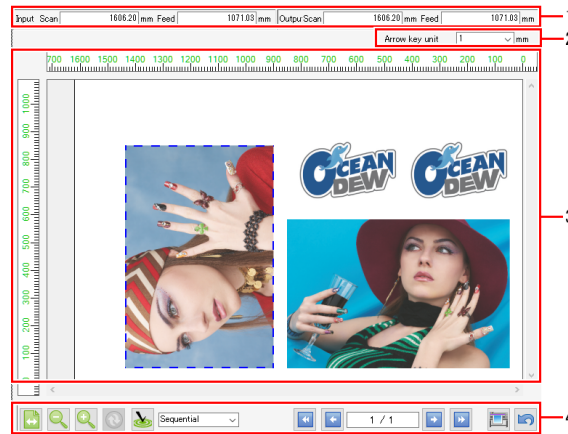

1. [Input], [Output]

[Input] displays the original data size of the selected job.
[Output] displays the size to be output.

2. [Cursor Key Unit]

The job selected by clicking in the preview can be moved by using the cursor keys on the keyboard. This setting allows you to specify the amount by which the job moves each time a cursor key is pressed.

3. Layout Preview

Displays the layout in which the job(s) will be printed.

The valid print area (within the media) is shown in the layout preview as white, and areas outside this are shown as gray.

The following operations can be performed on jobs selected individually in the layout preview using the mouse. (Multiple jobs cannot be selected simultaneously.)

- Edit the settings for the various items in [Image Edit]
- Drag and move jobs
- Move jobs using the cursor keys

With a flatbed printer

- When multiple jobs have been arranged or copied, they may not fit on a single panel, making it necessary to print several times.

In such cases, click the  icon to create a new panel on which the jobs can be placed.

- If there are multiple panels, the display indicating the number of panels at the bottom of the screen changes to red. The [←] [→] [↶] [↷] icons can be clicked to select the individual panel to be previewed.



4. Icons

**Display using media width**

Displays the layout preview width using the media width.

**Zoom out**

Reduces the layout preview display size.

**Zoom in**



Increases the layout preview display size.

**Refresh media width**

Displayed when using a roll-to-roll printer.

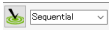
Acquires the media width from the printer and refreshes the valid print area displayed in the layout preview.

**Optimize**

Selecting an alignment mode  P. 50, then clicking the  icon allows jobs to be positioned using the selected alignment mode. The margin settings set in Image Edit are used.

If multiple jobs cannot be fitted on a single panel when using a flatbed printer, a new panel is created automatically on which the remaining jobs are placed.

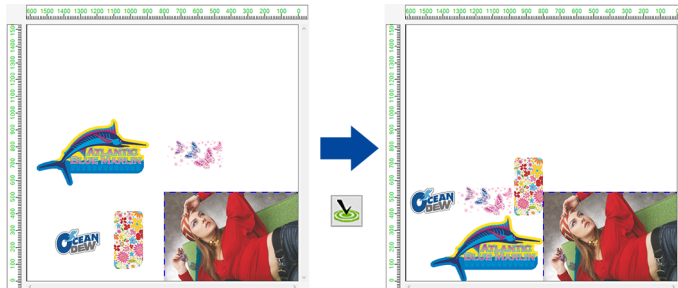
**Execute**

Rips and prints.

The processing used for execution can be set in [Option] - [Job Control] ( P. 240).

**Undo**

Restores the settings for when the [General Print] screen was first opened.

General Print - Operations

● Enlarge and reduce jobs

1 Set [Scan] and [Feed] for the job to be printed for [Scale] on the [Image Edit] tab.

- [Scan] and [Feed] can be set as ratios (%) or size.
- Selecting the [Keep aspect ratio] check box enables jobs to be enlarged or reduced while retaining the aspect ratio of the original image.

● Rotate jobs

1 Select [Rotation] on the [Image Edit] tab.

- This allows the angle of counter-clockwise rotation to be set.
- Select one of the following angles.



● Reverse jobs

1 Select the [Reverse] check box in [Mirror] on the [Image Edit] tab.



If a combination of mirroring and rotation is used, the job will be reversed before being rotated.

- With 0° rotation



- With 90° rotation



● Deskew

Deskew (manual input)

This is used when printing skewed media or material positioned at an angle to the table.

Important! • It cannot be used in combination with [Variable Edit].

1 [Deskew] on the [Image Edit] tab is used to set the job angle.

- This can be set in the range of -45° to $+45^\circ$.
- This can be set in conjunction with [Rotation].



- If [Deskew] is applied, the right-hand and lower positions of the job after skewing will be the same as before skewing.

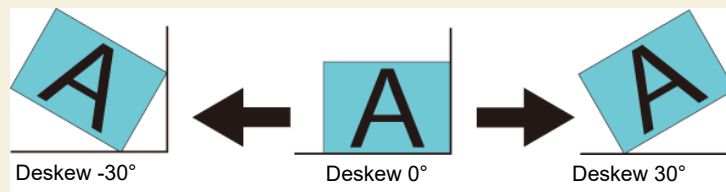

- The [Rotation] and [Deskew] angles are applied in the counter-clockwise direction.

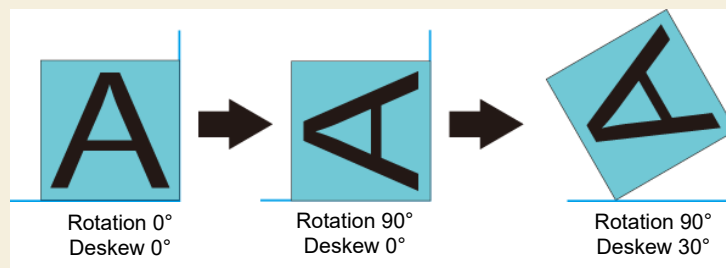

- In the case of arranged jobs, the skew angle can be set individually for each job.
- If there are two or more copies or if a job spans several pages, all jobs will be skewed with the same angle.

Important!

- The register marks set in [Register Mark] cannot be skewed. Register marks will be added to the image rectangle after the job has been skewed.

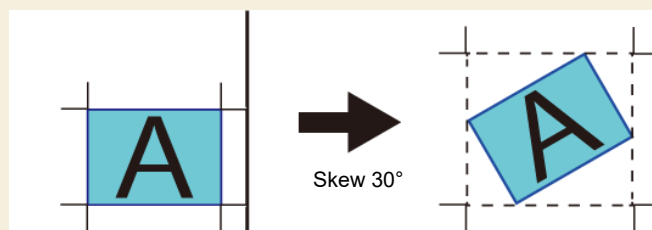

- The information set in [Printed Information Label] cannot be skewed.
- If [Crop] (👉 "Crop"(P. 75)) has been set, the job will be skewed after cropping.
- The [Deskew] value will be disabled if [Tiling] or [Step & Repeat] is set after [Deskew] has been set in [General Print].

Important!

- Skewing jobs will cause outlines and straight lines to become slightly jagged. Jagged edges will become particularly noticeable when the original image is raster data with low resolution. When the original image is raster data, data should be created using a resolution close to the print resolution.

Auto deskew (UJV100Plus)

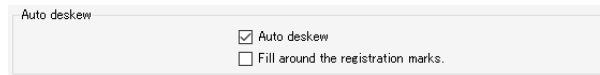

Auto deskew

Auto deskew

Fill around the registration marks.

- **[Auto deskew]**

This setting is available when the pull-back printing setting is enabled in the [Composite] function.

 [P. 150](#)

When the check box is on, a detection register mark is printed on the first image to be printed, and after the media is pulled back, that register mark is imported to automatically deskew the image and the next print will be performed.

- **[Fill around the register marks]**

The areas around the register marks can be filled in using red. This enables the register marks to be detected if they cannot be correctly detected on media whose background color is not white.

● Move jobs

Drag and move jobs

- 1 Select a job to be moved in the preview.
- 2 Drag the job to the desired position.

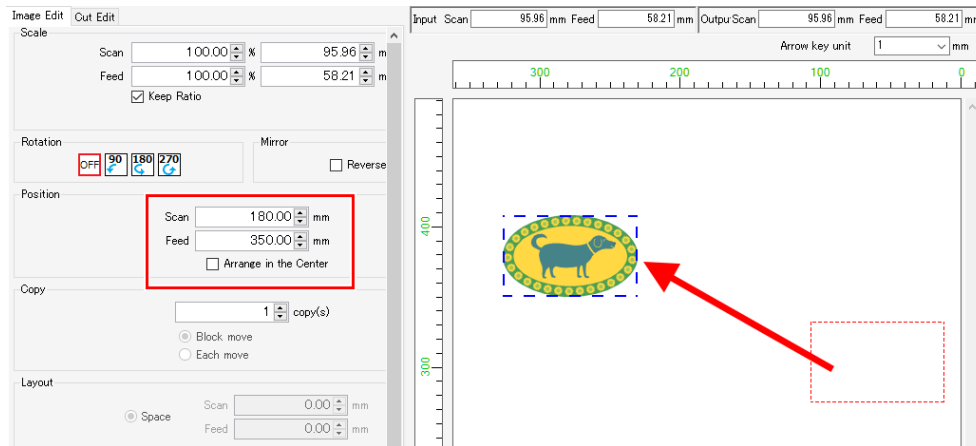

- The origin position of the job is displayed in [Scan] and [Feed].

Set the job origin position

- 1 Set [Scan] and [Feed] for [Move] on the [Image Edit] tab.

- The origin position of the job is moved by the [Scan] and [Feed] size set here.

Position a job in the center of the media

- 1 Select the [Arrange in the Center] check box for [Move] on the [Image Edit] tab.

- If the job has been copied or arranged, the entire area will be positioned in the center of the media in the same way as in "Arrange in the center of the media."(P. 54).

Move a job to the trimming origin position (With flatbed printers)

- 1 Select the [Lock the trimming position] check box for [Move] on the [Image Edit] tab.

- The trimming origin position is locked in the display.

Important! The [Lock the trimming position] function cannot be used in the following cases.

- Arranged jobs
- Multi-page jobs
- When [Arrange in the Center] is enabled
- When two or more copies are set
- When register marks are printed
- Print cut lines
- When using jig printing
- When using tiling
- When using step & repeat printing
- When using Kebab jig printing

● Copy a job

Copy a job

1 Select the number of copies to be made using [Copy] on the [Image Edit] tab.

- The job is copied and automatically positioned.



The method for moving the copied image(s) can be specified from among the following:

- Block move: Allows all of the copied images to be moved together.
- Each move: Allows the copied images to be moved individually.



- If [Specify the number of copies in the scan direction] is selected when [Block move] is selected, the layout will wrap based on the specified number of copies.

Move all copied jobs

1 Select the number of copies required using [Copy] on the [Image Edit] tab.

2 Select [Block move].

3 Set [Scan] and [Feed] for [Move] on the [Image Edit] tab. Images can also be moved by dragging on the preview.

- All the copied jobs are moved by the [Scan] and [Feed] size set here.



- With arranged jobs, the move method selection is not displayed, and is set to [Each move]. Jobs should be selected then copied or moved individually.
- For multi-page jobs, the number of copies applies to all pages. A different number of copies cannot be set for individual pages.
- Jobs set to [Variable Edit] cannot be copied.
- The maximum number of prints that can be made at once is 4000, including all layers.
Example:
 - In a single-layer job, 40 copies with 100 arranged jobs can be printed, which makes 4000 prints possible.
 - In a two-layer composite job, 20 copies with 100 arranged jobs can be printed, which makes 2000 prints possible.

Move a copied job individually

1 Select the number of copies to be made using [Copy] on the [Image Edit] tab.

2 Select a job to be moved in the preview.

3 Select [Each move].

4 Set [Scan] and [Feed] for [Move] on the [Image Edit] tab. Images can also be moved by dragging on the preview.

- Only the selected job is moved by the [Scan] and [Feed] size set here.



In these settings, you can also set the method of movement for multi-page jobs.

- [Block move]: Moves entire pages.
- [Each move]: Moves only selected pages.

● Set margin between jobs

Layout can be specified as [Space] or [Pitch].

Set margin between jobs

- 1 Select [Space] for [Layout] on the [Image Edit] tab.
- 2 Enter the necessary values for [Scan] and [Feed].
- 3 Select the optimization for the preview, then click the  icon.

- The job is rearranged using the new margin settings. Check the results on the preview.
- The margins set using the [Arrange] function will be overwritten by the operation in Step 3.

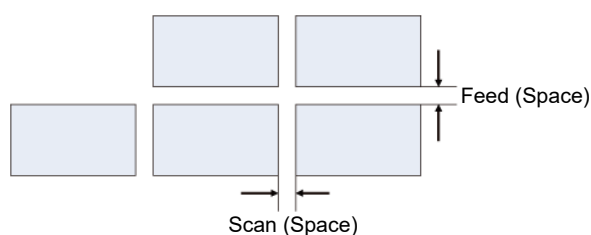

Set the distance from a job origin to the next job origin

- 1 Select [Pitch] for [Layout] on the [Image Edit] tab.
- 2 Enter the necessary values for [Scan] and [Feed].
- 3 Select the optimization for the preview, then click the  icon.

- The job is rearranged using the new margin settings. Check the results on the preview.

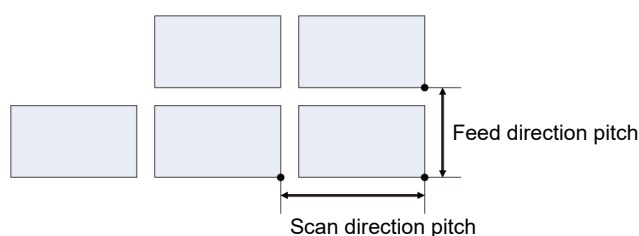

Important! [Pitch] is not displayed in the following cases.

- With arranged jobs
- With multi-page jobs

Position multiple pages side by side widthwise

- 1** Select [Each move] for [Copy] on the [Image Edit] tab.
- 2** Specify the required margins using [Layout].
- 3** Click the  icon.
 - The multiple pages are rearranged using the new margin settings. Check the results on the preview.



- When moving blocks, pages will be positioned vertically.

- **Set the printing pages**

Set the printing pages

- With multi-page jobs, [Printing range] items are displayed.

- 1** Set one of the following for [Printing page range] on the [Image Edit] tab.

[All]	:	Prints all of the pages for multi-page jobs.
[Page specification]	:	Prints those pages set.

Setting example:

To print pages 2 to 5	:	[2-5]
To print pages 2, 4 and 6	:	[2,4,6]
To print pages 2 to 5 and pages 8 and 11	:	[2-5,8,11]

● Set form-feeding



- The [FF(Form-feed)] item appears in the following cases:
 - When the job is a multi-page job
 - When the printer is not a flatbed printer
- This setting is available when [Copy] is set to [Block move] on the [Image Edit] tab.

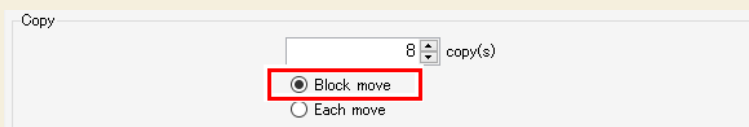

1 On the [Image Edit] tab, select one of the following options for [FF (Form-feed)].

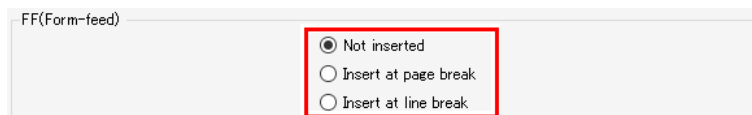

- [Not inserted] : Sends form-feed code at the end.
 [Insert at page break] : Sends form-feed code for each page.
 [Insert at line break] : Sends form-feed code for each line.

□ Layout image of 8 copies of a 4-page job

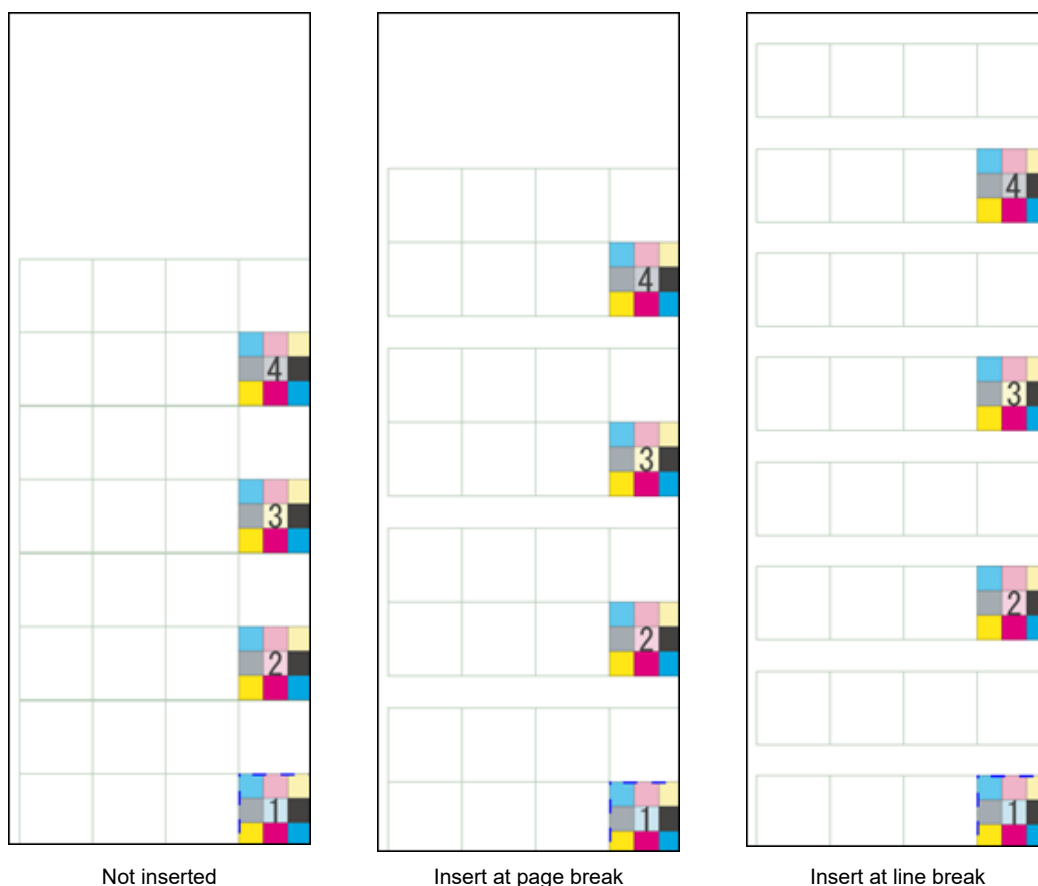

When [Cut after Print] is selected on the [Print Condition] screen, media is cut on the basis of form-feed code.

● Set the print area (with flatbed printers)



- Registering a valid print area provides a guide when positioning images. It also prevents printing outside the range of the media.

1 Enter the name of the new print area template to be set in the text input box for [Print Area] on the [Image Edit] tab.

2 Click the  icon.

- The new template will be registered.

3 Click [Setup].

- The [Print Area] dialog appears.

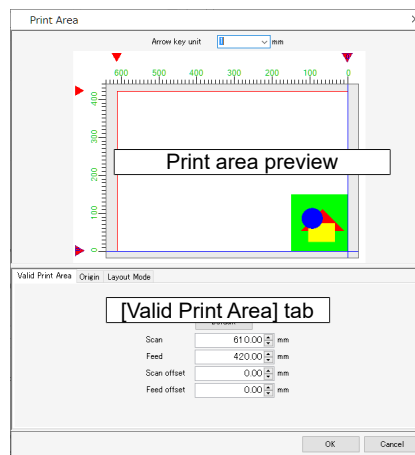

- Print area preview
The valid print area set on the [Valid Print Area] tab is indicated by a red rectangle.
- [Valid Print Area] tab

4 Set the following items.

- [Default] : Sets the valid print area to the maximum size and sets the origin position at the default origin position for the printer.
- [Scan] : Enter the width of the valid print area.
- [Feed] : Enter the feed for the valid print area.
- [Scan Offset] : Enter the offset distance from the printer origin in the width direction.
- [Feed Offset] : Enter the offset distance from the printer origin in the feed direction.

● Set register marks

Important! • Multi-page jobs cannot be added register mark.

1 [Register Mark] on the [Image Edit] tab is used to set the register marks added to jobs. Register marks are used to detect the cutting positions. Set the mark shape to suit the settings for the printer and cutting plotter.

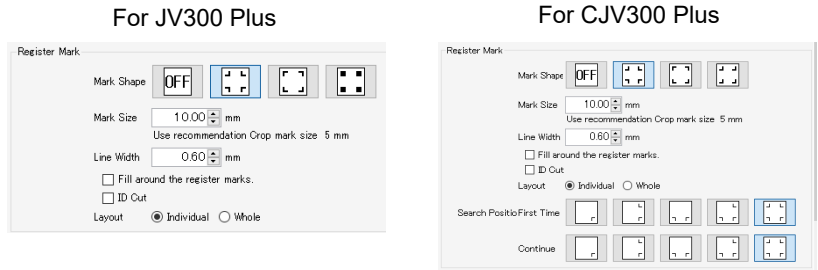

• [Mark Shape]

The following mark shapes can be selected. Select [OFF] if you do not wish to add register marks.



Zero margin register marks

Important! • This function can be used with the following printers:
CJV300, CV150, UCJV300, CJV300 Plus, CJV330, UCJV330

Using zero margin register marks allows the amount of media used in printing & cutting to be reduced compared to the Type 1 or Type 2 marks. Zero margin register marks can be set as follows.

1 Set the following conditions on the [General Print] screen.

- (1) Set [Copy] to a number greater than one.
- (2) Select [Block move] for the copy move method.

2 Select [Type 1] or [Type 2] for the register mark shape.

3 Select [Individual] for the register mark position. [Zero margin register mark] is now available for selection.

4 Select [Zero margin register mark] for the register mark shape.

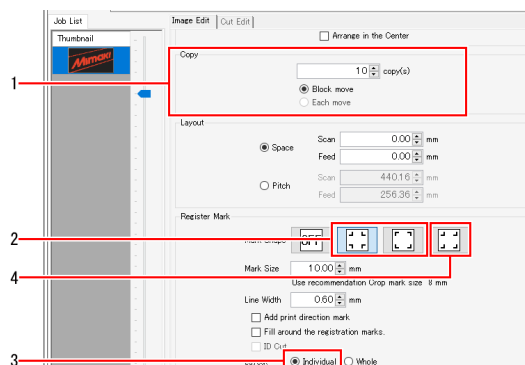

Square register marks

These cannot be used with printing and cutting machines.

- **[Size], [Line Width]**

The register mark size can be altered. [Use recommendation Crop mark size] indicates the recommended size to ensure detection using Mimaki printers and cutting plotters. Enter a value greater than this.



- The value for [Use recommendation Crop mark size] will vary depending on the job size.

- **Add print direction mark**

This adds a ▼ symbol when the register mark is printed. Adding this mark ensures that printed media is fed into the printer in the correct direction when working with jobs that make it difficult to identify the direction.

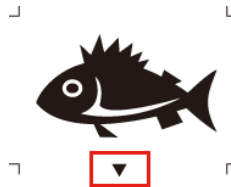

- This function can be used with the following printers: CJV300, CV150, UCJV300, CJV300 Plus, CJV330, UCJV330



The print direction mark function cannot be used in the following cases.

- When zero margin register mark is selected for [Shape] in [Register Mark]
- When an intermediate register mark is selected for [Shape] in [Register Mark]
- When the separation between register marks is less than 20 mm
- When the ID cut function is enabled
- With arranged jobs



- The print direction mark function cannot be registered as a favorite.
- When a job is rotated, the position of the print direction marks is moved to match the rotation.
- The size of the print direction marks does not change even when the register mark size or scale is changed.

- **[Fill around the register marks]**

The areas around the register marks can be filled in using red. This enables the register marks to be detected if they cannot be correctly detected on media whose background color is not white. It is also effective for ID cutting.

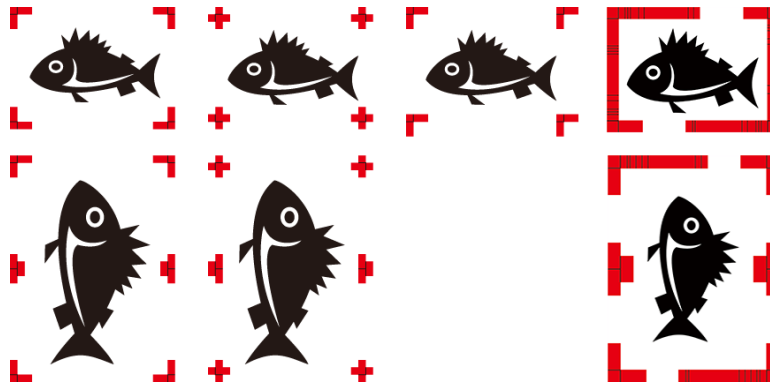

- If using a model equipped with white ink, set the [Fill color] to "White" in the [Color Settings] screen.
If registration marks cannot be recognized even when filled with red, specify white ink.
It also applies to ID cutting.

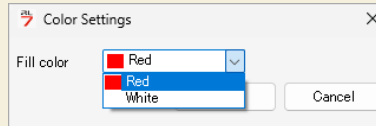

- [Layout]

This allows you to select whether register marks are added to each individual job or to the overall layout on which multiple jobs are positioned.

[Individual] : Adds register marks for each job. This increases the time taken for reading in, as the register marks have to be detected for each job when cutting, but it minimizes any offset between printing and cutting.

If [Individual] is selected and register marks are set to be printed for print & cut jobs, a screen appears for setting the register mark detection positions.

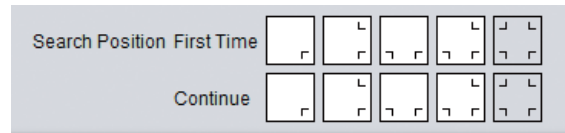

- Increasing the number of register marks to be read in increases the cutting position accuracy, but also increases the time taken.
- The register mark detection positions can be changed between the first time and subsequent times.



The following functions will not be available for use if [Individual] is selected for the register mark placement.

- [Tiling]
- [Step & Repeat]



Note that a register mark detection error will occur if [Individual] is selected for the register mark placement and the register marks are positioned as follows.

- When multiple copies are set and the number of jobs for the last row is smaller than the number of jobs for the first row

[Whole] : Adds register marks for the overall layout of multiple jobs. This reduces the time taken for reading in compared to [Individual], as there are fewer register marks to be detected, but it increases the offset between printing and cutting.

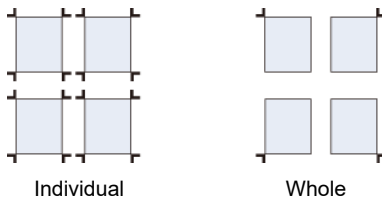

Individual

Whole



The following functions will not be available for use if [Whole] is selected for the register mark placement.

- [Tiling]
- [Step & Repeat]
- [Crop]



RasterLink7 cannot be used with the register mark detection function of Mimaki cutting plotters with the exception of print&cut machine or ID cutting.

- When cutting with a Mimaki cutting plotter after printing, add the register marks using FineCut.

- **[Intermediate Register Marks]**

(Important!)

- This function can be used with the following printers:
CJV300, CV150, UCJV300, CJV300 Plus, CJV330, UCJV330

Intermediate register marks can be added when [Whole] is selected for the register mark placement.

Adding intermediate register marks ensures more accurate cutting with long-length jobs.

[Direction] : Sets the orientation of intermediate register marks.

[Count] : Sets the number of intermediate register marks. (The number can be set in a range from 2 to 10.)

(Important!)

The following points should be noted when setting intermediate register marks.

- Set the count to ensure that the register marks are spaced at least 50 mm apart.
- Set the offset to at least the size of the register marks.

- **[Offset]**

This allows an offset to be set between the register marks and the jobs.

- **Print cut lines**

1 Select the [Cut line] check box for [Cut line] on the [Image Edit] tab.

2 Click [Setup].

- The [Cut line settings] dialog appears.

3 Set the following items.

[Line Width] : Set in a range between 0.3 point and 30 points (in 0.1 point increments).

[Line Color] : Set the line color.

[Interval Color] : Set the color between lines.

[Dashed line] : Selecting the check box changes lines to dashed lines.

[Dashed line style] : Set the length of dashes and intervals between dashes in the dashed lines.



- Selecting the [Cut line] check box displays the output size as the size including the cut lines.

Important! Cut lines cannot be printed in the following cases.

- When [Step & Repeat] is set
- When [Shape] is specified as other than [OFF] in [Register Mark]
- For jobs with register marks output using RasterLink from FineCut

● Set Fotoba cut marks

1 Select the [Add fotoba cut mark] check box for [Fotoba cut mark] on the [Image Edit] tab.

2 Click [Detail].

- The [Fotoba cut mark print settings] dialog appears.

3 Set the following items.

[Mark Shape] : Sets the marks between jobs. Select [] if you do not wish to print vertical marks between jobs, select [] if you wish to print vertical marks between jobs, and select [] if you wish to use double lines for the vertical marks.

[Horizontal mark width] : Select the width of the marks in the scan direction.

[Line Width] : Set in a range from 1.0 mm to 3.0 mm.

[Line Spacing] : Set the spacing between the double lines in a range from 1.0 mm to 3.0 mm.

[Margin] : Set the margins between jobs and marks.

[Between Jobs] : The margins between jobs can be set if [] (do not print vertical marks between jobs) is selected for [Shape]. Set in a range from 1.0 mm to 1,000.0 mm.

[Layout] : Select the job placement position.

[Offset] : This allows the distance to the mark from the right-hand edge to be set when [Right] is selected, and the distance to the mark from the left-hand edge to be set when [Left] is selected.

Important! Fotoba cut marks cannot be added in the following cases.

- With Print & Cut jobs
- With jobs using twin-roll printing
- With jobs using step & repeat printing
- Special plate job
- With jobs for which any of the following are set on the [General Print] screen (Register mark shape is not set to [OFF], [Lock the trimming position] is selected, or [Cut line] is selected)
- With jobs for which [Print Corner Mark] or [Cut line] is selected from the [Tiling] screen
- With auto execution



- [Target size] displays the size (calculated size) after cutting using a Fotoba Series.
- This can be used in conjunction with the copy, arrangement, and tiling functions.

● Set the XY slitter

Important! • This function can be used with the following printers:
JV330, CJV330, UCJV330

Using an XY slitter enables slitting to be performed in-line. Selecting the [XY Slitter Edit] check box and setting the corresponding items prints marks and reference lines for X slitting.

For more information on how to use the printer and RasterLink7, refer to "Using the XY Slitter" in the "330 Series Operation Manual".

1 Select the number of copies to be made using [Copy] on the [Image Edit] tab.

- Copying is not necessary when slitting variable print jobs.

2 Select the [XY Slitter Edit] check box on the [Image Edit] tab.

XY Slitter

XY Slitter Edit

3 Select the slitting method.





Slit at the same time as printing
 Slit afterwards

[Slit at the same time as printing]

- Select when printing using the printer and slitting straightaway using the finisher.
- The marks are printed on the right edge of the media.
- The width of the area available for printing will be reduced by 30 mm to allow the marks to be printed.

[Slit afterwards]

- Select when printing using the printer and slitting afterwards.
- The marks are printed on the right and left edges of the media.
- The width of the area available for printing will be reduced by 60 mm to allow the marks to be printed.
- The following five types of mark are available, the spacing of which is determined automatically depending on the setting. (Size cannot be altered)

	Mark 1	Scan: 30 mm Feed: 1.5 mm
	Mark 2	Scan: 30 mm Feed: 6 mm
	Mark 3	Scan: 10 mm Feed: 10 mm
	Mark 4	Scan: 20 mm Feed: 1.5mm
	Mark 5	Scan: 20 mm Feed: 6 mm



It cannot be used in combination with the following functions.

- Auto Cut on the quality screen
- Auto Cut on the Cut Edit tab
- Rearrangement
- Copy block move
- Fill around the registration marks
- Fotoba cut mark
- Cut Line
- Centering
- Color pattern
- Left/right margin
- Step & Repeat jobs
- Outer Frame Cut
- Print & Cut jobs
 - Can be used only when [Slit afterwards] is selected.
 - ID Cutting can also be specified. However, Print & Cut jobs from FineCut cannot be used together.
- Register mark
 - Can be used only when [Slit afterwards] is selected.
 - Zero margin register marks cannot be used when the [XY Slitter Edit] check box is checked.
 - Individual registration marks can be used only when one copy is specified. When two or more copies are specified, only whole register marks can be used.
- Pull-back print (UCJV330)

Important!

When using the ID cut and XY slitter in combination, make sure that the ID and XY slitter marks do not overlap the same line. Depending on the top and bottom print bleed settings, marks will be printed on the same line and a detection error will occur when detecting the register mark of the ID cut. Be careful not to overlap the marks.

- Example 1 : When the mark is printed on the same line

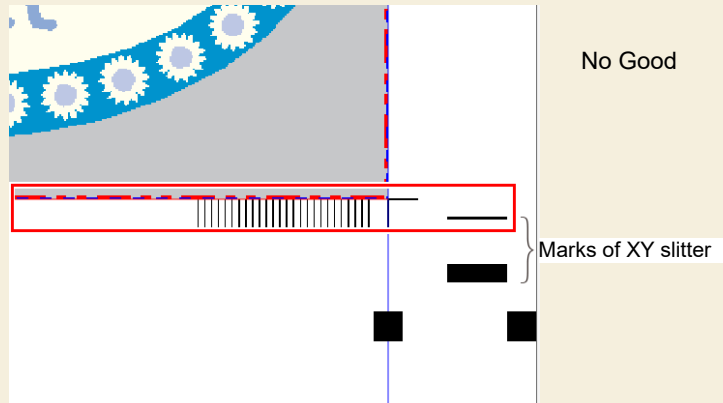

- Example 2 : When the mark is not printed on the same line

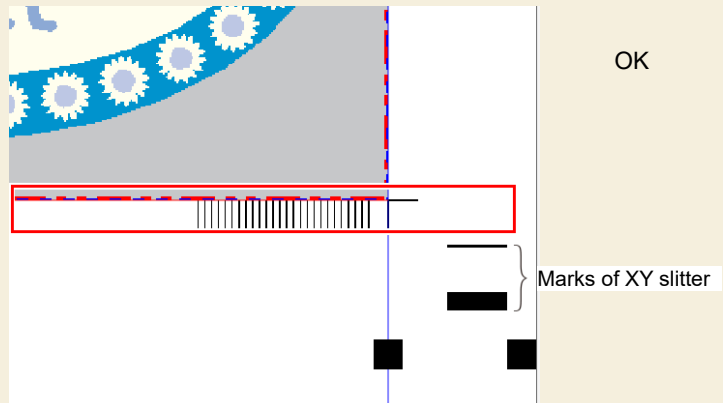

4 Select the Y direction slitting method using [Y Slit].

- The following three slitting methods are available:
[Normal], [Line Space], [None]

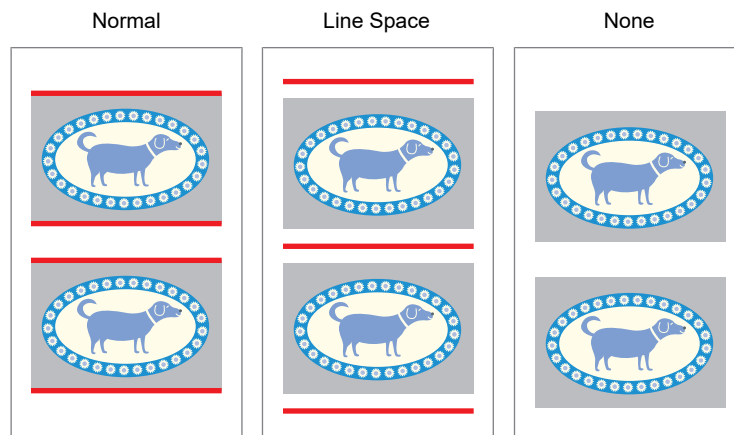
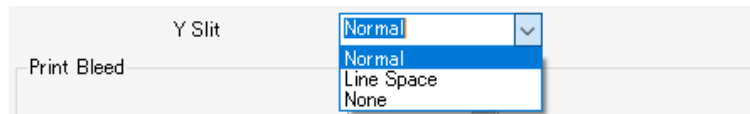

Y direction: Red lines will be slit

Item	[Normal]	[Line Space]	[None]
Y slit position	Top and bottom edges of image	Margin (feed)/2 ^{*1}	None
Size	Feed: 297 mm or more Scan: 210 mm or more	Feed: 297 mm or more Scan: 210 mm or more	Feed: 297 mm or more Scan: 210 mm or more
Margin (feed)	62 mm or more	0 mm or more	0 mm or more

*1: If the margin is 10 mm, slitting will be performed leaving a margin of 5 mm above and below the image. All image data will be slit using the same size.

5 Set the margins using [Print Bleed].

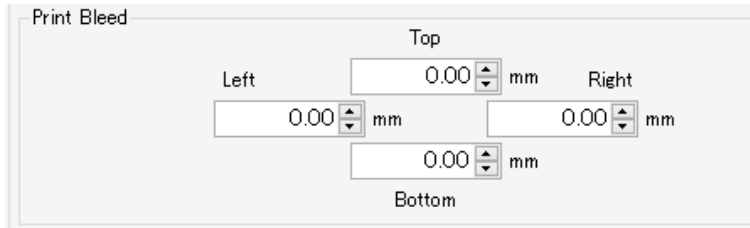

- Positive value : Image data will be slit on the inside according to the size specified. (No border)
- Negative value : Image data will be slit on the outside according to the size specified. (Margins added)

Positive value



Negative value

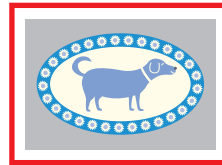

X/Y direction: Red lines will be slit

Item	[Normal]	[Line Space]	[None]
[Print Bleed]	Top/bottom/left/right	Left/right	Left/right

6 When using white ink to print the marks and X cutter reference lines, select the [XY slitter marks are printed in white] check box.

- This is displayed when white ink has been set in the printer.
- This is used for slitting transparent media.



7 Set the quantity of image data to be arranged in the media width direction using [Width Copy Count].

- Up to two copies can be specified. (Four X cutters are required when two copies are specified.)



8 Set the scan direction margin between mark and image using [Mark Offset].



- Click [Automatic mark offset setting] to automatically set the offset and position the image data in the center of the media.

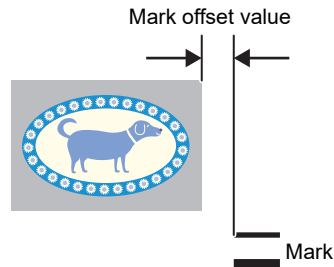

Important! Precautions regarding Width Copy Count and Mark Offset

- If you set [Automatic mark offset setting] while [Slit afterwards] is selected, a mark will be added to the left edge of the media. If you increase the number of copies in [Width Copy Count], these marks will exceed the media, so the number of copies cannot be increased as is. If you want to increase the number of copies, enter 0 in [Mark Offset] and then increase the number of copies in [Width Copy Count].

9 To print reference lines for setting the X cutter, click [Print X-Cutter Reference line].

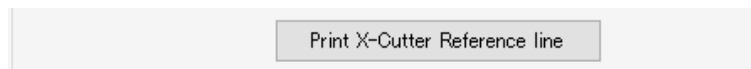

- The [Print X-Cutter Reference line] dialog appears.
- Clicking [OK] prints the X cutter reference lines.

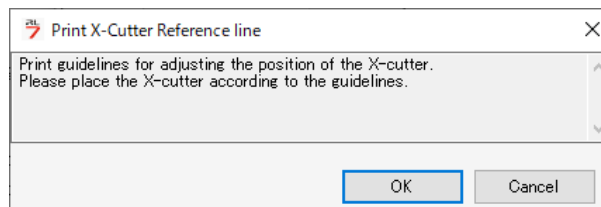

- One copy in the scan direction: Two X reference lines are printed.
- Two copies in the scan direction: Four X reference lines are printed.
- The reference line feed direction size is 545 mm.

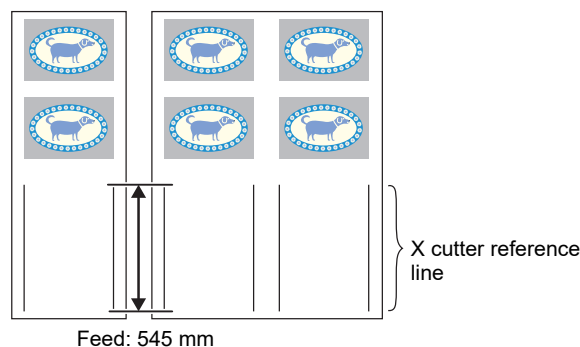

- Set the X cutter blade at the position corresponding to the printed X cutter reference line, as instructed on the main unit operation panel.

10 Check [X-Cutter Place].

X-Cutter Place

Out Line Right mm

 Left mm

 Right Margin mm

When adjusting the X-cutter manually, Please add the value of the right margin to the value of the cut line.

[Cut Line] [Right] : Displays the distance of the image right-hand edge from the right-hand edge of the media.

[Left] : Displays the distance of the image left-hand edge from the right-hand edge of the media.

[Right Margin] : The right margin size set for the printer is displayed here.

 : When the width copy count is set to 2, the left/right buttons can be used to select the column and check the X cutter position.

- Calculate the X cutter position by adding the right margin size to the X cutter position displayed on the screen.



XY Slitter Edit can be used in conjunction with the following functions and jobs:

- Jobs with multiple copies set on the [General Print] window and [Each move] selected
- With composite jobs
- Variable print jobs
- Jobs cropped on the [Crop] window
- Jobs with layout margins specified
- Jobs with move set ([Arrange in the Center] not selected)
- Jobs with a printed information label added

● Set information labels

1 Select the [Add label] check box for [Information label] on the [Image Edit] tab.

2 Select the check box for the information to be added.



- If the "Printed Date" checkbox is checked, the RIP will be executed even if "Print Only" is selected for "Execution".

● Print

1 Click the  icon in the preview.

- Ripping/printing starts.



- The processing used for execution can be set in [Option] - [Job Control] ( P. 240).

2.2.8 Tiling

Divides large jobs before printing.

Tiling - Functions



- In RasterLink7, items to be processed, such as signs, are referred to as "work", and divided work is referred to as "tiles".

[Tiling] allows the following operations.

- Enlarge or reduce a tiling job
- Rotate a tiling job
- Reverse a tiling job
- Set the output range for the work
- Divide the work into tiles
- Set overlap
- Print tile numbers
- Print cut lines
- Set the tile printing order
- Reverse tiles in even columns
- Position tiles in desired locations
- Move specified tiles



- Work can be divided into up to 100 tiles.

● Conditions

[Tiling] cannot be set for jobs with the following settings.

- [Arrange]
- [Step & Repeat]
- [Composite]
- [Print & Cut]
- When register marks are set in [General Print]
- When two or more copies are set in [General Print]
- Multi-page jobs
- [Variable Edit]
- [Edge Optimizer]
- [Lock the trimming position] is selected

Tiling - Screen Layout

- [Tiling] screen

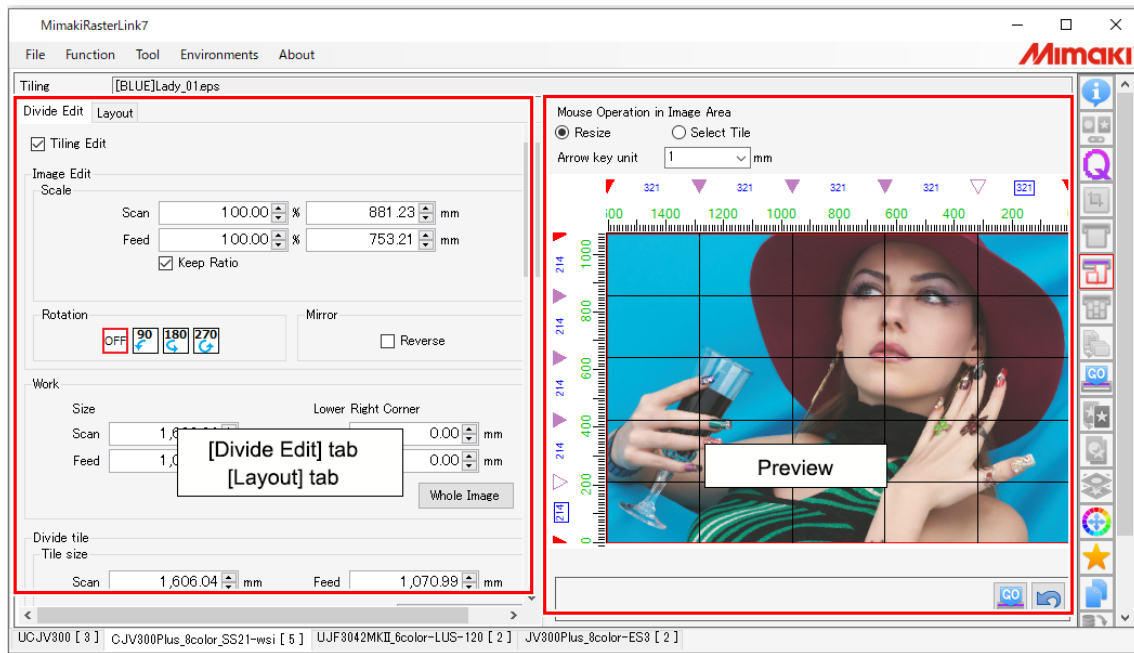

● [Divide Edit] tab

1. [Tiling Edit]

Selects whether or not to set [Tiling].

2. [Scale]

Enlarges and reduces jobs.

3. [Rotation]

Rotates the job.

4. [Mirror]

Reverses the job.

5. [Work]

Sets the output range for the work.

6. [Divide tile]

Divides the work into tiles.

7. [Overlap]

Sets the overlap for adjacent tiles.

8. [Option]

Sets the numbers and outer frames printed for tiles.

9. [Print Order]

Selects the tiles to be printed and sets the tile printing order.

10. [Information Label]

Selects information to be printed.

● [Layout] tab

The screenshot shows the [Layout] tab with four numbered sections:

- Layout:** Includes options for "Reverse Even-numbered Column" (unchecked), "Free Location" (checked), "Alignment Mode" (Nest), "Scan margin" (0.000 inch), "Feed margin" (0.000 inch), and "Arrange in the Center" (unchecked).
- Position:** Includes "Scan" (0.000 inch) and "Feed" (0.000 inch) fields.
- Fotoba cut mark:** Includes "Add Fotoba cut mark" (unchecked), "Target size" (Scan: 50.980 inch, Feed: 33.681 inch), and a "Detail..." button.
- XY Slitter:** Includes "XY Slitter Edit" (unchecked), "Slit at the same time as printing" (selected), "Slit afterwards" (unchecked), "Y Slit" (Normal), "Print Bleed" (Left: 0.000 inch, Right: 0.000 inch, Bottom: 0.000 inch), "XY slitter marks are printed in white" (unchecked), "Width Copy Count" (1 copy(s)), "Mark Offset" (0.000 inch), "Automatic mark offset setting" (button), "Print X-Cutter Reference line" (button), "X-Cutter Place" (Right: 0.00 inch, Cut Line: Left: 650.45 inch), "Right Margin" (0.591 inch), and a page indicator "1 / 1".

When adjusting the X-cutter manually, please add the value of the right margin to the value of the cut line.

1. [Placement]

Sets the layout mode when printing tiles.

2. [Position]

Adjust the position of specified tiles.

3. [Fotoba cut mark]

Selecting the check box prints cut marks used with the Fotoba Series (high-speed finishing cutter machine). For more information on settings, refer to ["Set Fotoba cut marks"\(P. 99\)](#).

4. [XY Slitter]

Selecting the check box prints the XY slitter marks and reference lines. For more information on installation, refer to ["Set the XY slitter"\(P. 100\)](#).

Tiling - Operations

● Start tiling setting

- 1 Select the [Tiling Edit] check box on the [Divide Edit] tab.
 - This allows the various [Tiling] function settings to be edited.

● Enlarge or reduce a tiling job

- 1 Select the [Valid] check box in [Scale].
- 2 Sets [Scan] and [Feed] for the job to be printed.
 - [Scan] and [Feed] can be set as ratios (%) or size.
 - If the [Keep aspect ratio] check box is selected, jobs can be enlarged or reduced while retaining the aspect ratio of the original image.

● Rotate a tiling job

- 1 Select the angle for counter-clockwise rotation in [Rotation].

● Reverse a tiling job

- 1 Select the [Reverse] check box in [Mirror].

● Set the output range for the work

- 1 Set the [Scan] and [Feed] for [Size] in [Work].
- 2 Set the [Scan] and [Feed] for [Lower Right Corner].
 - The lower right reference point of the work is updated.
 - The range of the output work is indicated by red lines in the preview.



- Clicking [Whole Image] resets the settings.

● Divide the work into tiles

Divide by setting tile size

- 1 Set the [Scan] and [Feed] for [Tile size] in [Divide tile].
- 2 Click [Apply to All Tiles].
 - The work is divided based on the lower right reference point.

Divide by setting number of tiles

1 Set the value for [Width] for [Tile quantity] in [Divide tile].

2 Set the value for [Feed] for [Tile quantity].

- The work is divided equally into identical size tiles.

Setting tile size individually

Use the [Right], [Left], [Top], and [Bottom] buttons to select the required tile and specify the size. The size of a selected tile is displayed in the preview in boxes as shown below.

Clicking a ▼ symbol selects it (changing to ▾) and allows fine adjustment using the cursor keys.

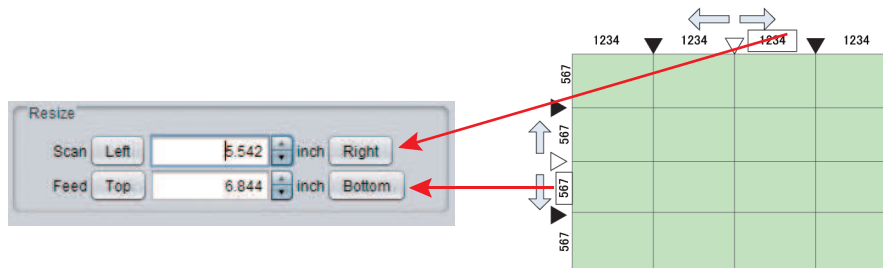
**Important!**

- Set each tile to a size at least 25.4 mm per side. Tiles less than 25.4 mm in size may be created at the top edge or left edge of the work. In such cases, increase the size of the tiles adjoining the top edge or left edge using [Resize].
- If tiles measuring 25.4 mm or less are present, a warning message will appear when printing or switching between screens, and processing will be aborted.

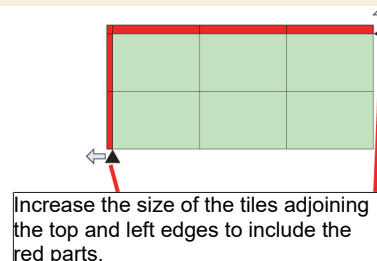
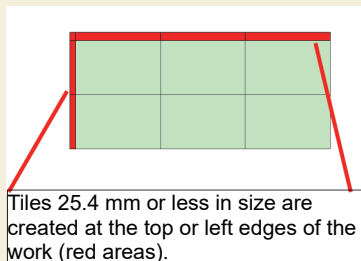

● Set overlap

When producing signs, gaps may result when tiled images are pasted unmodified. Overlaps can therefore be set for areas between adjacent tiles to prevent this.

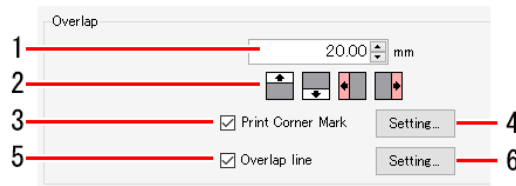

1 Enter the overlap length in the numerical input box (1 in the figure above) in [Overlap].

2 Click the required overlap position selection icons (top, bottom, left, and right icons, 2 in the figure above).

- The clicked icons change color.
- The following figure shows an example with the work divided into three widthwise. The overlap will be set as shown below (overlap indicated by shaded areas) if the "Left" and "Right" overlap position selection icons are clicked.

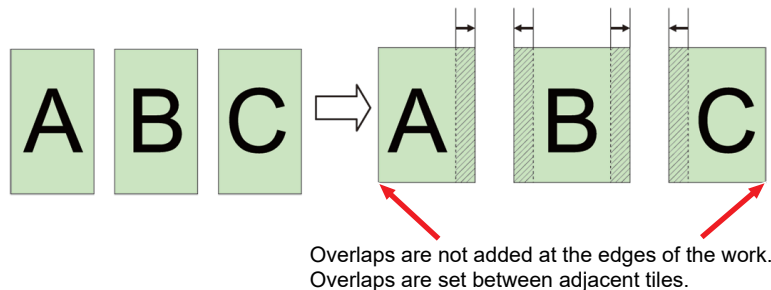

3 If you wish to print marks for aligning the tiles after printing, select the [Print Corner Mark] check box (3 in the figure above).

4 The [Corner mark settings] dialog appears when the [Setup] button (4 in the figure above) is clicked.

[Corner mark settings] dialog

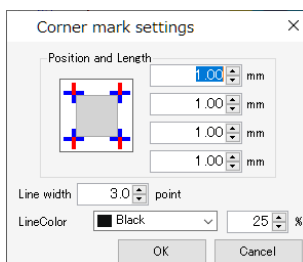

[Position and Length] : Sets the line length (0 mm to 100 mm) for the + marks. (The locations of the lines in the + marks currently being edited in the dialog for which the length is being changed are indicated in red.)

[Line Width] : Sets the line width (0.3 pt to 30 pt) for the + marks. This can be set in 0.1 pt increments.

[Color] : Sets the line color and density for the + marks.

- Clicking [OK] applies the settings.

5 If you wish to print lines at the boundaries between the tile body and the overlap, select the [Overlap line] check box (5 in the figure above).

6 The [Overlap line settings] dialog appears when [Setup] (6 in the figure above) is clicked.

[Overlap line settings] dialog

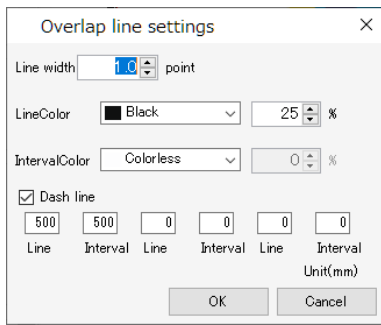

- [Line Width] : Sets the line width. This can be set in 0.1 pt increments.
- [Line Color] : Sets the line color.
- [Interval Color] : Sets the color between lines.
- [Dashed line] : Selecting the check box changes lines to dashed lines. The length of dashes and interval between dashes can be set in 1 mm or 0.1 inch increments.

- Clicking [OK] applies the settings.



Corner marks and overlap lines will be printed on the overlaps.

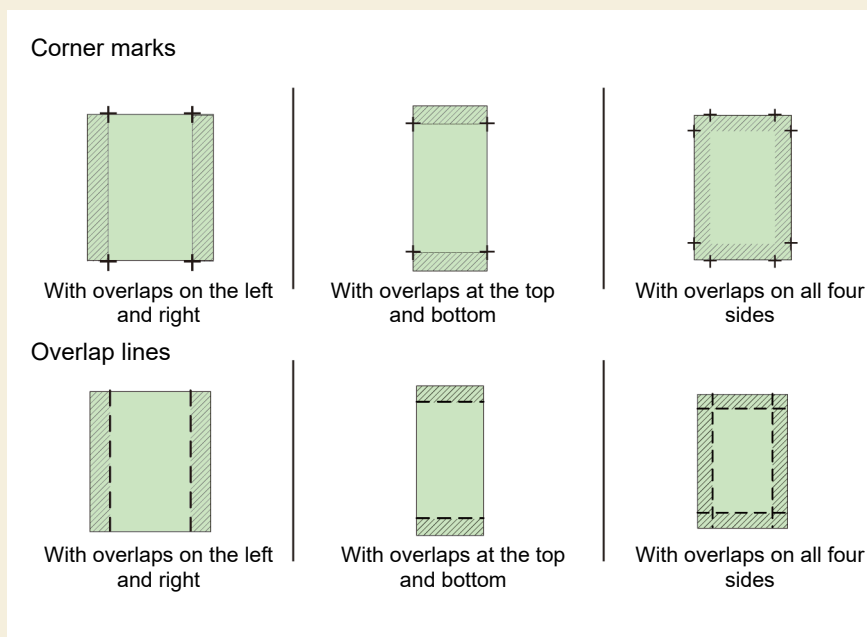

● Print tile numbers

Enabling this setting prints the tile numbers to make it easy to determine the position of each printed tile.

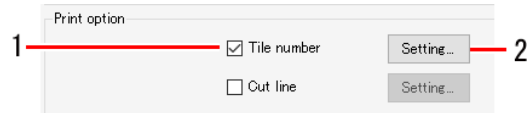

1 Select the [Tile number] check box in [Option].

2 The [Tile number settings] dialog appears when [Setup] is clicked.

[Tile number settings] dialog

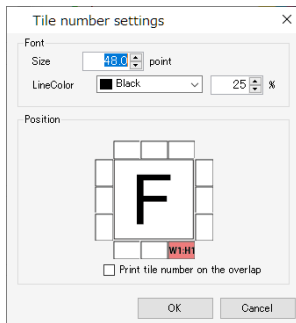

- [Size] : Sets the font size for the tile numbers to be printed. (10 to 120 points)
- [Line Color] : Sets the color for the tile numbers to be printed.
- [Position] : Sets the position at which tile numbers will be printed.
- [Print tile number on the overlap] : Selecting the check box prints tile numbers on the overlaps.

- Clicking [OK] applies the settings.



- The tile numbers are indicated with W for the scan direction and H for the feed direction, with the tile at the bottom right (print origin) numbered (1,1).

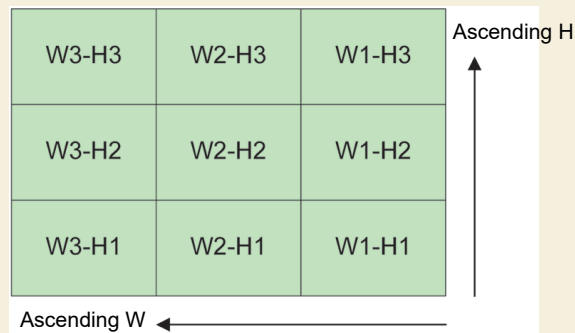

● **Print cut lines**

Enabling this setting prints cut lines around the tiles. This can be used as a guide for cutting when tiles have white areas.

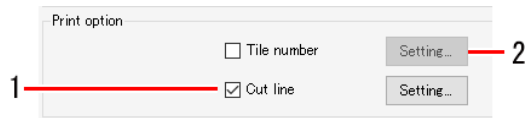

1 Select the [Cut line] check box in [Option].

2 The [Cut line settings] dialog appears when the [Setup] button is clicked.

[Cut line settings] dialog

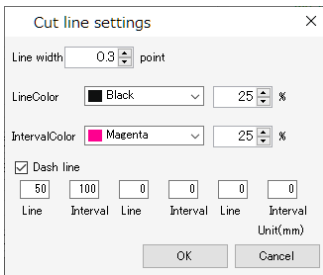

- [Line Width] : Sets the line width. This can be set in 0.1 pt increments.
- [Line Color] : Sets the line color.
- [Interval Color] : Sets the color between lines.
- [Dashed line] : Selecting the check box changes lines to dashed lines. The length of dashes and interval between dashes can be set in 1 mm or 0.1 inch increments.

- Clicking [OK] applies the settings.



- Cut lines are printed on the perimeter of the tiles including the overlaps.

● **Set the tile printing order**

Print all tiles

1 Click the [Z] icon for [All tiles] in [Print Order].

Example: Dividing the work into 9 tiles

Icon																																								
Print order	<table border="1"> <tr><td>9</td><td>8</td><td>7</td></tr> <tr><td>6</td><td>5</td><td>4</td></tr> <tr><td>3</td><td>2</td><td>1</td></tr> </table>	9	8	7	6	5	4	3	2	1	<table border="1"> <tr><td>7</td><td>8</td><td>9</td></tr> <tr><td>4</td><td>5</td><td>6</td></tr> <tr><td>1</td><td>2</td><td>3</td></tr> </table>	7	8	9	4	5	6	1	2	3	<table border="1"> <tr><td>3</td><td>2</td><td>1</td></tr> <tr><td>6</td><td>5</td><td>4</td></tr> <tr><td>9</td><td>8</td><td>7</td></tr> </table>	3	2	1	6	5	4	9	8	7	<table border="1"> <tr><td>1</td><td>2</td><td>3</td></tr> <tr><td>4</td><td>5</td><td>6</td></tr> <tr><td>7</td><td>8</td><td>9</td></tr> </table>	1	2	3	4	5	6	7	8	9
9	8	7																																						
6	5	4																																						
3	2	1																																						
7	8	9																																						
4	5	6																																						
1	2	3																																						
3	2	1																																						
6	5	4																																						
9	8	7																																						
1	2	3																																						
4	5	6																																						
7	8	9																																						

Print specified tiles

1 Select [Selected tiles in [Print Order]].

- Numbers are displayed on the tiles in the preview indicating the print order.

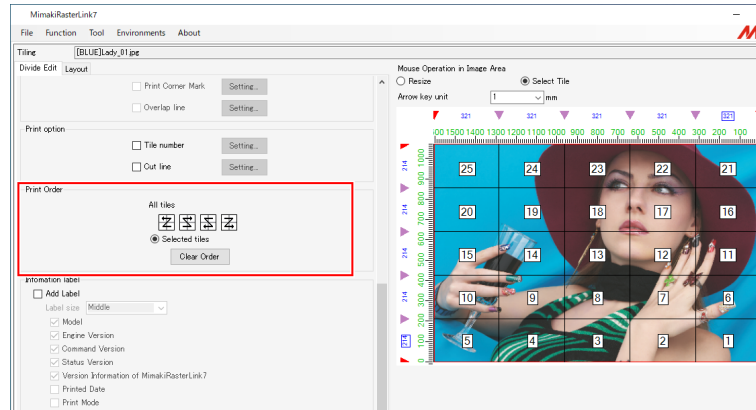

2 Click [Clear Order].

- This removes the numbers from the preview.

3 Click the tiles to be printed in the preview.

- Numbers are displayed on the tiles clicked indicating the print order.
- The print order is determined by the order in which the tiles are clicked.
- Clicking [Clear Order] resets the print order specified.

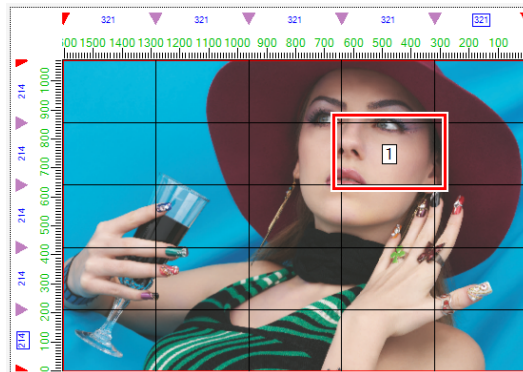

● Reverse tiles in even columns

Slight color differences may occur between the left and right sides of the printer due to uneven heater temperature.

This may result in the border sections of adjacent tiles standing out when the tiles are pasted together. In such cases, print by reversing the tiles in even columns.

1 Select the [Reverse Even-numbered Column] check box in [Placement] on the [Layout] tab.

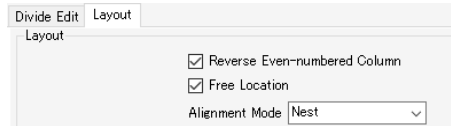

- [Reverse Even-numbered Column] unselected: All tiles are printed with the same orientation.

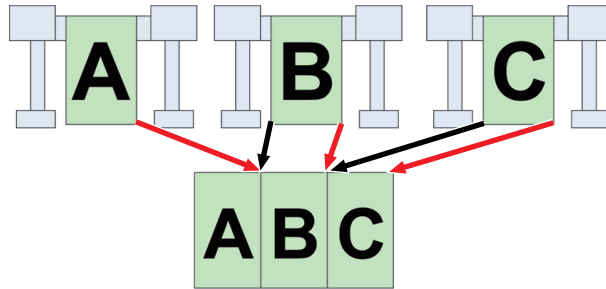

- [Reverse Even-numbered Column] selected: Tiles in even-numbered columns (tile B in this example) are rotated by 180° before printing.

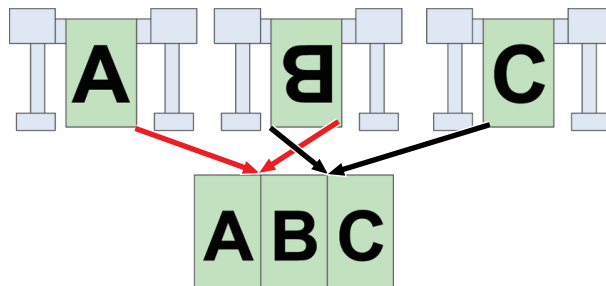

● Position in desired locations

1 Select the [Free Location] check box in [Placement] on the [Layout] tab.

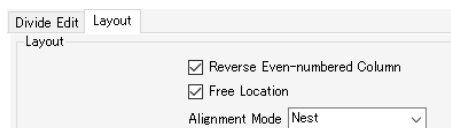

2 Select [Alignment Mode].

- [Nest]: Places tiles side by side widthwise.

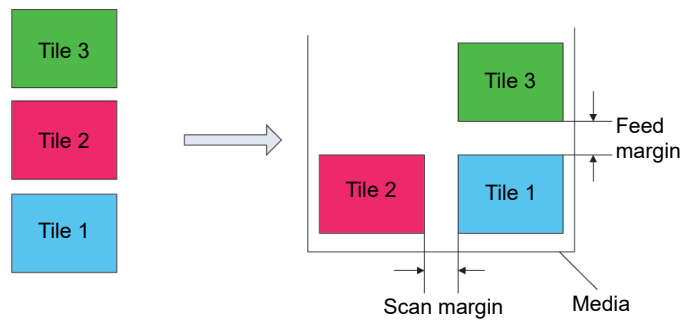

- [Sequential]: Places tiles side by side in the feed direction.

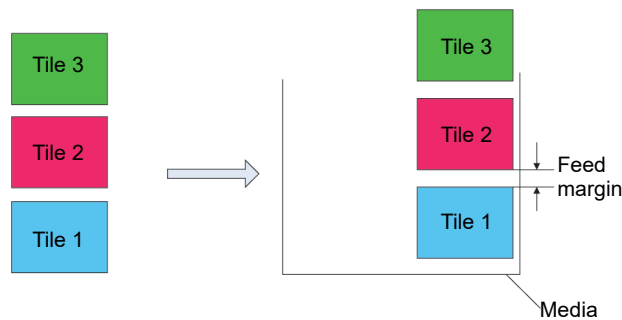

3 Set [Scan margin] and [Feed margin].

4 Click [Rearrange].



- Selecting the [Arrange in the Center] check box positions for all of the tiles in the center of the media.
- Tiles can be positioned as desired by dragging them on the preview.

● Move specified tiles

1 Select the tile to be moved in the preview.

2 Set the values for [Scan] and [Feed] in [Move] on the [Layout] tab.

- The tile is moved accordingly.

Position	
Scan	65.00 mm
Feed	180.00 mm

● Print

1 Click the icon in the preview.

- This starts ripping and printing using the same settings as the last time [Execute] was used. For more information on settings, refer to  "Execute"(P. 127).

2.2.9 Step & Repeat

Lays out image data with no gaps between them before printing.

Step & Repeat- Functions

[Step & Repeat] allows the following operations.

- Enlarge or reduce a step & repeat printing job
- Rotate a step & repeat printing job
- Reverse a step & repeat printing job
- Move an entire job
- Set the job layout and print size
- Set sticker printing (when using a roll-to-roll printer)

● Conditions

[Step & Repeat] cannot be set for jobs with the following settings.

- [Arrange]
- [Tiling]
- [Print & Cut]
- With multi-page jobs
- When two or more copies are set in [General Print]
- When register marks are set in [General Print]
- With composite jobs including special plate jobs created using [Special plate]
- With composite jobs including jobs for which the special color ink is set for [Ink after replacement] in [Mono Color]
- [Variable Edit]
- [Edge Optimizer]
- [Lock the trimming position] is selected

Step & Repeat - Screen Layout

● [Step & Repeat] screen

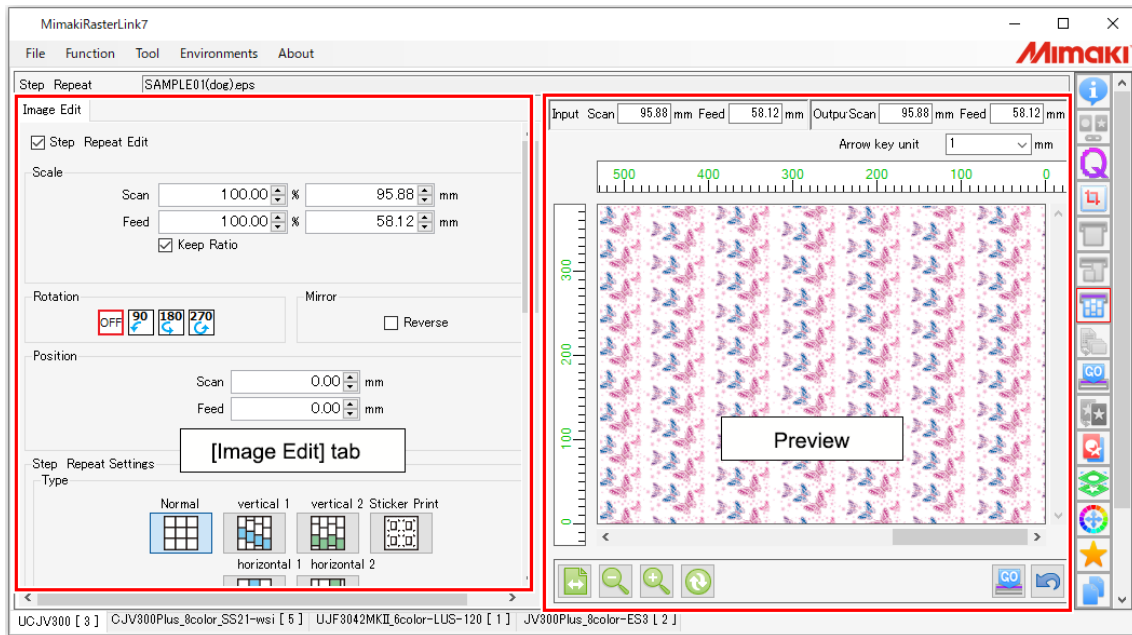

● [Image Edit] tab

1. [Step & Repeat]

Selects whether or not to use step & repeat printing.

2. [Scale]

Enlarges and reduces jobs.

3. [Rotation]

Rotates the job.

4. [Mirror]

Reverses the job.

5. [Position]

Moves the entire job positioned using [Step & Repeat].

6. [Type]

Sets the job layout.

7. [Offset]

Adjusts the job layout.

8. [Size]

Sets the size to be printed.

9. [Sticker Print] (When using a roll-to-roll printer)

Sets sticker printing.

10. [Margin]

Selects whether to remove the margins around the image.

11. [Information Label]

Selects information to be printed.

Step & Repeat- Operations

● Start step & repeat printing setting

- 1 Select the [Step & Repeat Edit] check box on the [Image Edit] tab.
 - This allows the various [Step & Repeat] screen settings to be edited.

● Enlarge or reduce a step & repeat printing job

- 1 Select the [Valid] check box in [Scale] on the [Image Edit] tab.
- 2 Sets [Scan] and [Feed] for the job to be printed.
 - If the [Keep aspect ratio] check box is selected, jobs can be enlarged or reduced while retaining the aspect ratio of the original image.

● Rotate a step & repeat printing job

- 1 Select the angle for counter-clockwise rotation in [Rotation] on the [Divide Edit] tab.

● Reverse a step & repeat printing job

- 1 Select the [Reverse] check box in [Mirror] on the [Image Edit] tab.

● Move an entire job

Set the origin position

- 1 Enter [Scan] and [Feed] for [Move] on the [Image Edit] tab.
 - The origin position of the entire job is changed by the [Scan] and [Feed] values set here.

Position in the center (widthwise)

- 1 Select the [Arrange in the Center] check box for [Move] on the [Image Edit] tab.
 - The entire job will be positioned in the center of the media (widthwise).

● Set the job layout

1 Select one of the [Type] icons on the [Image Edit] tab.

[Type] icon



[Normal]

: Arranges using uniform rows and columns.



[Vertical 1]

: Arranges by offsetting vertically.
An offset amount is added for each column.



[Vertical 2]

: Arranges by offsetting vertically.
Only even rows are offset.



[Horizontal 1]

: Arranges by offsetting horizontally.
An offset amount is added for each row.



[Horizontal 2]

: Arranges by offsetting horizontally.
Only even rows are offset.



[Sticker Print]

: Refer to "Set sticker printing (when using a roll-to-roll printer)" P. 126.

2 Set a desired value for [Offset].

- The offset for rows or columns is set as a fraction.
- The left-hand input box indicates the numerator, and the right-hand input box indicates the denominator.

Example: With offset set to 1/3

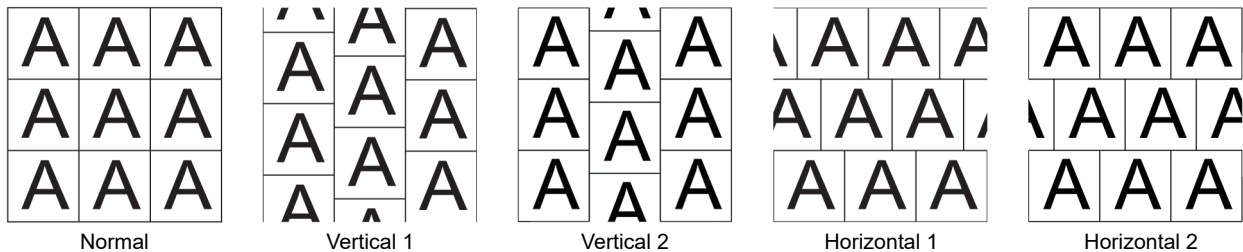

3 Set the size to be printed in [Size].

- **When specifying using length**

Set [Scan] and [Feed] (maximum 950,000 mm) in [Length].

- **When specifying by number**

Set [Scan] (number of columns) and [Feed] (number of rows) in [Number of Pieces].

The maximum value for number of feed pieces will be 950,000 mm divided by the scaled image feed size.

Important! Margins around original image

- The margins surrounding the original images will be deleted when arranging jobs.
- Even if margins were intentionally set when the original images were created, these will still be deleted.

Example: When the [Normal] icon is selected and the width is set to 2 and the height is set to 3 with [Number of Pieces]

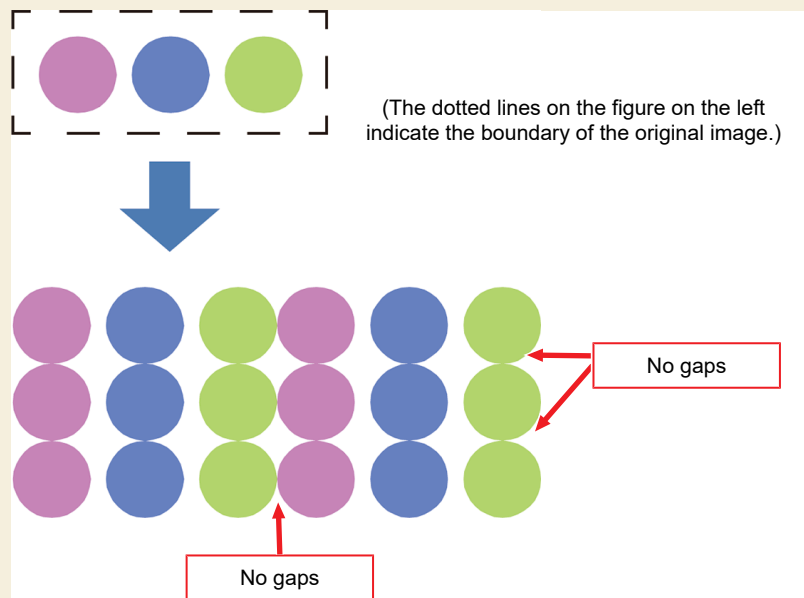

Important! Difference between preview and actual printing results

- The preview will differ from the actual printing results.
- The preview shows the margins not deleted.

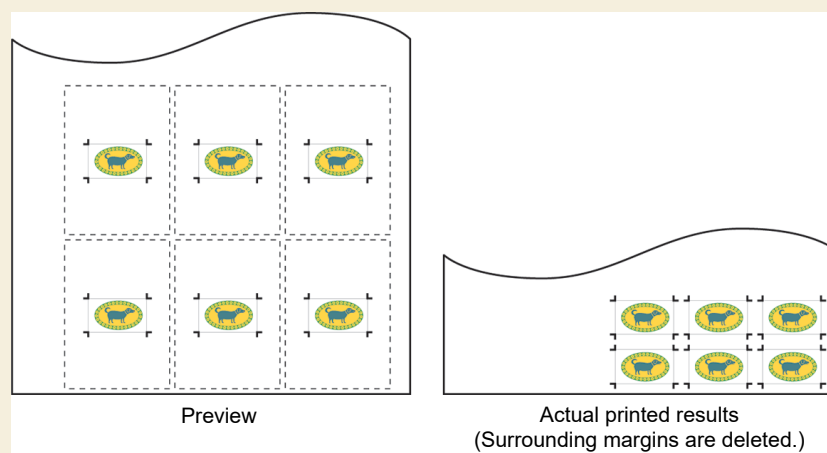

● Set sticker printing (when using a roll-to-roll printer)

Copies when placing cut jobs side by side.

1 Click the  icon for [Type] on the [Image Edit] tab.

2 Set the various items in [Sticker Print]

- [Total] : Sets the number of jobs.
 [Width direction] : Sets the number of jobs arranged in the width direction.
 [Margin] : Sets the interval between jobs.
 [Roller Margin] : Sets the margin on the right side of the media.

Important! • For information on the [Margin] and [Roller Margin] values, refer to the operation manual for the cutting plotter being used.

[Reference Line] : Prints a line forming the datum when cutting using a cutting plotter.



- Margins may be created around a job if the print data is imported to RasterLink7 using a printer driver. Margins are especially likely to be created if the print media is set larger than the job in the printer driver settings.
- If [Margin] is set for [Sticker Print] when there are margins surrounding a job, the margins around the job will be deleted, and the specified margins will be inserted between jobs.
- When cutting jobs using a cutting plotter, you must specify whether the left or right register mark should be read first. Using the register mark reference lines enables the register mark read first to be set.

Results of outputting an image using the printer driver

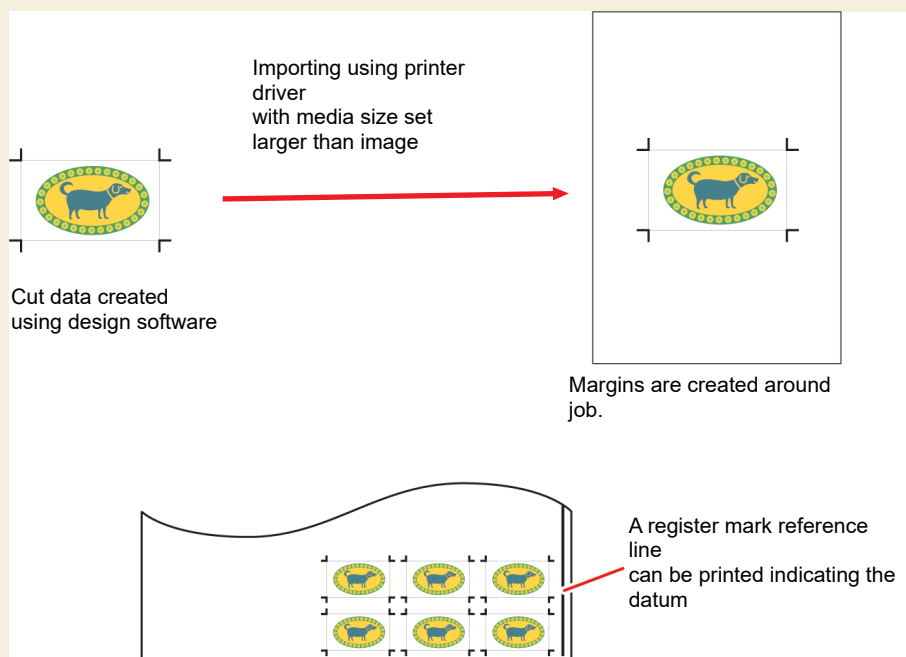

● Print

1 Click the  icon in the preview.

- This starts ripping and printing using the same settings as the last time [Execute] was used. For more information on settings, refer to  "Execute"(P. 127).

2.2.10 Execute

Prints and cuts the selected job.

Important! When RasterLink7 and RasterLink6Plus are installed in one PC and the same printer is registered with each RasterLink via Ethernet connection.

- While printing a job, do not execute the print with another RasterLink. Jobs of another RasterLink can not print.

Execute - Functions

[Execute] allows the following operations.

- Rip and print
- Print and cut
- Estimate ink consumption

● Conditions

In the following cases, [RIP and Print] will be performed automatically, even if [Immediate Print] is set.

- With jobs with [Arrange] set
- With jobs with [Composite] set
- With jobs with [Step & Repeat] set
- When multiple copies are set in [General Print] and [Each move] is set for the move method
- When [Free Location] is selected for [Tiling]
- With print & cut printing jobs
- Jobs with [Variable Edit] Set
- When clear ink is set to be printed two or more times
- When [Print bottom clear liquid] is enabled for glossy print jobs
- When [Add fotoba cut mark] is set

Execute - Screen Layout

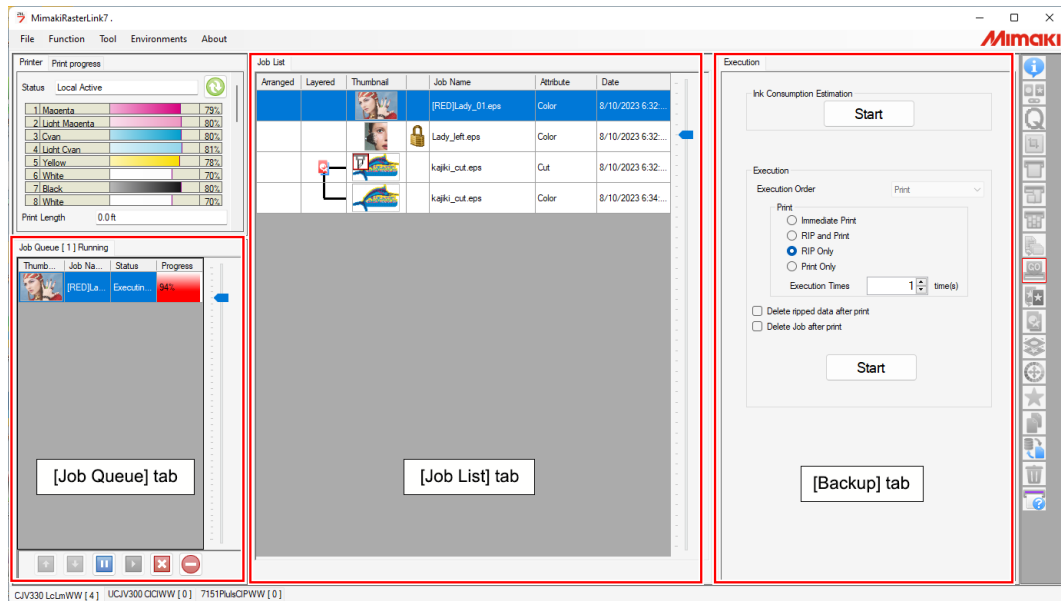

● [Execute] tab

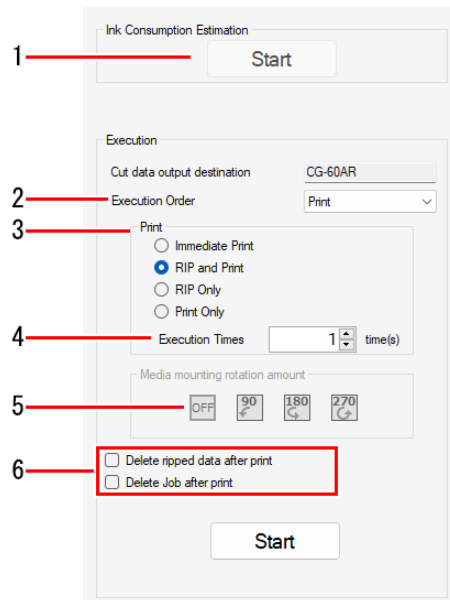

1. [Ink Consumption Estimation]

Estimates how much ink will be used for the jobs selected before ripping or printing. 🖱️ "Estimate ink consumption"(P. 132)

2. [Execution Order]

Selects the execution method (printing & cutting, printing only, or cutting only).



- This will be selected as [Print] for print jobs. The setting cannot be changed.

3. [Print]

Selects the ripping and printing method. 🖱️ "Rip and print"(P. 130)

4. [Execution Times]

Sets the number of output times.

5. [Media mounting rotation amount]



- Displayed only if a cutting device is linked.
- This setting can be changed only when [Cut] is selected for [Execution Order].

Set when you wish to mount media in the cutting device after printing using a different orientation to that used for printing.

For example, this is used in cases such as when the printer and cutting device have different effective widths and the media cannot be mounted unless it is rotated.

6. Execution Option

Sets the deletion process after execution. "Execute - Operations"(P. 130)

● [Job Queue] tab

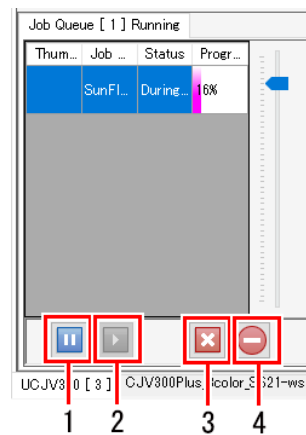

1. Suspend icon

Pauses the processing currently being executed.

2. Resume icon

Restarts processing for a paused job.

3. Stop icon

Stops processing for a selected job.

4. All stop icon

Stops processing for all jobs.



- The [Job Queue] tab displays the status as follows.

Job Queue [0] Running			
Thum...	Job Na...	Status	Progre...

[Running]: Status when job importing, ripping, or printing is possible.

Job Queue [0] Suspending			
Thum...	Job Na...	Status	Progre...

[Suspending]: Status when job importing, ripping, or printing is not being performed.

Job Queue [0] Auto executing			
Thum...	Job Na...	Status	Progre...

[Auto executing]: Status when auto execution "Auto Execution"(P. 235) is in progress.

Execute - Operations

● Rip and print

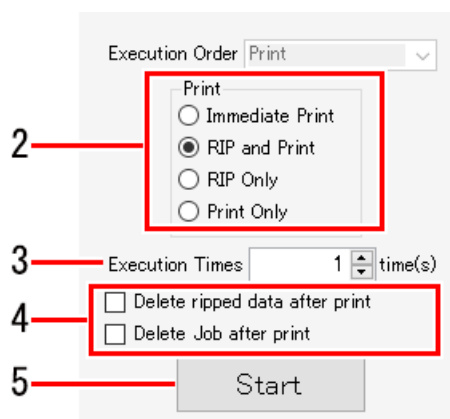

1 Select a job in the [Job List].

2 Select the items in [Print] on the [Execute] tab.

- [Immediate Print]: Rips and prints simultaneously.



- Depending on the printer model and other conditions, [RIP and Print] may be executed automatically, even if [Immediate Print] is set. (☞ "Conditions"(P. 127))
- If the original image data is complex, printing may pause when ripping is unable to keep up with the printing speed. [RIP and Print] should be selected in such cases.
- Ripped data will not be created if [Immediate Print] is selected.

- [RIP and Print]: Printing is executed after ripping is complete. Ripped data is created.
- [RIP Only]: Only ripping is performed. Printing is not performed. Ripped data is created.
- [Print Only]: Only printing is performed.



- [RIP and Print] will be executed automatically if [Print Only] is selected when no ripped data has been created.
- Hovering the mouse over a job on the [Job List] tab displays various status information for that job. Bold job names on the [Job List] tab indicate jobs for which ripped data has been created.

3 Enter the number of times for executing ripping and printing in [Execution Times].



- Ripped data will not be created if [Immediate Print] is selected. Ripping and printing will be executed just for the number of times set.

4 Set the deletion processing for data after printing in Execution Option.

- [Delete ripped data after print]: When this is selected, ripped data will be deleted after printing if the execution order is set as [RIP and Print] or [Print Only].
- [Delete Job after print]: When this is selected, the job will be deleted after printing if the execution order is set as [Immediate Print], [RIP and Print], or [Print Only].

5 Click [Start].

- The processing specified for [Print] starts.

● Print and cut (with a print & cut machine and ID cut job)

1 Select a job in the [Job List].

2 Select the required items from the [Execution Order] list.

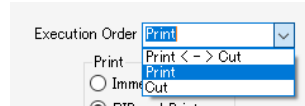

- [Print <-> Cut]: Prints and cuts.
- [Print]: Only printing is performed.
- [Cut]: Only cutting is performed.

3 Select the items in [Print].

- The item details are the same as for "Rip and print"(P. 130).

4 Enter the number of times for executing printing and cutting in [Execution Times].

5 Set the deletion processing for data after printing.

- The item details are the same as for "Rip and print"(P. 130).

6 Click [Start].

- Printing and cutting starts.

● Print and cut (with a linked cutting device)

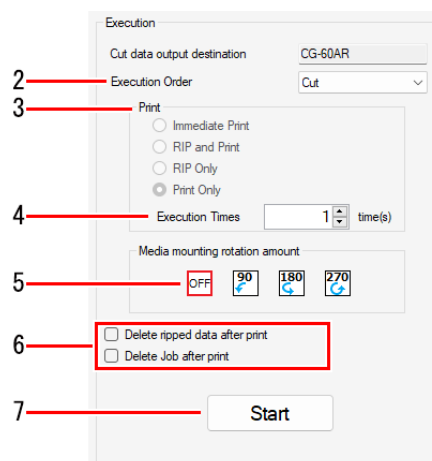

1 Select a job in the [Job List].

2 Select the execution method from the [Execution Order] list.

Important! If a cutting device is linked

- To output print data to a printer, select [Printer].
- To output cut data to a cutting device, select [Cut].

3 Select the items in [Print].

- The item details are the same as for  "Rip and print"(P. 130).

4 Enter the number of times for executing printing and cutting in [Execution Times].

Important! • When cutting using a cutting device after printing, be sure to set the same number of execution times for both printing and cutting.

5 If [Cut] is selected for [Execution Order], select [Media mounting rotation amount]. "[Execute] tab"(P. 128)

6 Set the deletion processing for data after printing.

- The item details are the same as for  "Rip and print"(P. 130).

7 Click [Start].

- Printing or cutting starts.

● Estimate ink consumption

Calculate how much ink will be used for the jobs selected before ripping or printing.

Important! • This function can be used when RasterLink7 is connected to a printer with the power turned on.



- The data used for estimation is set in [Option] - [Job Control]. ( "[Option]"(P. 240))
The processing speed and accuracy will vary depending on the settings.
- This function cannot be used if the [Calculate Ink Consumption] check box is selected on the [Option] window and the job has already been ripped or printed, as ink consumption is calculated based on the ripping results.

1 Select a job in the [Job List].



- It can be used even when multiple jobs are selected.

2 Click [Ink Consumption Estimation] on the [Execute] tab.

- The ink saving settings are displayed for printers that support ink saving.
 "Print with reduced ink consumption"(P. 67)
These settings can be used to check variations in the ink levels due to the ink saving settings.
- The progress indicator window is displayed while processing is in progress.

3 Once processing is complete, the results can be checked in either of the following two ways:

- [Properties] window for each job
Values for [Ink Consumption (Estimation)] are displayed in the [Results] column for each job.

Ink Consumption (Estimation)	
Cyan	0.945 cc
Magenta	2.004 cc
Yellow	3.068 cc
Black	1.294 cc
Light Cyan	5.635 cc
Light Magenta	9.527 cc
White	0.000 cc
White	0.000 cc
Total	22.473 cc

- [Log] window
The results are displayed on the log window.
If multiple jobs were selected, the total value is displayed.

```

Log Display
[Thursday, August 10, 2023 7:46:50 PM] - [RIP] Started Ink Consumption Estimation : [kajiki_cut.eps,kajiki_cut.eps]
[Thursday, August 10, 2023 7:46:51 PM] - [RIP] Completed Ink Consumption Estimation : [kajiki_cut.eps,kajiki_cut.eps]
[Thursday, August 10, 2023 7:46:52 PM] - [RIP] Completed Ink Consumption Estimation : [DIC_mix_091.pdf]
[Thursday, August 10, 2023 7:46:53 PM] - [UI] The total ink consumption of the selected 4 job(s) is as follows.
[Thursday, August 10, 2023 7:46:53 PM] - [UI] C:1.158cc, M:2.121cc, Y:3.244cc, K:1.303cc, Lc:5.76Tcc, Lm:9.659cc, W:0.000cc, Total:23.246cc
  
```

2.2.11 Special plate

Creates a job specifically for a special color ink from the selected job.

Special plate - Functions

[Special plate] allows the following operations.

- Create a special color job
- Create a special color job and combine it with the original job
- Create a special color job automatically when an image is imported



- With RasterLink7, jobs for which [Special plate] is created are referred to as special color jobs.

● Conditions

[Special plate] cannot be set in the following cases.

- When a special color inkset has not been set for the printer

[Special plate] cannot be set for jobs with the following settings.

The following settings should be canceled initially when setting [Special plate].

- [Arrange]
- [Tiling]
- [Step & Repeat]
- [Composite]
- [Jig Print]
- Special plate job

Special plate - Screen Layout

● [Special plate] screen

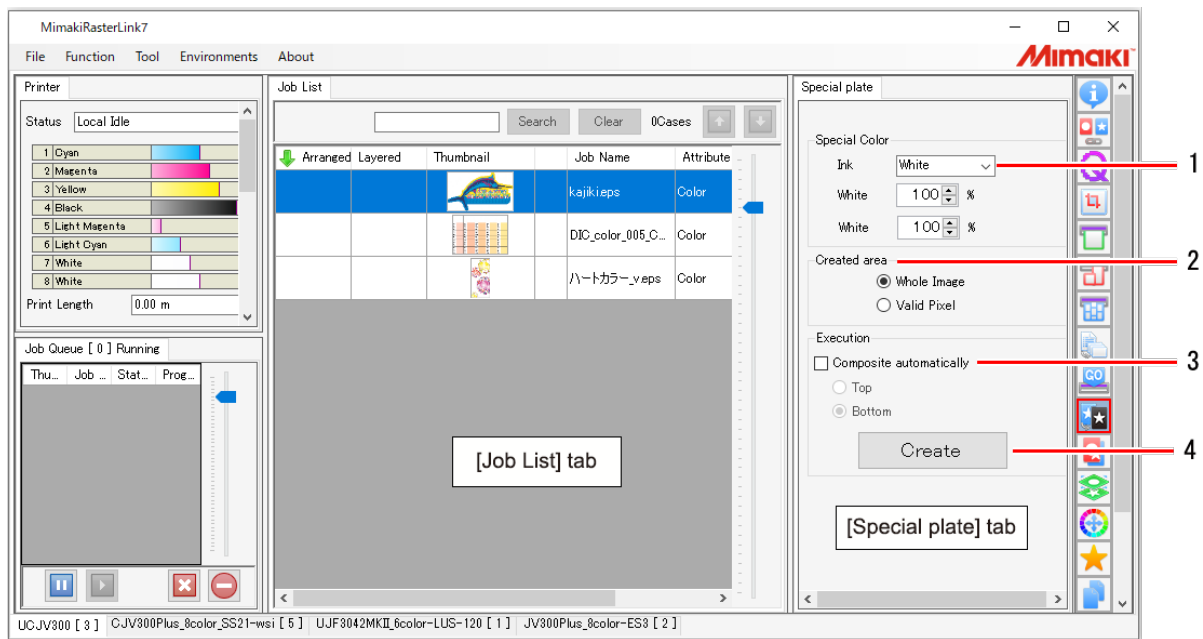

1. [Special Color]

Sets the special color ink.

2. [Special Color Print Area]

Sets the area in which the special color ink is output.

3. [Composite automatically]

Sets the composition for the special color job and the original job.

4. [Create]

Clicking the button creates a special color job.

Special plate - Operations

● Create a special color job

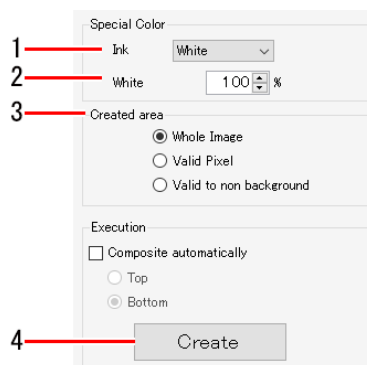

1 Select the special color ink from the [Ink] list in Special Color Ink on the [Special plate] tab.

- The special color inks available will vary depending on the special color inkset in the printer being used.



- Only one special ink can be selected. More than one special color ink cannot be selected simultaneously.

2 Set the ink density (%).

- The default value is 100%.



- Special color jobs created using [Special plate] will be replaced by mono color solid special color data ignoring the color density of the original image.
- With [Special plate], the ink density of a special plate job will be the ink density set in [Special Color] at the time of creation or the ink density set in ["Editing the settings for a special color job created using Special plate"](#)(P. 36). The density of the special color ink cannot be varied within a single special color job.
- If you wish to vary the special color ink density within a single special color job, such as when using gradations, create the special color image data, then set the special color ink as described in ["Print a full-color job in monotone"](#)(P. 35).

3 Select [Special Color Print Area].

- [Whole Image]: Prints the entire rectangle of the original image using the special color ink.
- [Valid Pixel]: Outputs special color ink only where there is color in the original image.
- [Valid to non background]: Outputs special color ink where there is data (including white) in the original image.

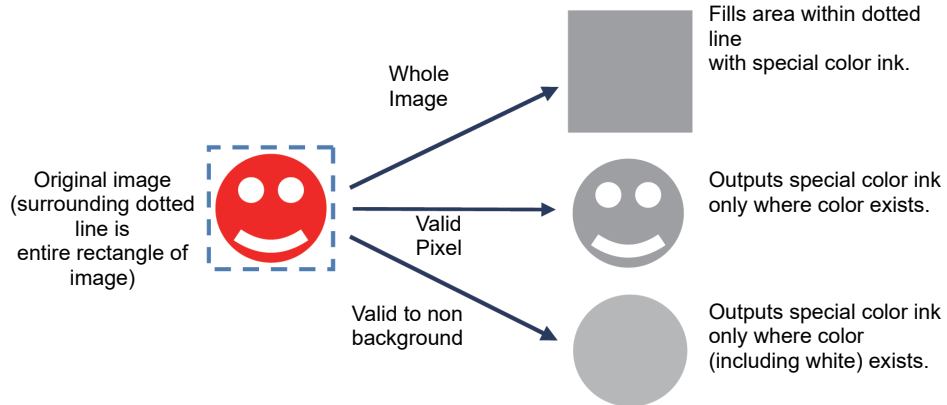

Conditions under which [Valid to non background] is applied

- The image data format is EPS, PS, or PDF, and color (including white) is specified in the data portion.

- If filled with white

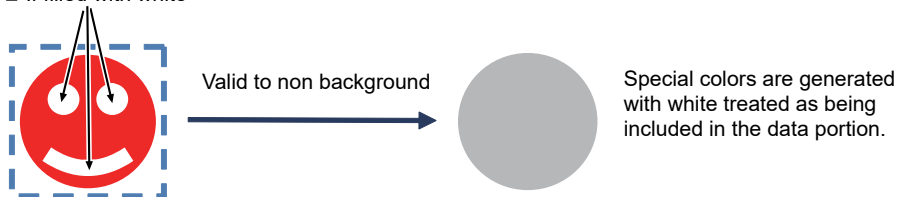

- If transparent

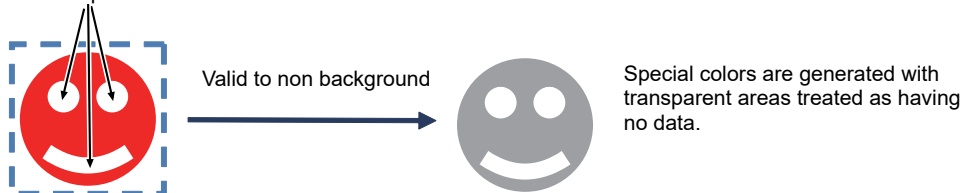

Important!

- To place TIFF data with transparency, save the image as a PDF. For images saved in EPS or PS format, special colors are generated with the rectangle of the TIFF data treated as the data portion.

Placing TIFF data with transparency in an image

- When the entire image is saved as a PDF

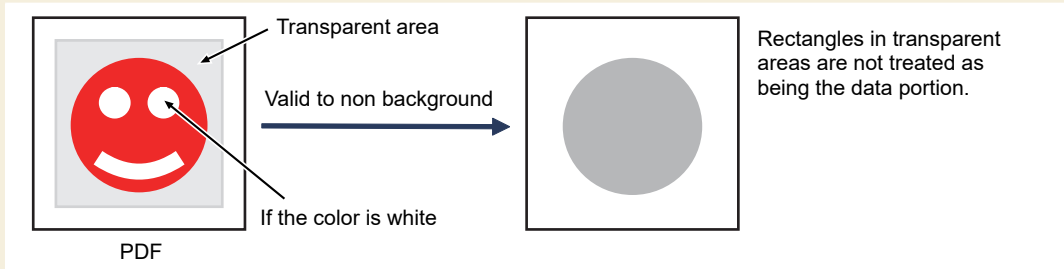

- When the entire image is saved in EPS or PS format

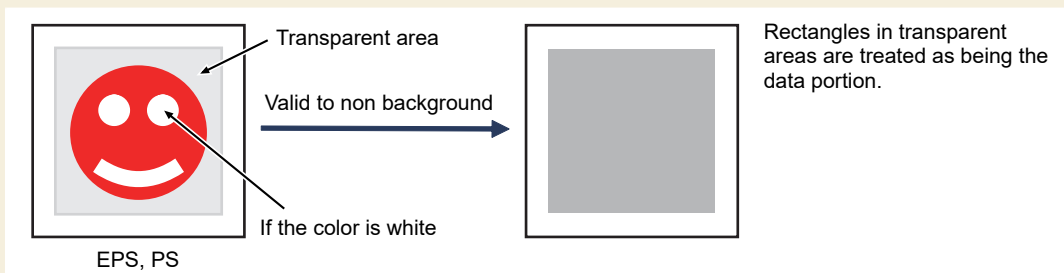

- To fill the interior of the figure completely with special color ink as shown below without using the [Valid to non background] setting, create special color data using design software, then set the special color ink as described in ["Print a full-color job in monotone"\(P. 35\)](#).



- When you use Adobe Illustrator for the design software, special color data like that described above can be created easily using RasterLinkTools. For more information, refer to "A special color is printed over the entire image." in the separate "RasterLinkTools Guide".
- If image data includes objects with density less than 1%, these may be included in the printed output recognized as valid pixels even if they do not seem to be recognized as valid pixels in the preview. To have these objects recognized as valid pixels in previews, set object density to at least 1% in the design software.

4 Click [Create] in [Execute].

- A special color job is created and added to the job list.



- Depending on the ink and UV mode set for a special color job, colors similar to those shown below will be displayed in [Thumbnail] on the [Job List] tab. For more information on UV mode settings, refer to ["Edit UV settings"\(P. 36\)](#)

Thumbnail	Attribute
	ClearPlate Type(Glossy)
	ClearPlate Type(Matte)
	White

- "Clear (UV Mode)" is displayed in [Attribute] for special color jobs created by selecting "Clear".

● Create a special color job and combine it with the original job

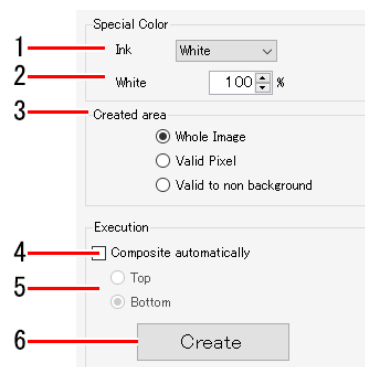

1 Select the special color ink from the [Ink] list in [Special Color] on the [Special plate] tab.

2 Set the ink density (%).

3 Select [Special Color Print Area].

4 Select the [Composite automatically] check box.

5 Select the [Execute] items.

[Top]: Combines by laying the special color job over the original job.

[Bottom]: Combines by laying the special color job under the original job.

6 Click [Create].



- The composition of composite jobs can be canceled using "Composite" ["Composite"\(P. 140\)](#).
- When creating multiple special color jobs and combining them (such as when creating white and clear special color jobs from a single job), special plates cannot be created from composite jobs, so unselect the [Composite automatically] check box, create the special color jobs, then use "Composite" ["Composite"\(P. 140\)](#).

2.2.12 Composite

Combines multiple jobs on top of each other.

Composite - Functions

[Composite] allows the following operations.

- Select a composite job and set the output sequence
- Select print & cut job and set the output sequence.
- Compose by reversing jobs
- Set the priority policy (with flatbed printers)
- Overlay print by pulling back the media after printing*¹
- Print overlapping plates with the same job attributes (with flatbed printers)*¹

*1. Not available with all models.

● Conditions

The job overlay method will vary depending on the individual printer model and job attributes.

● With roll-to-roll printers

- **Combining color jobs**

All jobs are overlaid and printed at the same time.

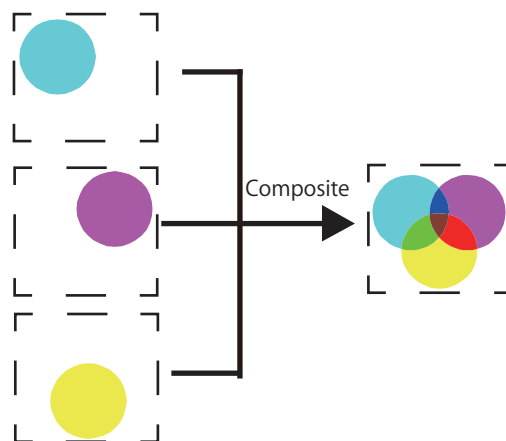

- **Combining special color jobs with color jobs**

The printing methods that can be set will vary depending on the particular roll-to-roll printer model.

The following printing methods can be used when combining special color jobs with color jobs.

Model	Special Color Over Print	No Special Color Over Print	Pull-back print
UJV55-320 JV300 Plus JV330 CJV330	Prints using the following two methods. <ul style="list-style-type: none"> • 2-layer printing of the colors and special color simultaneously • 3-layer printing in the sequence colors ⇒ special color ⇒ colors 	Creates image data combining colors and special color, then prints simultaneously.	Not supported.
JV300	Prints using the following two methods. <ul style="list-style-type: none"> • 2-layer printing of the colors and special color simultaneously • 3-layer printing of the colors and special color in any sequence 		Not supported.
CJV300 CJV150 CJV300 Plus	Prints using the following two methods. <ul style="list-style-type: none"> • 2-layer printing of the colors and special color simultaneously • 3-layer printing of the colors and special color in any sequence 		Pulls back the media after one job has been printed, then prints the remaining job(s) on top of the first job.
UCJV300 UCJV330	Prints using the following four methods. <ul style="list-style-type: none"> • 2-layer printing of the colors and special color simultaneously • Print three layers in the following order Color ⇒ Special color ⇒ Color Special color ⇒ Color ⇒ Special color • Prints four layers in the sequence(*) colors ⇒ shade ⇒ special color ⇒ colors colors ⇒ special color ⇒ shade ⇒ colors 		This is used in three-layer printing including clear (glossy). For more information, refer to the "UCJV300/330 Clear Ink Printing Guide".

	<ul style="list-style-type: none"> 5-layer printing in the sequence colors ⇒ special color ⇒ shade ⇒ special color ⇒ colors(*) 		
UJV100	Print two layers of color and spot color at the same time	Not supported.	Not supported.
TxF150 TxF300	Prints using the following two methods: <ul style="list-style-type: none"> Special color ⇒ Color 	Not supported.	Not supported.
UJV100Plus	Print two layers of color and spot color at the same time	Not supported.	<p>Pulls back the media after one job has been printed, then prints the remaining job(s) on top of the first job.</p> <p>Enable Auto deskew to print with skew corrected after media is pulled back.</p> <p> P. 150</p>
Roll-to-roll printers other than those above	Not supported.	Creates image data combining colors and special color, then prints simultaneously.	Not supported.

(*)For more information, refer to the separate "Multi-layer Printing Guide".

Example: Combining a color job with a special color (white) job

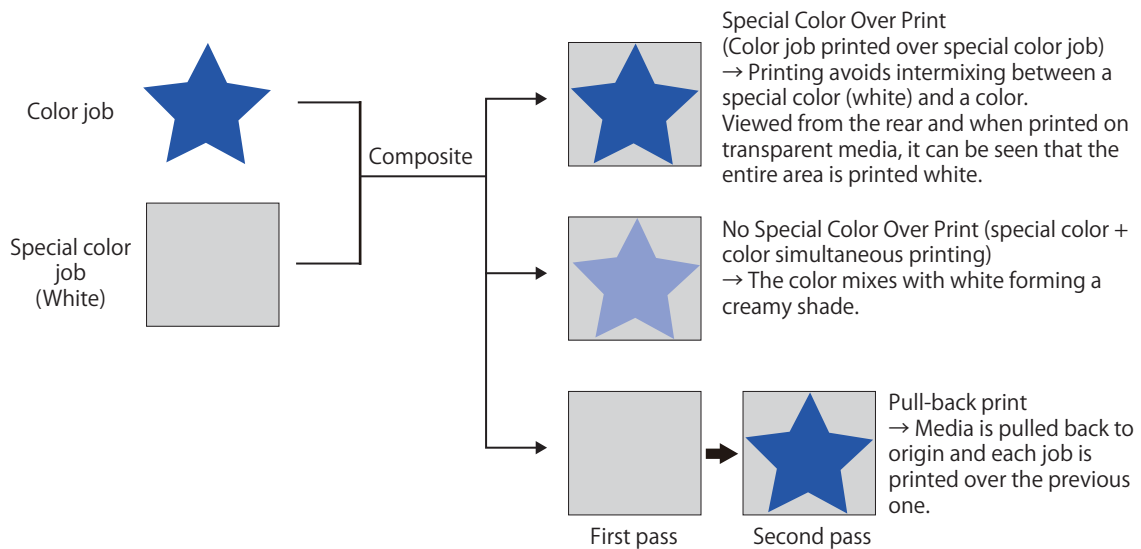

● With a flatbed printer

With flatbed printers, the printing method will vary depending on the "Priority policy" set with the [Composite] function  "Set the priority policy (with flatbed printers)"(P. 150).



- If jobs with different device profiles are combined using [Speed], they will be combined using the same conditions as for [Quality].
- If jobs with different resolutions are combined using [Speed], they will be combined using the same conditions as for [Quality].

• Combining color jobs

The following printing methods can be used when combining color jobs.

With [Priority policy] set to [Speed]

Data is created with all jobs overlaid and then printed at the same time.

With [Priority policy] set to [Quality]

Jobs are printed individually. Once printing is completed, the printer returns to the origin and prints the next job over the previously printed job.

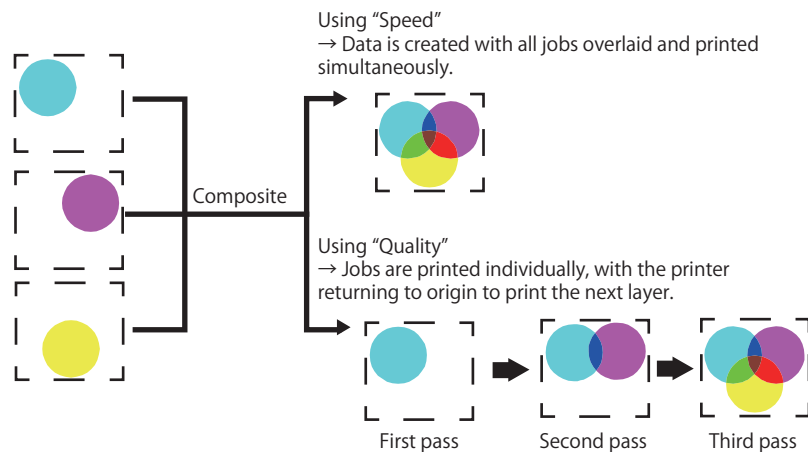

• Combining special color jobs with color jobs

The following printing methods can be used when combining special color jobs with color jobs.

With [Priority policy] set to [Speed]

The Special Color Over Print function is used to print two color job and special color job layers simultaneously.

With [Priority policy] set to [Quality]

Jobs are printed individually. Once printing is completed, the printer returns to the origin and prints the next job over the previously printed job.



- When color jobs and special color jobs are combined when using a flatbed printer, these will always be printed in layers. Color and special color jobs cannot be printed simultaneously as with roll-to-roll printers.
- If using an inkset containing light cyan and light magenta, printing will use the same method as for [Quality] even when [Speed] is selected. (This applies only when special color ink and light ink are arranged inline. Perform a test print to check.)
- If the special color job is clear, the printing method will vary depending on the "UV Mode" settings. For more information, refer to Properties  P. 39.

Example: Combining a color job with a special color (white) job

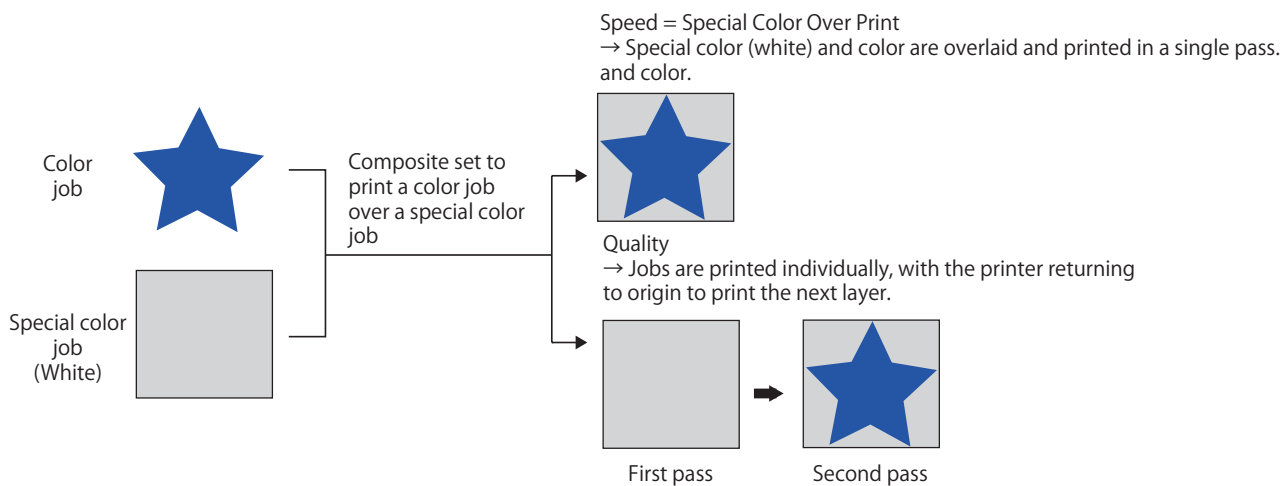

Composite - Screen Layout

● [Composite] screen

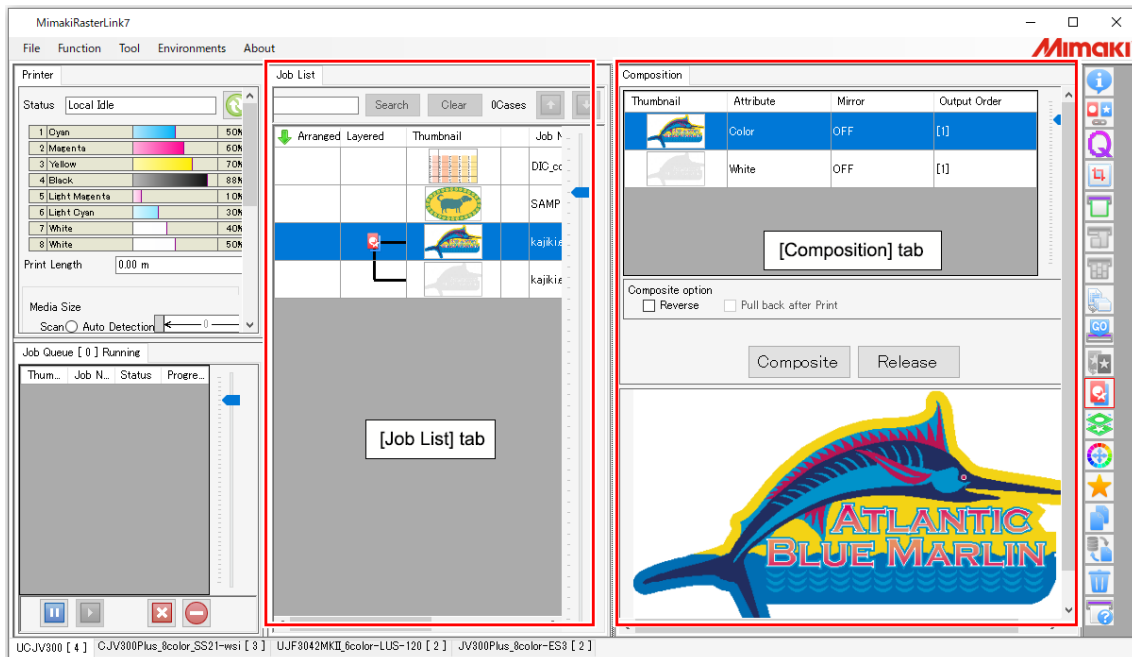

● [Job List] tab

Displays the composed job.

● [Composite] tab

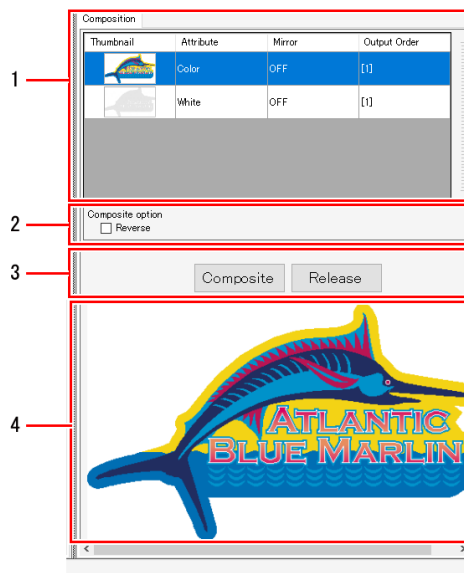

1. Composite list

Displays the multiple jobs included in the composite.

2. [Composite option]

Sets the composition method.

3. [Composite]/[Release]

Creates or cancels a composite job.

4. Composite preview

Displays the preview showing the composite job.

- For UCJV330

When creating data for multi-layer printing and watermark printing with RasterLinkTools and loading the RL output data via a hot folder, previews can be checked with the light on and off.

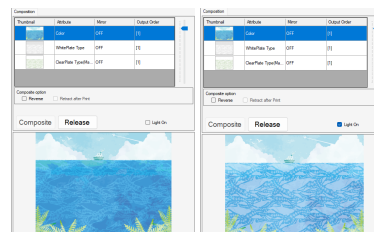

Light off



Light on

Composite - Operations

● Select a composite job and set the output sequence



1 Select the multiple jobs to be composed and printed in the [Job List] window.

- The selected jobs are displayed in the composite list on the [Composite] tab.

Thumbnail	Job Name	Attribute
	sample 1.eps	Color
	sample 1.eps	White

2 The jobs displayed in the composite list on the [Composite] tab can be reordered by dragging and dropping.

- The jobs will be printed in sequence from the bottom of the composite list.

Composition			
Thumbnail	Attribute	Mirror	Output Order
	Color	OFF	[1]
	White		[1]

↑ Drag & Drop

3 Click [Composite] in [Composite]/[Release] on the [Composite] tab.

- The [Job List] is refreshed and the selected jobs are linked by lines.

Job List				
↓ Arranged	Layered	Thumbnail	Job Name	Attribute
			sample 1.eps	Color
			sample 1.eps	White





- [Composite] must be clicked again if the job sequence in the composite list is altered after composition.

● Select print & cut job and set the output sequence.



1 Select the multiple jobs to be composed and printed in the [Job List] window.

- The selected jobs are displayed in the composite list on the [Composite] tab.

Thumbnail	Job Name	Attribute
	kajiki.eps	Cut
	kajiki.eps	Color
	kajiki.eps	WhitePla...

2 The jobs displayed in the composite list on the [Composite] tab can be reordered by dragging and dropping.



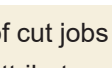



- The jobs will be printed in sequence from the bottom of the composite list.

Composition			
Thumbnail	Attribute	Mirror	Output Order
	Cut	OFF	[2]
	Color		[1]
	WhitePlate Type	OFF	[1]

↑ Drag & Drop

Important! About the placement of cut jobs

- Jobs with the cut attribute must be placed at the top or bottom of the composite list.
- Cut jobs are generally placed at the top, but on the following models, a cut job can be placed at the bottom to create a "Cut & Print (cut-then-print) job."
CJV150, CJV300, CJV300Plus, CJV330, CJV200

Job List				
Arranged	Layered	Thumbnail	Job Name	Attribute
			kajiki.eps	Color
			kajiki.eps	WhitePla...
			kajiki.eps	Cut

- Note, however, that setting registration mark detection for cut-and-print jobs will cause detection errors during cutting.

3 Click [Composite] in [Composite]/[Release] on the [Composite] tab.

- The [Job List] is refreshed and the selected jobs are linked by lines.

Job List				
Arranged	Layered	Thumbnail	Job Name	Attribute
			kajiki.eps	Cut
			kajiki.eps	WhitePla...
			kajiki.eps	Color



- With roll-to-roll printers, the job will be printed in the order of the numbers indicated in the [Output Order] column. (With flatbed printers, printing will be in sequence from the bottom.)
Example: When the special color job (white) output sequence is 1 and the color job output sequence is 2



The color ink will be printed on top of the white.



- If the jobs differ in size, the bottom left of the largest job will be used as the datum for overlaying.

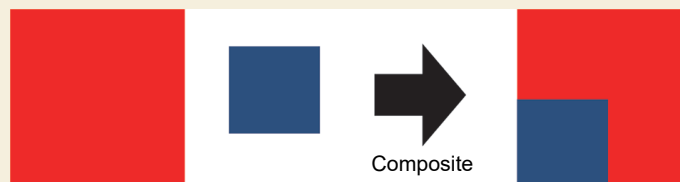

- If you are creating composite image data using design software, data should be created using one of the following two methods.
 - Align the vertical and horizontal size.
 - Adjust the position with the bottom left as the origin.



- When multiple jobs are combined, the settings for the job at the top of the [Job List] are applied to all of the jobs. The following settings will be applied.
 - [Scale]
 - [Rotation]
 - [Mirror]
 - [Print Condition]



- Do not composite print a job that is set to mono color printing and a job that is created from that. The printer does not print correctly.

● Compose by reversing jobs

- 1 Select a job to be reversed in the composite list.

2 Select the [Mirror] check box in [Composite option].

- The selected job is reversed.

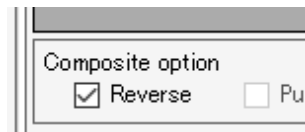

- Difference between [Mirror] on the [General Print] screen and [Mirror] on the [Composite] screen

Setting [Mirror] on the [General Print] screen reverses all composite jobs.

Setting [Mirror] on the [Composite] screen reverses only the selected job(s).

Using [Mirror] on the [General Print] screen and on the [Composite] screen with the composite list below will have the following results.

Thumbnail	Attribute	Mirror	Output Order
	Color	OFF	[1]
	White	ON	[1]

Composite option
 Reverse

Example 1: Setting [Mirror] as follows

- Job with white attribute enabled on [Composite] screen
- [General Print] screen: OFF



Only the special color job (white) is reversed.

Example 2: Setting [Mirror] as follows

- Job with white attribute enabled on [Composite] screen
- [General Print] screen: ON



Reversed version of Example 1, i.e. only the color job is reversed.



- In cases where the printed face is viewed from the opposite side, such as with transparent media, set [Mirror] on the [General Print] screen after composition.

3 Click [Composite].

● Set the priority policy (with flatbed printers)

1 Set the [Priority policy] items in [Composite option] on the [Composite] tab.

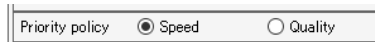

- [Speed]
Reduces printing time by using the Special Color Over Print function. This is useful when completing the job quickly is more important.
- [Quality]
Quality takes precedence when jobs are printed individually. This is useful when an attractive finish is more important.



- Jobs are printed one at a time when [Quality] is selected. The printing speed and quality can therefore be adjusted by altering the resolution for each job individually. For example, a special color job (white) for which you wish speed to take priority can be set with low resolution, and a color job for which you wish quality to take priority can be set with high resolution before combining.
For more information, refer to "Print Condition"(P. 56).

2 Click [Composite].

● Overlay print by pulling back the media (with CJV300, CJV150, CJV300 Plus, UCJV300, UCJV330, and UJV100 Plus)

1 Select the [Pull back after Print] check box in [Composite option] on the [Composite] window.

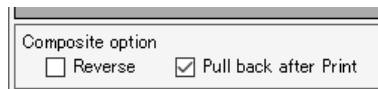

- Pulls back the media to the origin position after jobs selected from the composite list have been printed simultaneously, then prints the remaining job(s).
- This is useful when you wish to print colors after allowing a special color to dry thoroughly, such as when color jobs are combined with special color jobs.



- The media is always pulled back between printing and cutting in the case of print & cut jobs.
The [Pull back after Print] check box cannot be unselected.

2 Click [Composite].



Auto deskew (compatible model: UJV100Plus)

Auto deskew correction is available when the [Retract after Print] check box is selected.

With the [Auto deskew] check box selected, after media is pulled back, image data skew is automatically detected and corrected before printing.

Skew detection register marks are automatically added to the first image data to print.

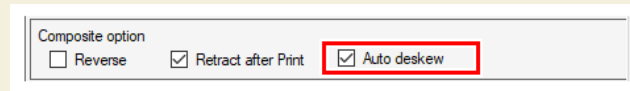

- Example: With Auto deskew activated when printing special colors before regular colors

(1) Jobs are printed with register marks added to the special color layer.

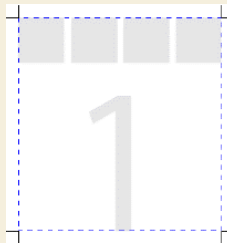

- Media is pulled back, the marks are detected, and the skew is calculated.

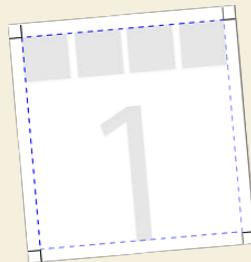

(2) After special color printing is finished, the skew angle is applied when ripping the regular color layer.



(3) The color layer is printed.

- Print overlapping plates with the same job attributes (with flatbed printers)

- 1 Select the bottom job of those with the same attributes, then select the [Pull back after Print] check box in [Composite option] on the [Composite] window.

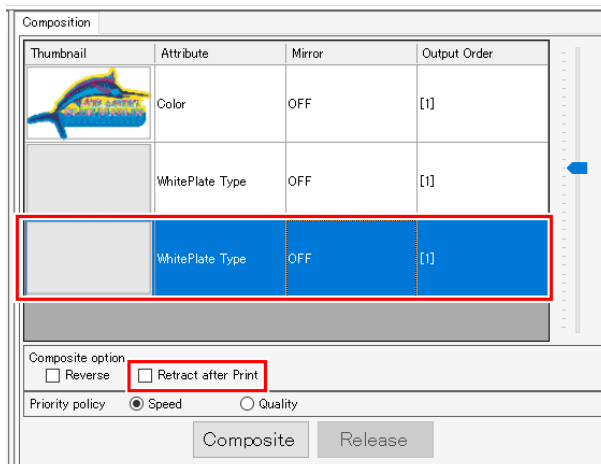

- The output order will be changed.

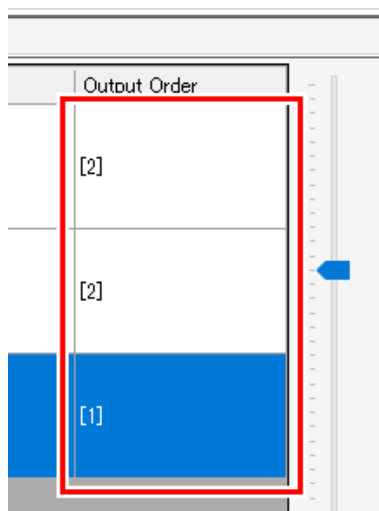

- A white plate can be overlay printed using a separate feed.

Important! • This is available when [Speed] has been selected for the Priority policy.

- 2 Click [Composite].

- Canceling composition

- 1 Select the job(s) for which composition is to be canceled in the [Job List].
- 2 Click [Composite] in the [Function] menu or the Composite function icon ().
- 3 Click [Release] on the [Composite] tab.
 - The composition containing the selected jobs is canceled.

2.2.13 Layer

Configures the detailed settings for jobs printed with color and special color ink.

Layer - Functions

[Layer] allows the following operations.

- Set Special Color Over Print*¹
- Set Special Color Over Print quality*¹
- Adjust the special color position
- Adjust the special color size

*1. Not available with all models.

● Conditions

[Layer] can be used in the following cases.

- When a special color inkset is set

Special Color Over Print can be set when using printers that support Special Color Over Print.

Important! Special Color Over Print is a function that allows special colors (white, silver, primer, clear) to be printed over colors in a single printing process. This can be used in the following cases.

- When special colors and colors are "composed"  ["Composite"\(P. 140\)](#)
- When certain colors in a color image have been replaced by special colors

Models supporting Special Color Over Print

Model	Compatible inks
CJV150	White, silver
CJV300	White, silver
CJV300 Plus	White, silver
CJV330	White
JV300	White
JV300 Plus	White
JV330	White
JFX200EX	White, primer, clear
UCJV300	White, clear
UCJV330	White, clear
UJV100	White, clear
UJF-3042MkII	White, primer, clear
UJF-6042MkII	White, primer, clear
UJF-7151	White, primer, clear

Model	Compatible inks
UJV55-320	White
JFX600	White, primer, clear
UJF-7151plusII	White, primer, clear
UJF-3042MkII e	White, primer, clear
UJF-6042MkII e	White, primer, clear
TxF150	White
TxF300	White
UCJV330	White, clear
UJV100 Plus	White, clear

Layer - Screen Layout

● [Layer] screen

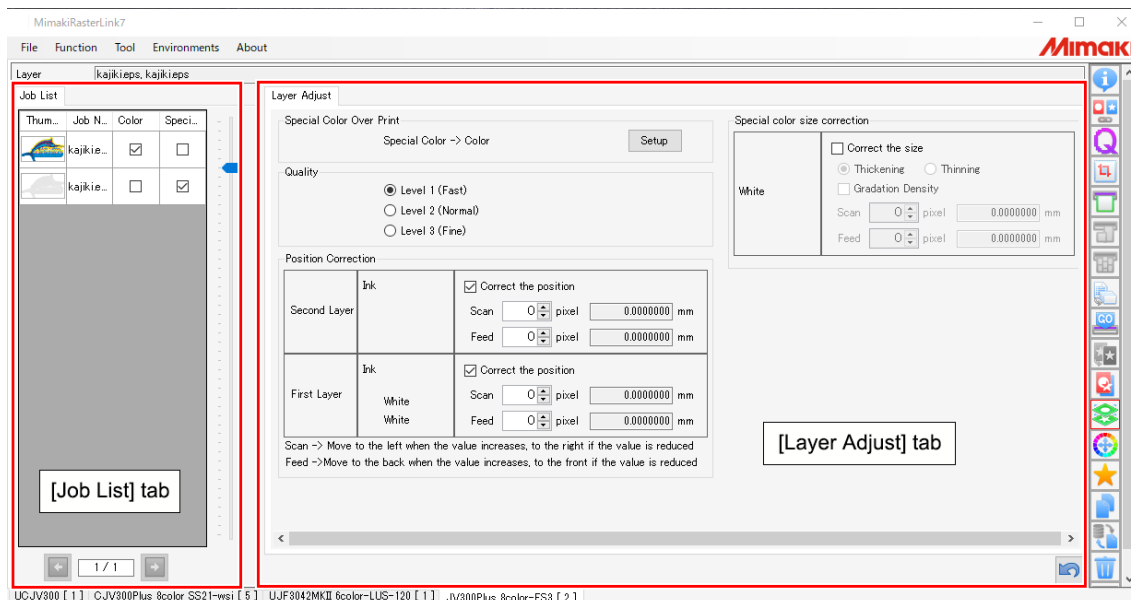

● [Job List] tab

Displays the job to be edited.

[Layer] is set for each print if the [Composite] function has been set to print divided into multiple passes.

Jobs to be printed simultaneously are displayed.

Clicking the [←] [→] icons at the bottom of the [Job List] tab lets you switch between jobs.

Example: Setting to print with three passes using the UJF-6042MkII

[Composite] tab on the [Composite] screen

Thumbnail	Attribute	Mirror	Output Order
	ClearPlate Type	OFF	[3]
	Color	OFF	[2]
	White	OFF	[2]
	PrimerPlate Type	OFF	[1]

Output order

First pass: Special color job (primer)

Second pass: Special color job (white) and color job

Third pass: Special color job (clear)

[Job List] tab on the [Layer] screen

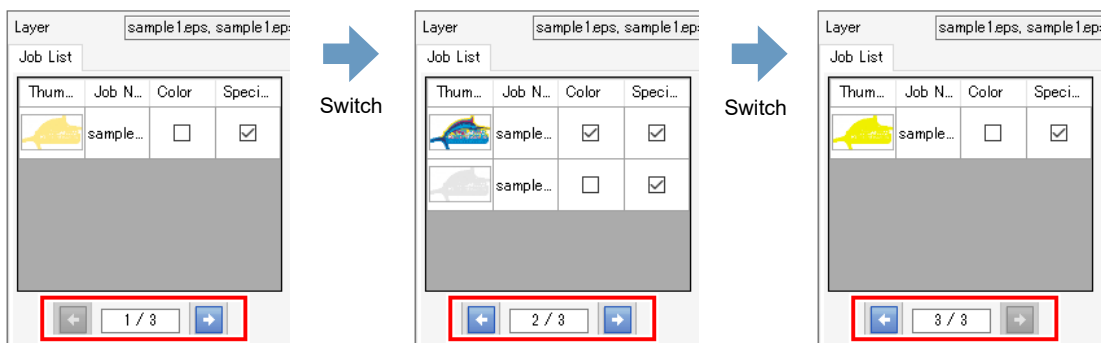

First pass:
Special color job
(primer)

Second pass:
Special color job
(white)
and color job

Third pass:
Special color job
(clear)

● **[Layer Adjust] tab**

Sets Special Color Over Print and the special colors.

Example: A composed special color job (white) and color job printed using the JV300 Plus

• The details displayed will vary depending on the model, special ink type, and whether or not composition is used.

1. [Special Color Over Print] (with models supporting Special Color Over Print)

Sets Special Color Over Print.

2. [Quality] (with models supporting Special Color Over Print)

Set the quality of Special Color Over Print.

3. [Position Correction]

Adjusts the special color position.

4. [Special color size correction]

Adjusts the special color size.

Layer - Operations

- **Set Special Color Over Print (with models supporting Special Color Over Print)**

- 1** Select the job to be set for Special Color Over Print on the [Job List] tab.
- 2** Click [Layer] in the [Function] menu or the [Layer] function icon (.
- 3** Select a job in the [Job List].

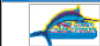
Composition			
Thumbnail	Attribute	Mirror	Output Or
	ClearPlate Type	OFF	[3]
	Color	OFF	[2]

- 4** Select [Special Color Over Print] on the [Layer Adjust] tab.

- This allows you to set whether or not to use Special Color Over Print.
- If selected, the printing order can then be selected.

- **Set the quality of Special Color Over Print (with models supporting Special Color Over Print)**



The quality of Special Color Over Print can be set in the following case.

- With models that support quality settings for Special Color Over Print and when Special Color Over Print is set to be used

- 1** Select the job to be set for Special Color Over Print on the [Job List] tab.
- 2** Click [Layer] in the [Function] menu or the [Layer] function icon (.

3 Select [Quality] on the [Layer Adjust] tab.

- The quality increases from Level 1 to Level 3, but the printing speed will also be reduced.

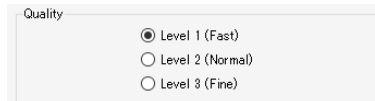



● Adjust the special color position

1 Select the job to be set for Special Color Over Print on the [Job List] tab.

2 Click [Layer] in the [Function] menu or the [Layer] function icon (🔗).

3 Select the special color job to adjust its position on the [Job List] tab.

Composition			
Thumbnail	Attribute	Mirror	Output Or
	ClearPlate Type	OFF	[3]
	Color	OFF	[2]

4 Select the [Correct the position] check box for the layer on which the special color is to be printed in [Position Correction] on the [Layer Adjust] tab.

5 Enter the number of pixels (-99 to 99 pixels) for [Scan] and [Feed].

- The special color position is altered for the selected job.



- [Position Correction] should be used when there is a slight offset between special colors (such as white and clear) and colors when printing.

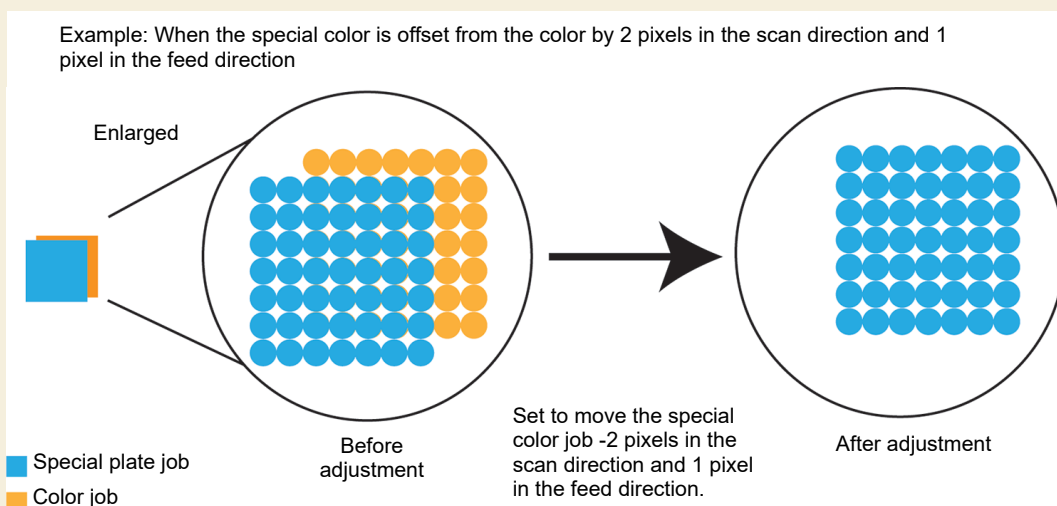

● Adjust the special color size

1 Select the job to be set for Special Color Over Print on the [Job List] tab.

2 Click [Layer] in the [Function] menu or the [Layer] function icon (🔗).

3 Select a job for which special ink is to be printed on the [Job List] tab.

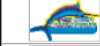
Composition			
Thumbnail	Attribute	Mirror	Output Or
	ClearPlate Type	OFF	[3]
	Color	OFF	[2]

4 Select the [Correct the size] check box for the layer on which the special color ink is to be printed in [Position Correction] on the [Layer Adjust] tab.

5 Select the required items.

- [Thickening] or [Thinning] can be selected.

6 Enter the number of pixels in [Scan] and [Feed].

- The special color size is altered for the selected job.



- The size setting method is the same for all models.
- [Special color size correction] is useful in the following cases.
 - When you wish to print clear ink to cover a color job
 - When you wish to print a special color (white or primer) slightly smaller because the white or primer ink printed as the base will be printed protruding from the color

Example: To thicken the special color job by 2 pixels in both the scan direction and feed direction

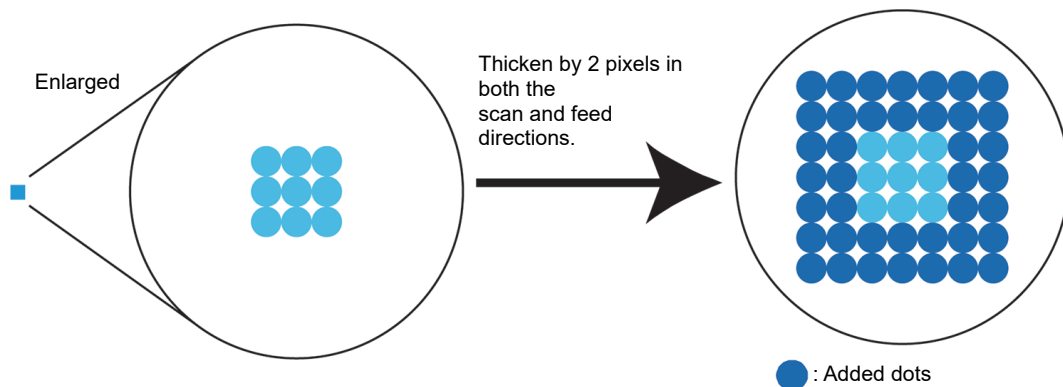

2.2.14 Color Replacement

Replaces the job colors with different colors.



- With RasterLink7, replacing specific job colors with different colors is referred to as "color replacement".

Color Replacement - Functions

[Color Replacement] allows the following operations.

- Replace a spot color or CMYK
- Replace a gradation color
- Replace a color using a colorimeter
- Use a color collection
- Select from a color collection
- Register to a color collection
- Create a color chart with the Lab value after replacement as the base color

● Conditions

image data

Color replacement is possible when using the following original data.

Color mode	CMYK
File format	ps, eps, pdf
Object	Vector data

Important! Colors cannot be replaced in raster data.

If using vector data containing the following effects, correct printing may not be possible even when colors have been replaced.

- Objects created with filter effects such as drop shadow, transparency, and blurring in Adobe Illustrator
- Gradation objects created in Adobe Illustrator with compatible gradation and gradation mesh printing selected

Important! If a PDF file set to contain an embedded profile is saved, color replacement will not take place even if it is set to do so.

The following warning message will appear for such jobs:

"This job contains an embedded profile. It may be printed without CMYK or Gradation color replacement."

If you wish to use CMYK or gradation color replacement with a PDF file, ensure it is saved so as not to contain an embedded profile.

Colors that can be replaced

The following color data can be replaced.

- Spot colors (colors such as special named colors, metallic, or fluorescent colors that cannot be represented using CMYK combinations, also referred to as special colors)
For more information on precautions, refer to  ["Precautions when replacing spot colors"\(P. 160\)](#).

- CMYK (also referred to as process colors)



- Set the density of the original image data as an integer value.

- Gradation

For more information on precautions, refer to "Precautions when replacing gradation colors"(P. 162).

Ink after replacement

The following colors can be set as the ink after replacement.

Ink color	Replaced with the printer ink color. The density can be set in a range 0% to 100%.
L*a*b* values	Replaces colors based on L* (lightness), a* (color space coordinates from red to green), and b* (color space coordinates from blue to yellow). L*a*b* values are color space coordinates that are independent of devices.



- The actual colors printed may differ from the colors set as ink colors and L*a*b* values depending on the conditions and environment such as the printing model and ink.



Linking with color collections

- Color collections are libraries containing color replacement information. For more information, refer to "Color Collection"(P. 226).
- If [Color Collection] is set to be used on the [Color Collection] window, colors will be replaced automatically if the conditions match when an image is imported. P. 227

● Precautions when replacing spot colors

Note the following points when spot colors are set within the original image data and those densities are altered before use.

- With RasterLink7, the ink density after replacement is set based on a spot color density of 100%. In the case of densities other than 100%, the ink density will be automatically calculated and set.

Example: When a spot color called [Spot] (display color C = 100, M = 0, Y = 0, K = 0) is applied at 100% in some areas and at 50% in others in Adobe Illustrator

- Replacing the spot color [Spot] with ink color densities C = 0, M = 80, Y = 20, and K = 0 in RasterLink7 prints with ink color densities C = 0, M = 80, Y = 20, and K = 0 for those parts in the original image data where [Spot] is applied at 100%.
Parts of the original image data where [Spot] is applied at 50% will be printed with ink densities automatically calculated, resulting in C = 0, M = 40, Y = 10, and K = 0.
- Enter the spot color name using single-byte alphanumeric characters. The following problems may result if any other characters are used:
 - Images cannot be imported to RasterLink7.
 - The spot color names may be displayed as garbled characters.
 - They may be output without color replacement even when color replacement has been set.

● Precautions when replacing colors in white objects

The density must be set to a minimum of 1 % for objects subject to color replacement. Color replacement specifications for white objects such as those below may produce unintended color replacement results:

- Objects with C=0, M=0, Y=0, K=0

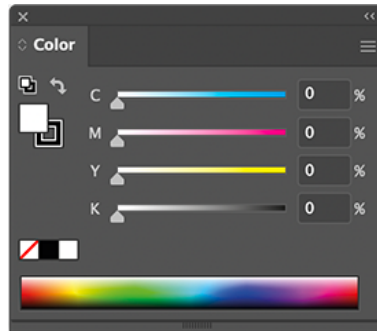

- Object with spot color density set to 0%

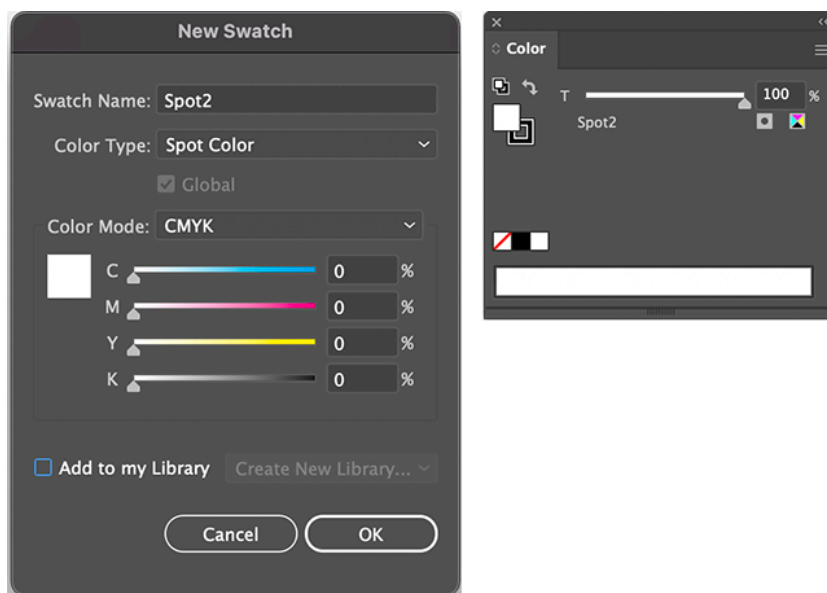

- Objects with spot colors of C=0, M=0, Y=0, and K=0

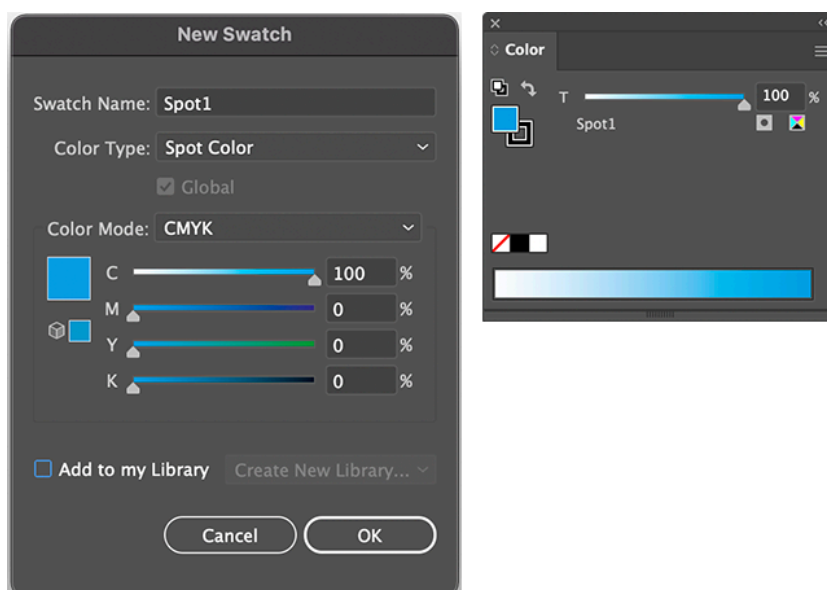

Method for setting spot color in Adobe Illustrator

- 1** Select [CMYK Color] for [Document Color Mode] in the Adobe Illustrator [File] menu.
 - This sets the image data color mode to [CMYK].
- 2** Select [Swatch] in the [Window] menu.
 - The [Swatch] window appears.
- 3** Click the icon at the top right of the window, then select [New Swatch] in the menu displayed.
 - The [New Swatch] window opens.
- 4** Configure the following settings.

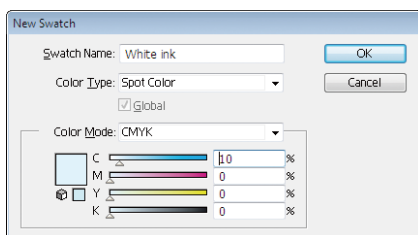

- | | | |
|--------------|---|--|
| [Name] | : | Enter the spot color name. |
| [Color Type] | : | Select [Special Color]. |
| [Color Mode] | : | Select [CMYK]. |
| [Color] | : | Set the display color.
Printing uses this color if color replacement is not used. |

- 5** Click [OK].
 - The spot color is registered in the list on the [Swatch] window.

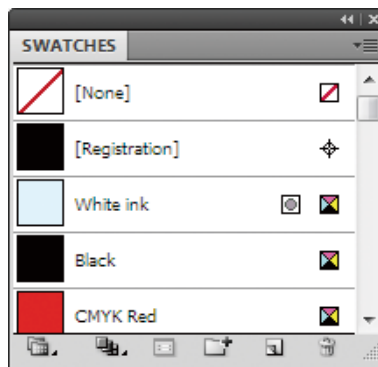

- 6** Create an object.
- 7** Select the object.
- 8** Select [Line] or [Paint] on the [Color] window.
- 9** Select a registered spot color on the [Swatch] window.
 - The spot color is applied to the object.

- 10** Save the data in a format allowing it to be imported into RasterLink7.

- **Precautions when replacing gradation colors**

Color replacement is possible only with the following four types of gradation.

Set the gradation within the range defined by the maximum and minimum densities.

Type	Maximum density (%)				Minimum density (%)			
	C	M	Y	K	C	M	Y	K
Cyan	100	1	1	1	0	1	1	1
Magenta	1	100	1	1	1	0	1	1
Yellow	1	1	100	1	1	1	0	1
Black	1	1	1	100	1	1	1	0



- Color replacement is not possible if a midpoint has been set and the color has been changed between the maximum and minimum densities of a gradation.
- Color replacement may not be performed correctly on gradations that include a large number of clipping passes.
- Illustrations containing the same colors as included in the gradation will also be color replaced.

Example: Maximum density C = 100, M = 1, Y = 1, K = 1

Minimum density C = 0, M = 1, Y = 1, K = 1

If the data includes an illustration with C = 50, M = 1, Y = 1, and K = 1, the illustration (vector data) color will also be replaced.

- Depending on the original image data, colors may not necessarily be correctly replaced even if gradation replacement settings are enabled on the [Color Replacement] screen.
Always make a reduced-size print to confirm that color replacement has been performed correctly.

For more information on original image data conditions that allow color replacement, also refer to  "Conditions"(P. 159) in Color Replacement.

Method for setting gradations in Adobe Illustrator

- 1** Select [CMYK Color] for [Document Color Mode] in the Adobe Illustrator [File] menu.
 - This sets the image data color mode to CMYK.
- 2** Create an object.
- 3** Select the object.
- 4** Select [Gradation] in the [Illustration] menu.
 - The [Gradation] window appears.

5 Set the maximum and minimum density.

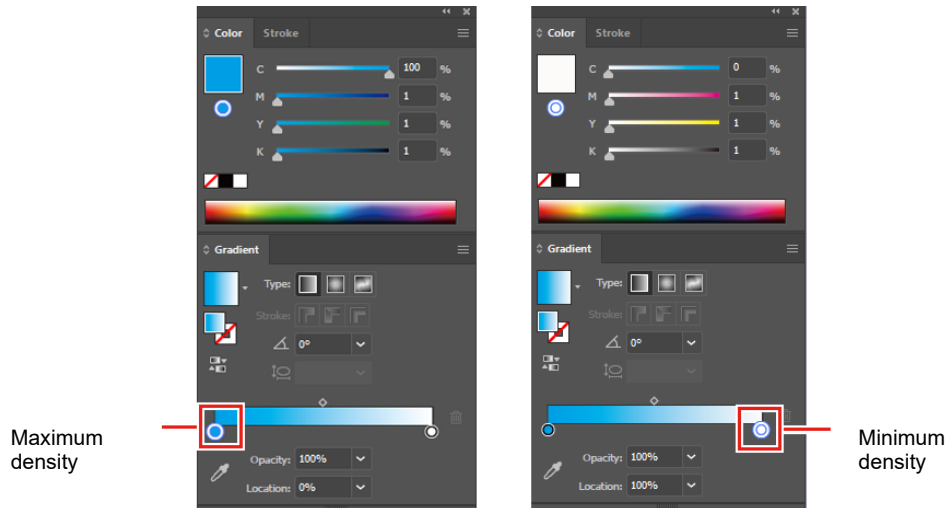

6 Save the data in a format allowing it to be imported into RasterLink7.

● Color replacement of a spot color used in a gradation

Color replacement of a spot color used in a gradation must satisfy either of the following conditions:

1. A PDF file
2. An image file created in Adobe Illustrator with [Compatible Gradation and Gradient Mesh Printing] disabled in the [Print] menu or the EPS options.

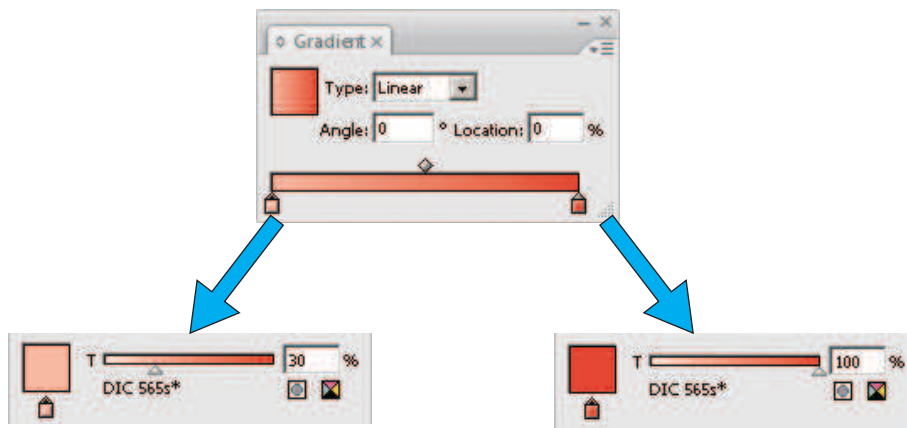

- If different spot colors are specified in a gradation

Color replacement may not be possible if multiple spot colors are specified for a single gradation object in an EPS file.

Try after resaving as a PDF file.

- Important!** • Operation is not guaranteed even for PDF files.

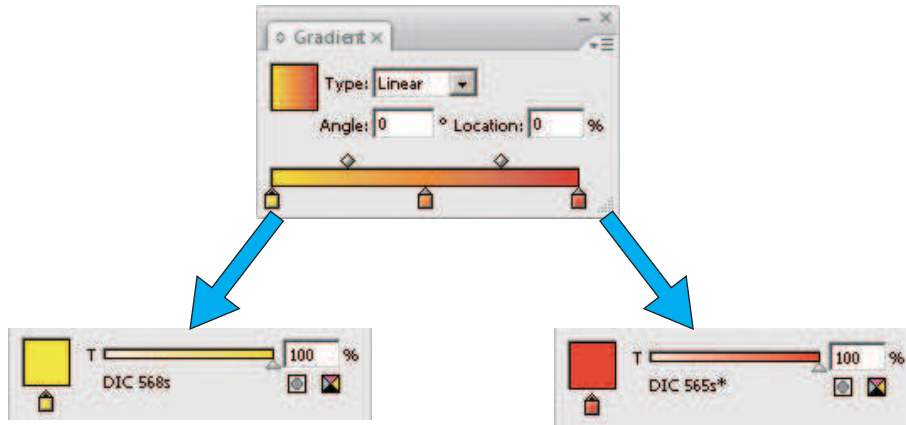

Color Replacement - Screen Layout

● [Color Replacement] screen

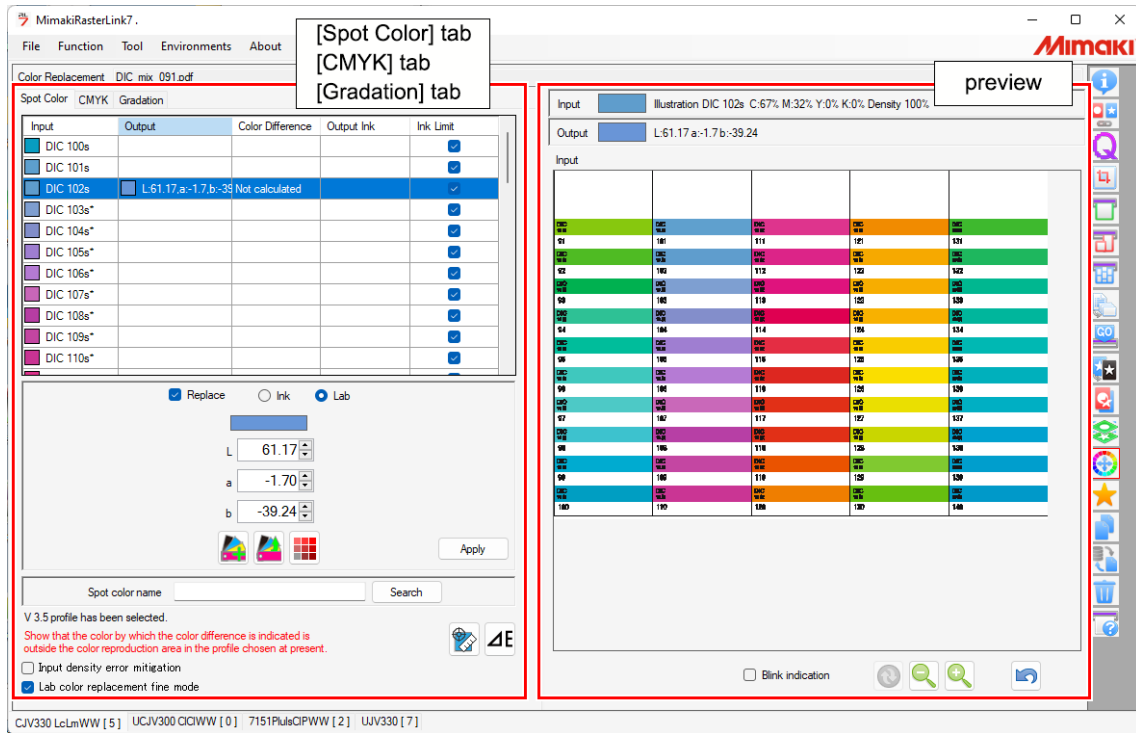

● [Spot Color] tab, [CMYK] tab, [Gradation] tab

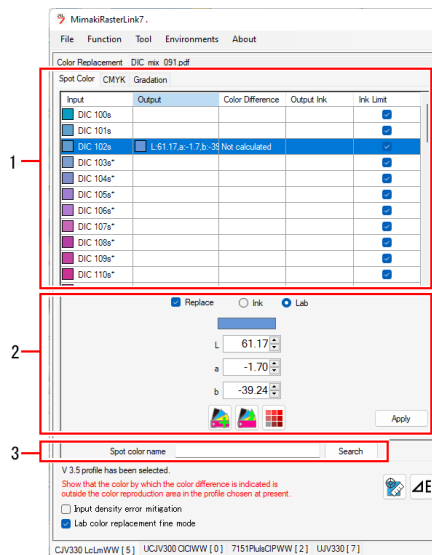

1. Input/output color list

Displays the color information for the original image data. Switching between the tabs switches to the list corresponding to the respective color type that can be replaced.

2. Ink after replacement

Sets the color after replacement.

3. [Spot color name] search

Searches for the spot color name displayed in the Input/output color list.

● [Spot Color] tab

Input	Output	Color Differe...	Output Ink	Ink Limit
DIC 9s	L:88.71,a:0.3			<input checked="" type="checkbox"/>
DIC 8s	L:85.78,a:9.3			<input checked="" type="checkbox"/>
DIC 7s	L:82.71,a:17.5			<input checked="" type="checkbox"/>
DIC 6s*	L:79.54,a:26.6			<input checked="" type="checkbox"/>
DIC 5s*	L:80.68,a:24.8			<input checked="" type="checkbox"/>

[Input] : Displays the spot color name and preview color.

[Output] : Displays the color after replacement and the simulated printed color.

[Ink Limit] : When printing, the check box will be displayed as selected when using the ink limit for the device profile.

- If [Ink after replacement] is [Ink], whether or not this is used can be set in the [Ink after replacement] box.
- If [Ink after replacement] is [Lab], this will always be displayed as selected.



- If a v3.5 or later device profile has been selected, the following information can be displayed by clicking the icon.
Color difference: Displays the color difference calculated from the following two L*a*b* values.
(1) Output L*a*b* values
(2) L*a*b* values calculated from the device profile selected from the [Print Condition] screen.
- Note, however, that the color difference will not be displayed when the output L*a*b* values are within the color reproduction range of the selected device profile.
The ink for output will also be displayed if a L*a*b* values are set in [Output Ink] [Output].

● [CMYK] tab

Input	Output	Color Differen...	Output Ink	Ink Limit
C:0,M:10,Y:90,K				<input checked="" type="checkbox"/>
C:80,M:20,Y:0,K				<input checked="" type="checkbox"/>
C:20,M:100,Y:4				<input checked="" type="checkbox"/>
C:100,M:100,Y:				<input checked="" type="checkbox"/>
C:0,M:0,Y:0,K:0				<input checked="" type="checkbox"/>
C:100,M:40,Y:0				<input checked="" type="checkbox"/>

[Input]: Displays the CMYK component values and preview colors.

[Output]: Displays the color after replacement and the simulated printed color.

[Ink Limit]: Selecting this applies the ink limit inside the device profile.



- If the [Color Difference] and [Output Ink] columns have Lab values for the color after replacement in the same way as on the [Spot Color] tab, this is displayed by clicking the icon.

● [Gradation] tab

Input	Output(Lower Limit)	Output(Upper Limit)
Black		
Magenta		
Cyan		
Yellow		

[Input]: Displays the gradation type. P. 162

[Output (Lower Limit)]: Displays the lower limit for the gradation after replacement.

[Output (Upper Limit)]: Displays the upper limit for the gradation after replacement.

● Preview



1. Color information

Displays color information for the location clicked on the preview.

[Input]: Displays information on the object, color mode, and original image data color.

[Output]: Displays the color after replacement.



- If there are locations where color replacement was not possible, click the corresponding locations on the preview. This allows you to check whether or not replacement is possible from the [Input] information.

2. [Display selected color in negative]

Selecting this check box inverts the color of parts selected in the Input/output color list on the [Spot Color] tab, [CMYK] tab, or [Gradation] tab.











Color Replacement - Operations

● Replace a spot color or CMYK

(Important!)

- For more information on original image data settings, refer to  "Precautions when replacing spot colors"(P. 160).

- 1 Select the job for color replacement on the [Job List] tab.
- 2 Click [Color Replacement] in the [Function] menu or the [Color Replacement] function icon ()
- 3 Select the [Spot Color] tab or [CMYK] tab on the [Color Replacement] screen.
 - The spot color or CMYK process colors used in the image data are displayed.

Input	Output	Color Differ...	Output Ink	Ink Limit
 DIC 2008s*	 L:82.7,a:18.47,Not calculated			<input checked="" type="checkbox"/>
 DIC 2008s*	 L:79.79,a:9.4,Not calculated			<input checked="" type="checkbox"/>
 DIC 2007s	 L:79.41,a:25.6,Not calculated			<input checked="" type="checkbox"/>
 DIC 2006s*	 L:78.12,a:51.8,Not calculated			<input checked="" type="checkbox"/>
 DIC 2005s*	 L:78.81,a:27.3,Not calculated			<input checked="" type="checkbox"/>

- 4 Select the spot color or CMYK process color you wish to replace from the list.
- 5 Select the [Replace] check box for [Ink after replacement].
- 6 Select [Ink] or [Lab].

7 Sets the color after replacement.

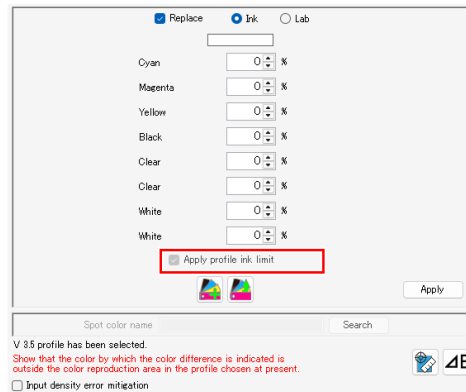
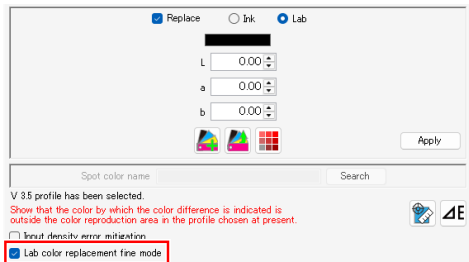

- Set the percentage if [Ink] is selected, and set the L*a*b* values if [Lab] is selected.



About [Apply profile ink limit]

- This is displayed when [Ink] is selected.
- Enabling this applies the device profile ink limit.
- The setting is automatically converted to a lower value to minimize ink overflowing when printing. (Even if set to 100%, a lower value is used for printing.)
- When not selected, printing uses the color component values as set, but this increases the possibility of printing defects such as bleeding due to ink overflowing. Where possible, this setting should normally be selected.
- It is automatically enabled if the special color inkset uses three or more slots.



About [Lab color replacement fine mode]

- This mode is displayed when [Lab] is selected with a profile of V3.5 or later selected.
- When turned on, the resolution of numerical values is higher than Ver. 3.1.0 or earlier, and more detailed numerical values can be specified.



About [Input density error mitigation]

- Enabling this relaxes the detection error for input density compared to when it is not used, extending the range for color replacement.
Try enabling this if the intended area is not included within the color replacement area.
Example: In cases where color replacement was set for an input density of Cyan 50%, but an area with Cyan 49.5% was not replaced.

8 Click [Apply].



- If color replacement is performed using color ink and special color ink at the same time, printing will be as follows depending on the special color overlay printing settings  "Layer - Operations"(P. 156) in the printer and layer settings.
- Special Color Over Print not used: The special color and color will be printed simultaneously. The special color ink and color ink will appear to intermix.
Color ⇒ Special color: The color ink will be printed first, then overprinted with the special color.
Special color ⇒ Color: The special color ink will be printed first, then overprinted with the color.
- If color replacement is performed using different special color inks at the same time, the results will differ depending on the particular model and settings.

● Replace a gradation color

- Important!** • For more information on original image data settings, refer to "Precautions when replacing gradation colors"(P. 162) and "Precautions when replacing spot colors"(P. 160).

- 1 Select the job for color replacement on the [Job List] tab.
- 2 Click [Color Replacement] in the [Function] menu or the [Color Replacement] function icon
- 3 Select the [Gradation] tab on the [Color Replacement] screen.
 - The gradations used in the original image data are displayed.

Input	Output(Lower Limit)	Output(Upper Limit)
Black		
Magenta		
Cyan		
Yellow		

- 4 Select the gradation you wish to replace with a different color.
- 5 Select the [Replace] check box for Ink after replacement.

Replace

Output(Lower Limit)

Cyan 10 %

Magenta 0 %

Yellow 0 %

Black 0 %

Clear 0 %

Clear 0 %

White 0 %

White 0 %

Output(Upper Limit)

Cyan 100 %

Magenta 0 %

Yellow 100 %

Black 0 %

Clear 0 %

Clear 0 %

White 0 %

White 0 %

V 3.5 profile has been selected.

Input density error mitigation

Apply

- 6 [Output (Lower Limit)]: Sets the minimum density for the gradation after color replacement.
- 7 [Output (Upper Limit)]: Sets the maximum density for the gradation after color replacement.
- 8 Click [Apply].



About [Input density error mitigation]

- Enabling this relaxes the detection error for input density compared to when it is not used, extending the range for color replacement. Try enabling this if the intended area is not included within the color replacement area. Example: In cases where color replacement was set for an input density of Cyan 50%, but an area with Cyan 49.5% was not replaced.

● Replace a color using a colorimeter

Important!

- If a v3.5 or later device profile has been selected on the [Print Condition] screen, a colorimeter can be used.

1 Click the icon.

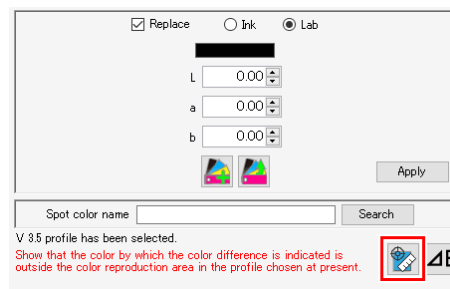

- The [Calibration] dialog appears.

2 Place the colorimeter on the white datum, then click [Next].

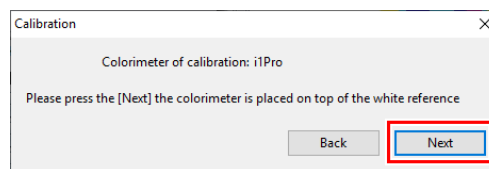

- The Spot Measurement screen appears once white datum measurement is complete.

3 Select the color to be measured from the list.

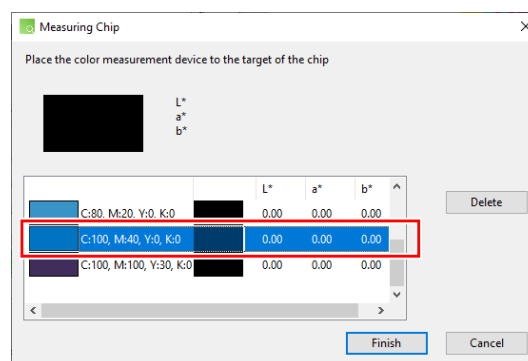

4 Hold the corresponding color against the colorimeter, then click the colorimeter button.

- The color measurement results (L*a*b* values) are displayed.
To continue and measure other colors, repeat steps (3) and (4).

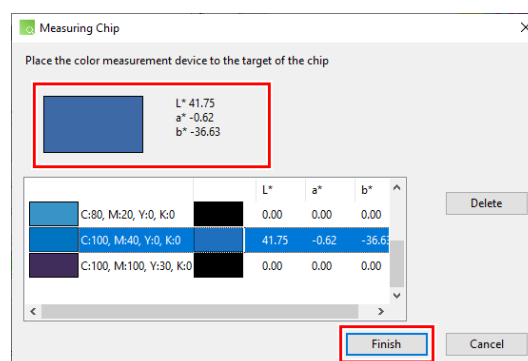







5 Click [Back].

- The measured L*a*b* values are displayed.





- If [Uncalculated] is displayed in the [Color Difference] column of the Input/output color list, click the  icon. The information for the color difference and output ink is calculated and displayed.

Spot Color	CMYK	Gradation		
Input	Output	Color Difference	Output Ink	
 C:0,M:10,Y:90,K:0				
 C:80,M:20,Y:0,K:0				
 C:20,M:100,Y:40,K:0				
 C:100,M:100,Y:30,K:0				
 C:0,M:0,Y:0,K:0				
 C:100,M:40,Y:0,K:0	 L:41.75,a=-0.62,b=3	Uncalculated		

● Select from a color collection

Select color replacement information from a color collection and apply it to a job.

- Select the job for color replacement on the [Job List] tab.
- Click [Color Replacement] in the [Function] menu or the [Color Replacement] function icon .
- Select the [Replace] check box for Ink after replacement.
- Click the  icon.
 - The [Import from Color Collection] dialog appears.

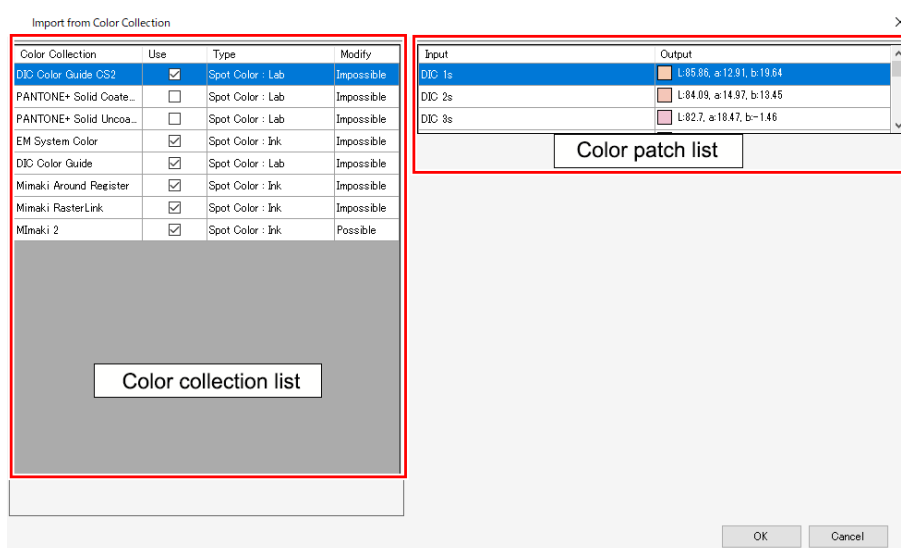

- Select the color collection to be used from the color collection list.
- Select the color to be set as the color after replacement from the color patch list.
- Click [OK].
 - [Output] is refreshed on the input/output color list.

● Register to a color collection

Register color replacement information to a color collection.

- 1 Select the colors for which color replacement is set in the input and output lists on the [Color Replacement] screen.
- 2 Click the  icon.
 - The [Export to Color Collection] dialog appears.

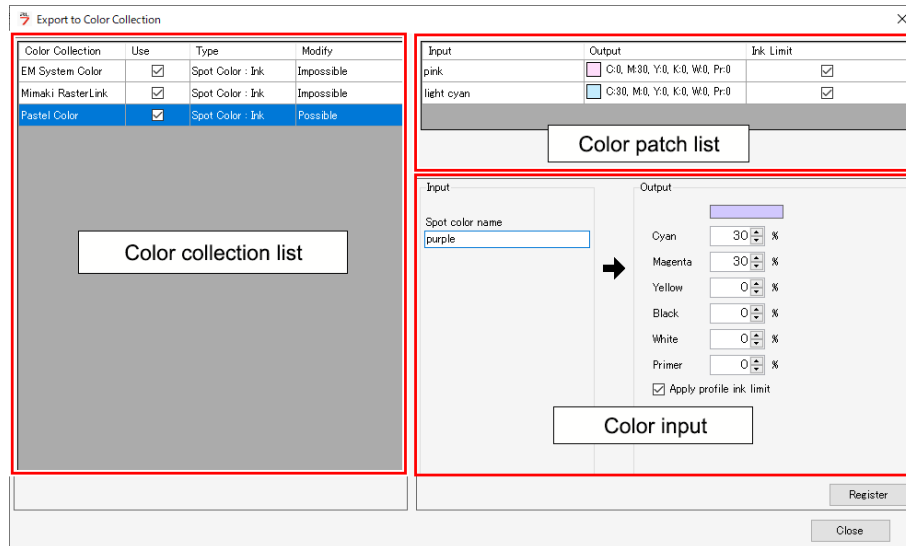

- 3 Select the color collection to be registered from the color collection list.
- 4 Check that the color information to be registered is set in the color input area.
- 5 Click [Register].
 - The color is registered in the color patch list.

Restrictions on the Color Replacement function

The Color Replacement function is restricted for the following models/ink sets.

- Models: UJF-6042MkII, UJF-6042MkIIe
- Ink set: CMYK+CIPWW

Restrictions are as follows.

- Color Replacement to primer is not available.
- Color Replacement to clear is not available.

For corresponding models/ink sets, use single color replacement or Special plate function.

If the image data input contains "ClearTexture" spot color name, uncheck the "Use" check box of the "Mimaki RasterLink" color collection before inputting the image data.

● Print a color chart based on the color after replacement

A Lab color chart can be created with the set color used as the base color if the color after replacement is Lab.

This is useful for adjusting the color after the color replaced image has been output.

For more information on Lab color charts, refer to  "Lab Color Chart"(P. 225).

- 1 Select the color to be replaced from the list.
- 2 Select the [Replace] check box for [Ink after replacement] if it is not already selected.
- 3 Select [Lab], then set the Lab after replacement.
- 4 Click the  icon.

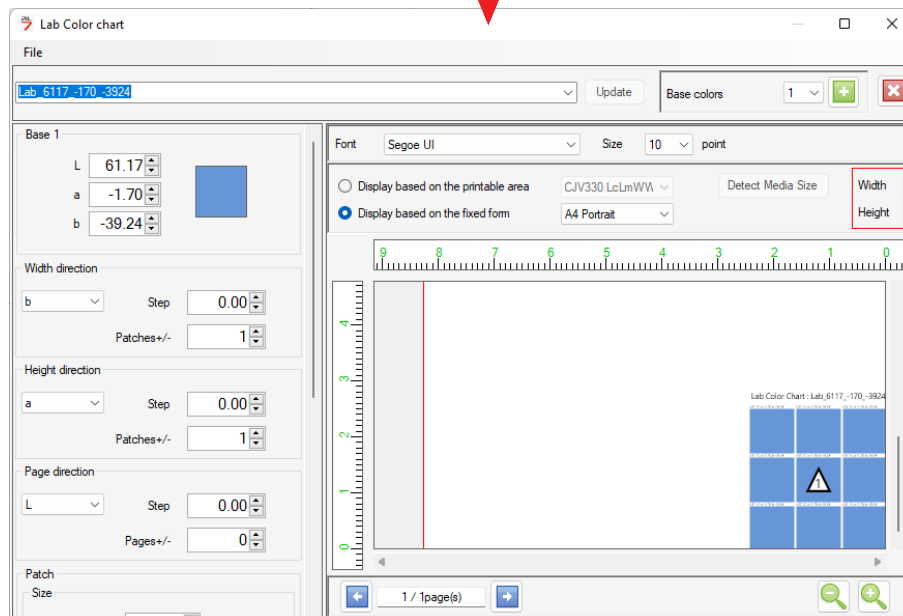
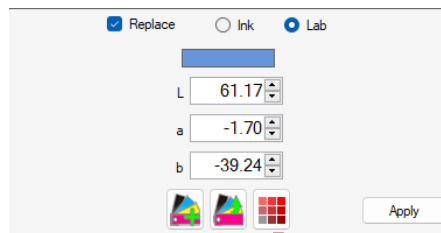

2.2.15 Favorite

Saves and manages the various function settings as a favorite.

Favorite Settings - Functions

RasterLink7 lets you save various settings as favorites. Settings saved (registered) as favorites can be applied to other print data.

The following conditions can be set as favorites for each function.

● [Properties]

- [Job Attribute]
- [Source color], [Ink]
Displayed when [Job Attribute] is set to [Mono Color].
- [UV Mode]



The UV Mode settings can be set as favorites in the case of the following jobs:

- Jobs for which [Job Attribute] is set to [Full Color] and a CMYK color or spot color has not been replaced with a special color
- Jobs for which [Job Attribute] is set to [Mono Color]

- [UV Mode] (Color Replacement)
UV mode for registering and using with jobs for which a CMYK color or spot color has been replaced with a special color
- [UV Mode] (Special plate)
UV mode for registering and using with jobs for which a special plate has been created or special plate jobs created automatically

For more information on how to set and apply, refer to ["Favorite Settings - Operations"\(P. 179\)](#).



Settings cannot be saved as favorites. Favorite settings cannot be applied with the following jobs:

- Jobs for which [Job Attribute] is set to [Cut Only] on the [Properties] screen
- Jobs for which the original image was in RGB color mode



The following items cannot be saved as favorites:

- [Properties] when [Attribute] in [Job List] is [Color (Glossy)]

● [Print Condition]

All of the conditions that can be set on the [Print Condition] screen

● [General Print]

- | | | |
|---------------|---------------------------|-------------------|
| • [Scale] | • [Rotation] | • [Mirror] |
| • [Deskew] | • [Arrange in the Center] | • [Register Mark] |
| • [Add Label] | • [Cut Edit] | |

● [Jig Print]

- | | | |
|----------------------|--------------|-----------|
| • [Jig Print ON/OFF] | • [Jig name] | • [Scale] |
| • [Rotation] | [Mirror] | |

- **[Tiling]**

- [Scale]
- [Overlap]
- [Add Label]
- [Rotation]
- [Tile number]
- [Mirror]
- [Cut line]

- **[Step & Repeat]**

- [Scale]
- [Arrange in the Center]
- [Reference Line]
- [Rotation]
- [Type]
- [Mirror]
- [Add Label]

- **[Jig Print]**

- [Kebab Print ON/OFF]
- [Mirror]
- [Scale]
- [Rotation]

- **[Special plate]**

- [Special plate]
- [Automatic Creation]
- [Special Color Print Area]
- [Execute]

- **[Layer]**

- [Layer setting for Special Color at Color Replace]
- [Position Correction]
- [Special color size correction]



Layer setting for Special Color at Color Replace]

Allows special color overprinting of image data when a special color has been used to replace another color to be registered as a favorite for each special color.

The following four types of special color overprinting can be registered:

- Special color→ Color
- Color→ Special color
- No color overprint
- Default (One of the above three types is registered as the default in accordance with the RasterLink7 program)

- **[Execute]**

- [Print Count]

Favorite Settings - Screen Layout

● [Favorite]

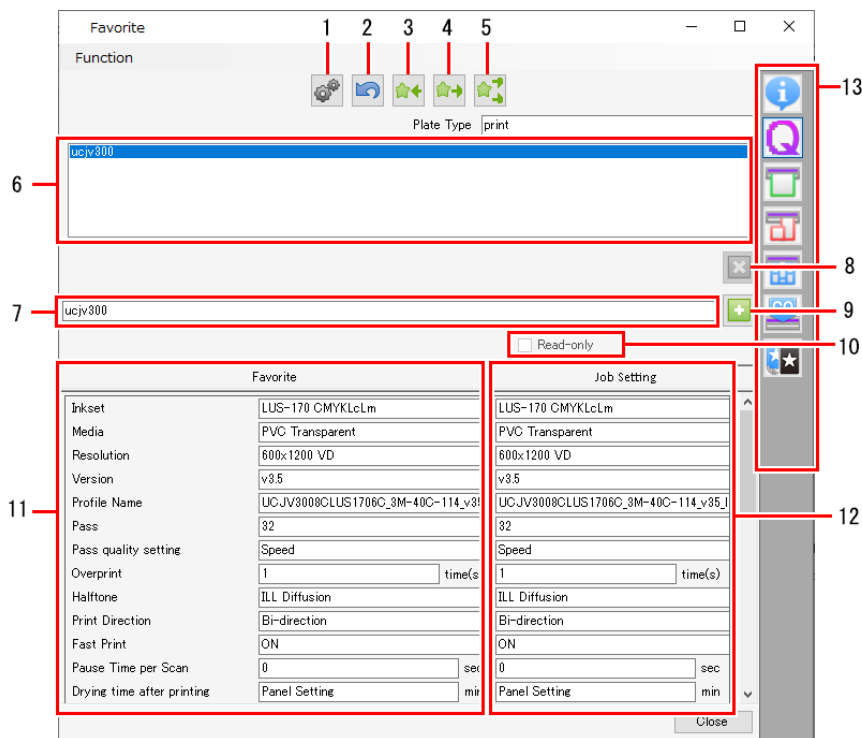

1	Create/delete hot folder	Creates and deletes hot folders and printer drivers.
2	Cancel	Cancels the last saved details.
3	Save	Saves the values displayed in [Job setting] as a favorite.
4	Apply	Applies the value for the selected function displayed in [Favorite] to [Job setting].
5	Apply all	Applies the values for all the functions displayed in [Favorite] to [Job setting].
6	List	Displays the favorites list.
7	Input box	Used to enter a name for a newly added favorite setting.
8	Delete	Deletes a favorite setting.
9	Add new favorite	Adds a new favorite setting.
10	Read-only	Check this box to set the selected favorite setting to read-only. This setting is used to prevent accidentally altering or deleting favorite settings.
11	Favorite	Displays the settings and values for the selected function set for a favorite.
12	Job setting	Displays the settings and values set for the job selected or currently being edited.
13	Function icons	Click on an icon to go to the favorites for the corresponding functions.

Favorite Settings - Operations

● Adding a new favorite setting

- 1** Click [Favorite] in the [Function] menu or the Favorite function icon.
- 2** Entering the name for the favorite setting in the input box.
- 3** Click the  icon.

- The new favorite setting is added to the favorites list.

Important!

- If a printer is registered, a favorite is created with the same name as the printer.
- The number of favorite sets that can be created is up to 100 for all printer settings registered in RasterLink7.

● Saving current settings as a favorite

- 1** Click a function to be edited from the [Function] menu or the corresponding function icon.
- 2** Configure the various settings.
- 3** Click [Favorite] in the [Function] menu or the Favorite function icon.
- 4** Select the destination favorite from the list.
 - The settings and values for the selected favorite are displayed in [Favorite].
- 5** Click the function icon in step 1.
- 6** Click the  icon.

- The job settings are saved in [Favorite] for the selected favorite.
- The settings and values set for the favorite are displayed.

● Calling up and applying favorite settings

- 1** Select the required job.
- 2** Click [Favorite] in the [Function] menu or the Favorite function icon.
- 3** Select the favorite to be applied from the list.
 - The settings and values for the favorite are displayed in [Favorite].
- 4** Click the function icon for the settings to be applied.
 - Check that the values in [Favorite] are correct.

5 Click the  icon.

- The settings and values displayed in [Favorite] are applied to [Job setting].



- Click the  icon to apply the contents of the selected favorite to all function settings, not just the function settings currently displayed.

● **Create a special color job automatically when an image is imported**

1 Create a special plate using the conditions to be used for automatic plate creation.

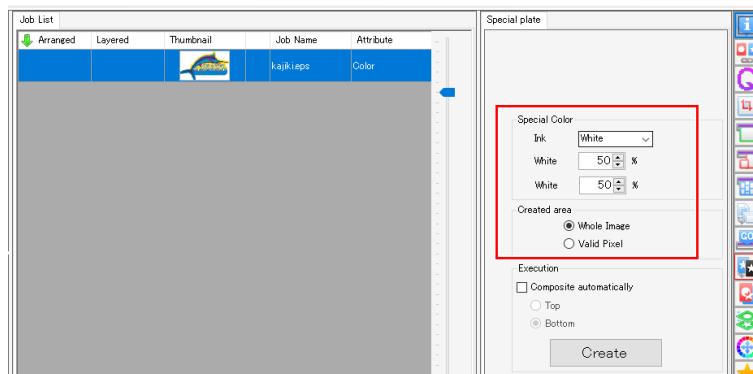

2 Select the special plate to be created on the [Job List] tab, then click the [Favorite] icon.

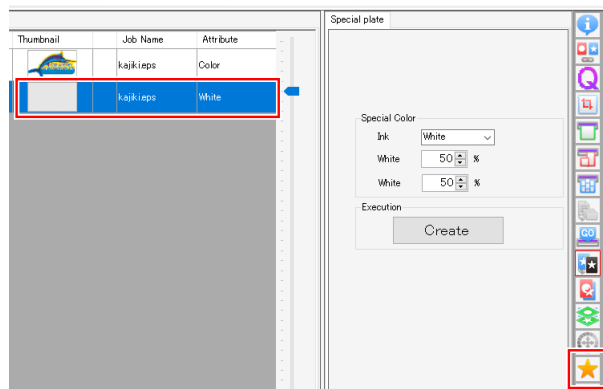

- The [Favorite] screen appears.

3 Create a new favorite.

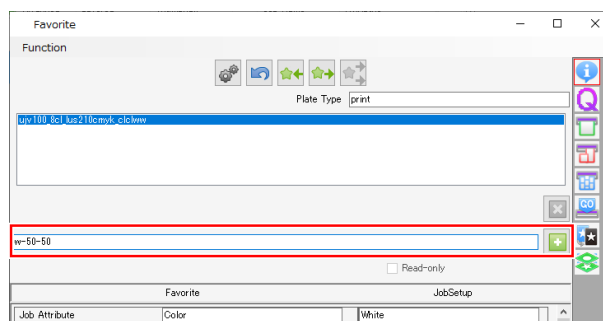

4 Click the [Special plate] icon on the [Favorite] screen.

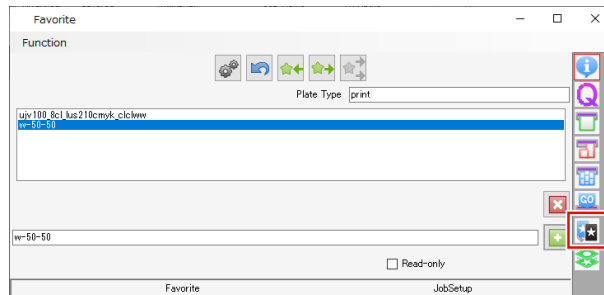

5 Click the [Save] icon to save the current conditions.

- The conditions ([Special plate] and [Special Color Print Area]) set for the job are saved as a favorite.

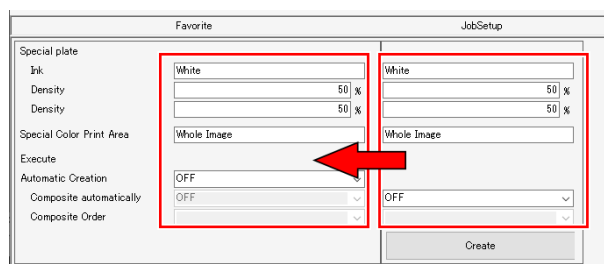

6 Enable [Automatic Creation].

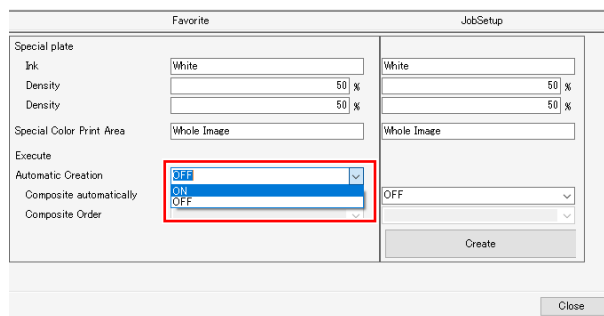

- If you wish to combine special plates created, set [Composite automatically] to [ON], then specify [Composition order].

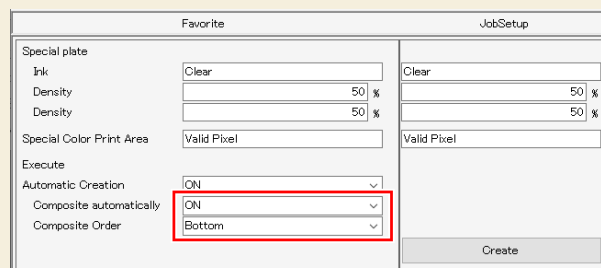

7 Select the favorite set, then import the image data "Favorite"(P. 176).

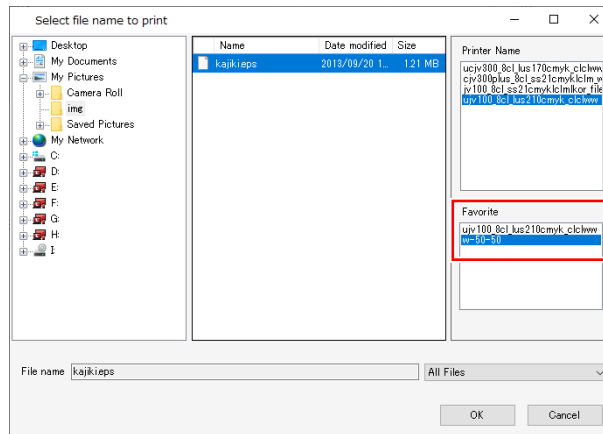

- A special color job will be created automatically based on the imported image data.

● Deleting favorite settings

1 Click [Favorite] in the [Function] menu or the Favorite function icon.

2 Select the favorite to be deleted from the list.

3 Click the  icon.

- The selected favorite will be deleted.
- Hot folders and printer drivers will be deleted.

Important!

- Favorites created when a printer was registered cannot be deleted.

● Creating a hot folder and printer driver from favorite settings

1 Click [Favorite] in the [Function] menu or the Favorite function icon.

2 Click [Create].

- A hot folder will be created.
- The hot folder will be created in the following location.
"RasterLink7 installation folder\Hot\Favorite name"

2.2.16 Duplicate

This is useful when you wish create a job similar to another job with only certain settings altered.

Duplicate - Functions

[Duplicate] allows the following operations.

- Duplicate a job

Duplicate - Screen Layout

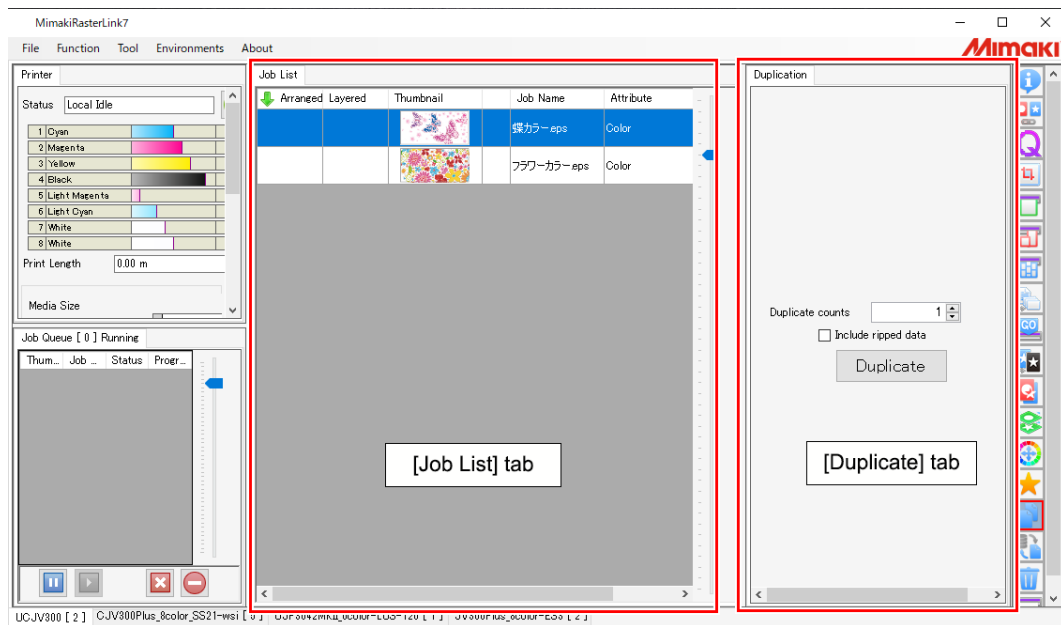

● [Duplicate] screen



Duplicate - Operations

● Duplicate a job

1 Select a job in the [Job List].

Job List				
Arranged	Lavered	Thumbnail	Job Name	Attribute
			Butterfly_p.eps	Color
			Flower_p.eps	Color

2 Enter the number of duplicates for the job in [Duplicate counts] on the [Duplicate] screen.

2	Duplicate counts	<input type="text" value="1"/>
3	<input type="checkbox"/>	Include ripped data
4	<input type="button" value="Duplicate"/>	

3 Select or deselect the [Include ripped data] check box.

- Selecting the check box duplicates both the job and ripped data.

4 Click [Duplicate].



- The duplicated job(s) will have the same name as the original job. The duplicated job(s) should be renamed appropriately on the [Properties] screen.  ["Rename a job"\(P. 34\)](#)

2.2.17 Backup

Creates a job backup file.

Restores a backed-up job from a file.

Backup - Functions

[Backup] allows the following operations.

- Back up jobs
- Restore jobs from backup files

● Conditions

Jobs cannot be restored from backup files in the following cases.

- With backup files for RasterLink6Plus or earlier



- The transfer tool should be used to transfer RasterLink6Plus backup files to RasterLink7. For more information, refer to the separate "RasterLink7 Transfer Tool Guide".

- When the printer or special color inkset registered in the backup file is not registered in the restore destination RasterLink7
- When the device profile or input profile specified in the backup file is not installed in the restore destination RasterLink7

Backup - Screen Layout

● [Backup] screen

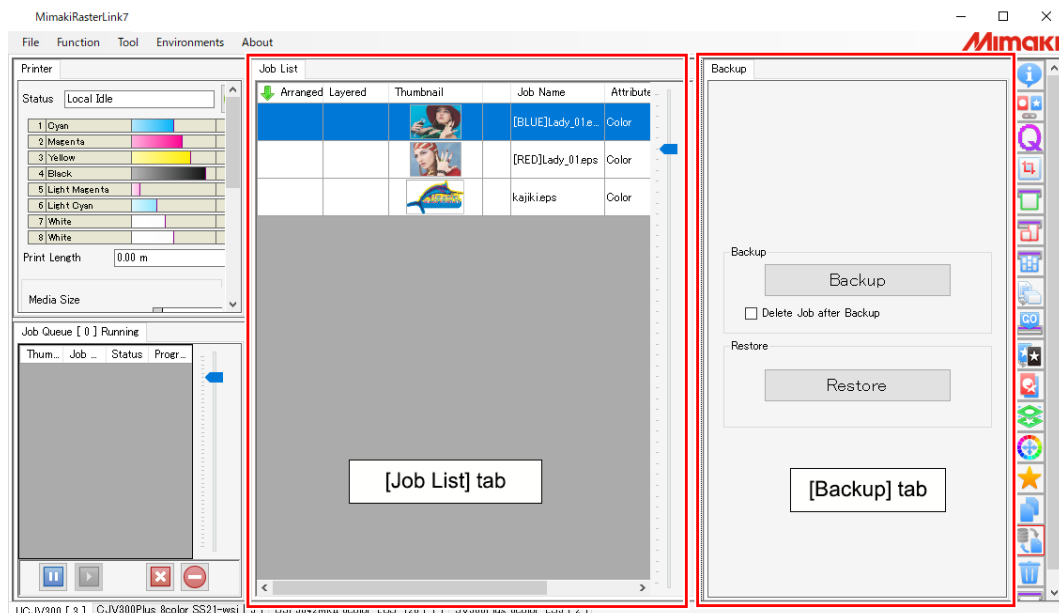

Backup - Operations

● Back up jobs

1 Select a job in the [Job List].

- If multiple jobs are selected, these will all be saved in a single backup file.

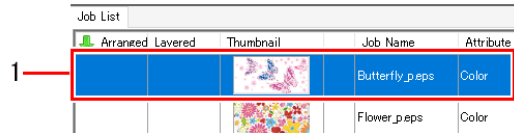

2 Select or deselect the [Delete Job after Backup] check box on the [Backup] tab.

- Selecting the check box deletes the job(s) after backing up.

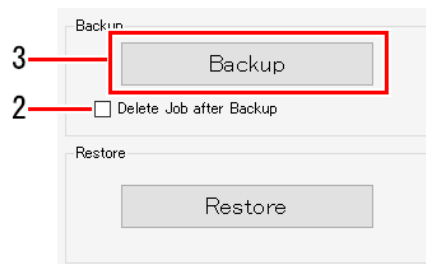

3 Click [Backup].

- The [Select file name to save] dialog appears.

4 Add a suitable name, then click [Save].

- A backup file is created.



Backup files save the following data.

- Original image data
- Job setting information
- Device profiles
- Input profiles
- Setting files

Important!

- Ripped data is not saved in backup files.
- Jobs should be ripped again if they have been restored from a backup file.

● Restore jobs from backup files

1 Click [Restore] on the [Backup] tab.

- The [Select backup file] dialog appears.

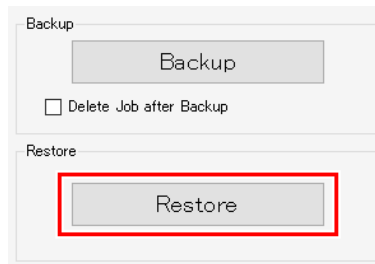

2 Select the file to be restored, then click [Open].

- The job is restored.

Important!

- When restoring jobs, an error message may appear indicating that a device profile or input profile is not installed. If this occurs, the device profile and input profile inside the backup file will be saved in "installation folder\Tmp". Details on the save destination are displayed in the message area.
- In such cases, restore using the following procedure.
 - (1) Exit RasterLink7.
 - (2) Launch [Profile Manager] from the Windows Start menu.
 - (3) Install the necessary device profiles and input profiles.
 - (4) Restart RasterLink7.
 - (5) Click [Restore] on the [Backup] tab.



- Jobs can also be restored from backup files by selecting [File] - [Restore].

2.2.18 Delete

Deletes a job.

Delete - Functions

[Delete] allows the following operations.

- Delete jobs and ripped data

● Conditions

Jobs cannot be deleted in the following cases.

- When only certain jobs in a group of jobs with [Composite] or [Arrange] set are selected



- An entire group of jobs can be deleted if all of the jobs with [Composite] or [Arrange] set are selected.
- Individual jobs can be deleted if [Composite] or [Arrange] is canceled.

Delete - Screen Layout

● [Delete] screen

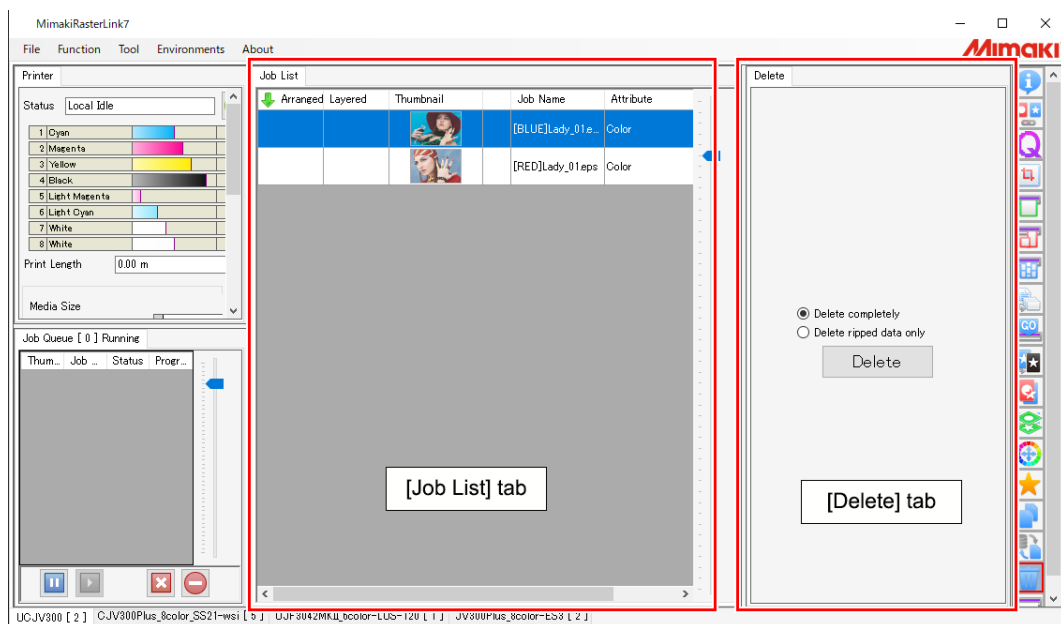



Delete - Operations

● Delete jobs and ripped data

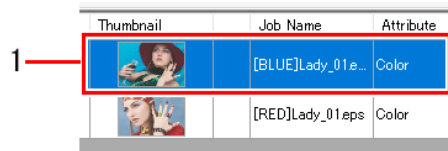
1 Select a job in the [Job List].



Thumbnail	Job Name	Attribute
	[BLUE]Lady_01.e...	Color
	[RED]Lady_01.eps	Color

2 Select the [Delete] tab items.

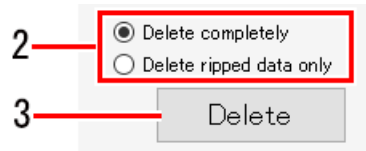

Delete completely
 Delete ripped data only

Delete

- [Delete completely]: Deletes all of the job information.
- [Delete ripped data only]: Deletes the ripped data for the selected job(s).

3 Click [Delete].

- The job and ripped data is deleted.

2.2.19 Jig Print

Positions the job on a jig before printing.



- Items that fix the print target (such as ballpoint pen or case) are referred to as "jigs".

Jig Print - Functions

[Jig Print] allows the following operations.

- Edit a jig template
- Print a jig outline
- Enlarge or reduce a jig print job
- Rotate a jig print job
- Reverse a jig print job
- Copy a jig print job
- Import and export a jig definition file

● Conditions

Compatible models

Flatbed printers, UJ330H

Editing conditions

Jig printing may not be available depending on the job settings.

Setting	Jig layout
[Composite]	Yes
[Arrange]	Yes
[Crop]	Yes
[Tiling]	No
[Step & Repeat]	No
[Lock the trimming position]	No
[Kebab Jig Print]	No
Yes: Jig printing possible No: Jig printing not possible	

Placing multiple jobs together in one jig

Configure the [Jig Print] settings after arranging multiple jobs.

Jig Print - Screen Layout

● [Jig Print] screen

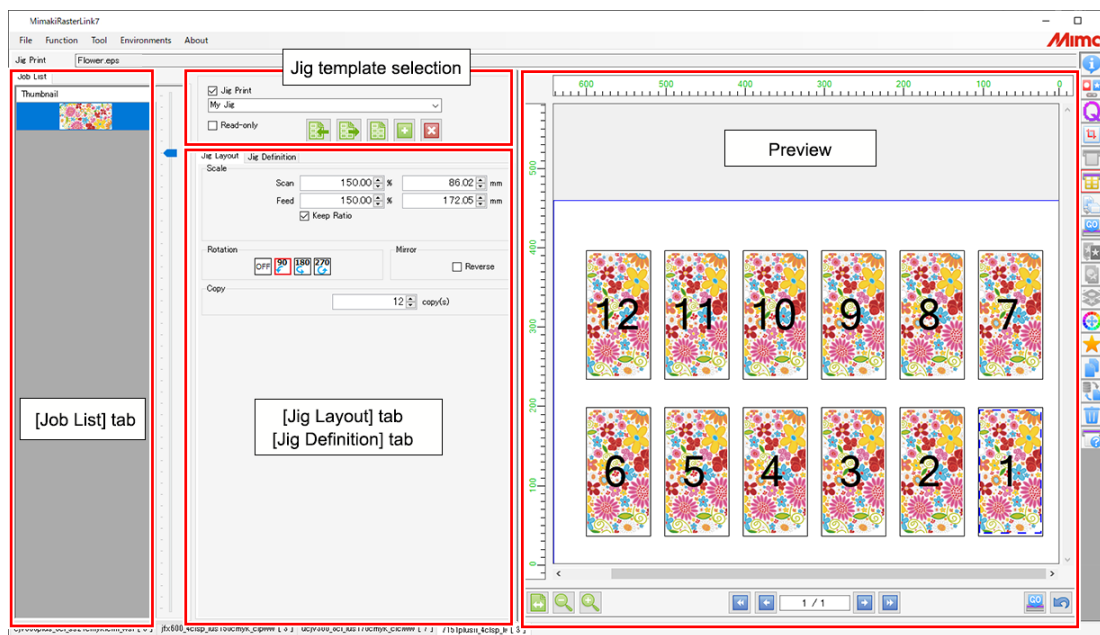





● [Job List] tab

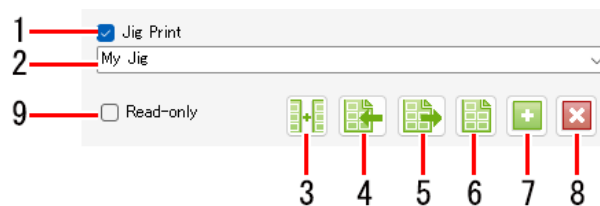

Displays the jobs to be edited in [Jig Print].

● Jig template selection



1. [Jig Print]
Select whether or not to use jig printing.
2. Jig template name
Select a jig template.
3.  Duplicate the jig in the scanning direction
Creates a new jig definition file by duplicating multiple materials within the jig definition file as a single group in the scanning direction.
For copied jigs, the values of [Size], [Counts], and [Interval] (Pitch) under [Material] cannot be changed.
4.  Import a jig definition file
Imports a jig template definition file to RasterLink7.
5.  Export a jig definition file
Saves a jig template definition file as an xml format file.
6.  Print jig outline
Prints a jig outline.

 For information on how to print the jig outline with the UJ330H, refer to the Important note (When using UJ330H) at the end of this description.

7.  Add jig template
Adds a new jig template.
8.  Delete jig template
Deletes a jig template.
9. [Read-only]
Selects whether jigs are read-only or can be edited.

Important! When using UJ330H

- Save the jig outline image as a PDF file for use. (The [Print] button on the [Print jig outline] screen cannot be used.)
- When loading a jig outline image into RasterLink7, enable [Rigid Media Editing] on the [Rigid Media Placement Printing] screen before printing.
- When printing without enabling [Rigid Media Editing], a margin equal to the standard right media margin (or the margin after it is applied if margins are set) will be added in the width direction.

● [Jig Layout] tab, [Jig Definition] tab, Preview

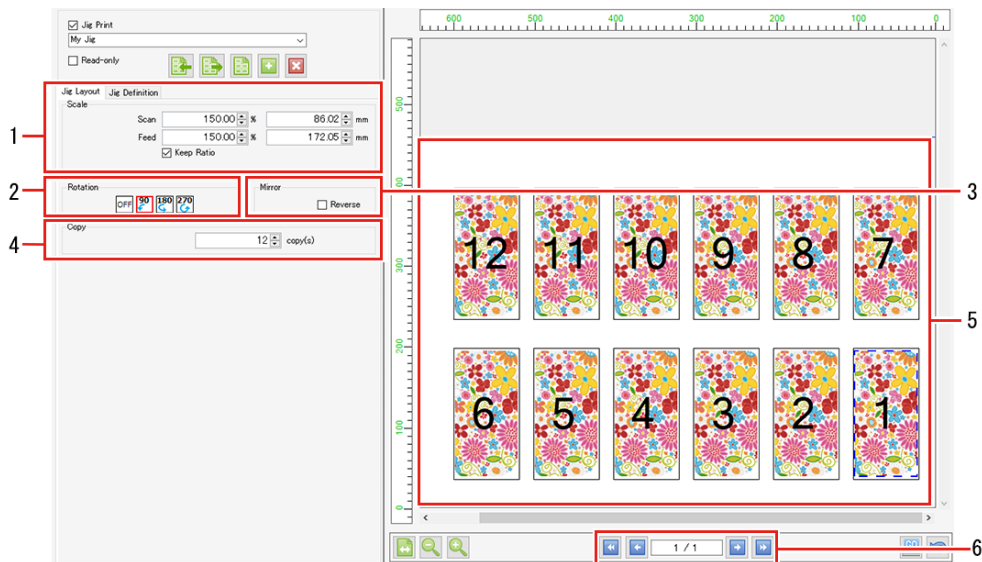

1. [Scale]
Sets the job size.
2. [Rotation]
Rotates the job.
3. [Mirror]
Reverses the job.
4. [Copy]
Sets the number of job copies.
5. Layout Preview
Displays the job positioned on the jig template.
6. Panel switching
Click  to switch the panel.

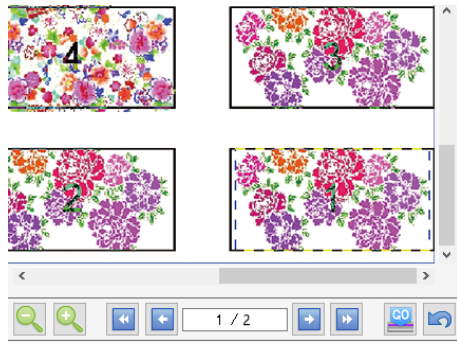

First panel (1/2)

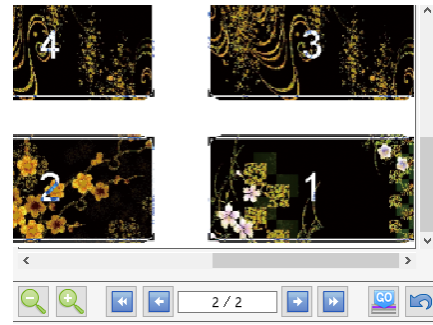

Next panel (2/2)

● [Jig Definition] tab

The screenshot shows the 'Jig Definition' dialog box with the following sections highlighted by numbered red boxes:

- 1. Size:** Width: 610.00 mm, Height: 420.00 mm
- 2. Position:** Width: 0.00 mm, Height: 0.00 mm
- 3. Deskew:** 0.00 degree
- 4. Material Size:** Width: 85.60 mm, Height: 54.00 mm
- 5. Counts:** Width: 6, Height: 6
- 6. Interval (Pitch):** Width: 98.00 mm, Height: 70.00 mm
- 7. First position:** Width: 17.20 mm, Height: 8.00 mm
- 8. Layout:** A 3x3 grid of squares, with the bottom-right square filled black.
- 9. Adjustment:** Material 1 (dropdown)
- 10. Skip:** Skip
- 11. Position:** Width: 0.00 mm, Height: 0.00 mm

1. [Size]

Sets the overall jig size.

2. [Position]

Sets the distance from the print origin position to the lower right of the jig.

3. [Deskew]

Sets the jig skew.

It cannot be used in combination with [Variable Edit].
[Deskew](#)

4. [Size]

Sets the size for one material.

5. Counts

Sets the number of materials to be positioned.

6. [Interval (Pitch)]

Sets the material spacing.

7. [First position]

Sets the distance from the lower right of the jig to the lower right of the first material.

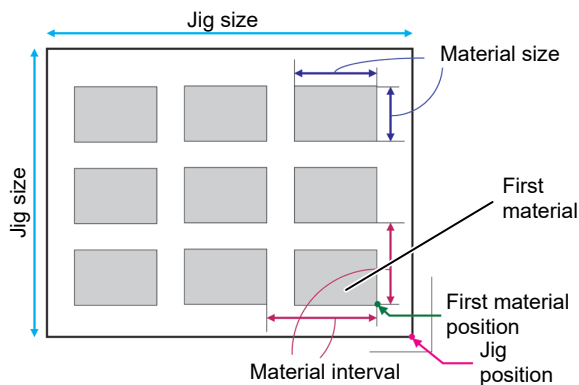

8. [Placement]

Sets the material position used as the reference for placing jobs.



9. [Material]

Selects the material to be adjusted.

10. [Skip]

Selects whether or not to include a material in printing.

11. [Position]

Adjusts the material position.

Jig Print - Operations

● Start jig printing setting

1 Select the [Jig Print] check box on the [Jig Print] screen.

- This allows the various [Jig Print] function settings to be edited.

● Edit a jig template

Create a new jig template



1 Enter the name of the new jig template to be set in the jig template selection input box.

2 Click the [] icon.

- The [Jig Definition] tab appears.

[Jig] : Sets the overall jig size, print origin position, and skew. Set the skew as the angle (-45° to 45°) with respect to the lower right of the jig.



- Skewing the jig also skews each material on the jig. Adjust the skew to correct tilt with respect to the table.
- Skewing jigs will cause job outlines and direct parts to become slightly jagged. Jagged edges will become particularly noticeable with low-resolution raster data. When skewing raster data, data should be created using a resolution close to the print resolution.

[Material] : Sets the individual material size, number, first material position, and placement. Size is set as valid print size (minimum 25.4 mm), count is set up to 99 x 99 (total 9,801), and interval is set as pitch (width is the distance from the right-hand edge of the right-hand material, and height is the distance from the bottom edge of the material below).

[Adjustment] : Selects a material and finely adjusts its position. Select using the material pull-down menu or click the material in the preview. The selected material is shown in the preview in a red box.

Edit a jig template

1 Select a jig template from the jig template selection pull-down menu.

2 Select the [Jig Definition] tab.

3 Click the [] icon after configuring the various jig settings.

- The jig template settings will be overwritten.



- The [Entire print area] jig template cannot be edited.

Delete a jig template

- 1 Select a jig template from the jig template selection pull-down menu.
- 2 Click the  icon.
 - The jig template will be deleted.

Important! • The [Entire print area] jig template cannot be deleted.

● Print a jig outline

- 1 Click the  icon.
 - The [Print jig outline] dialog appears.



[Favorite] : Selects the favorite used when printing an outline.

[Line Width] : Sets the outline width.

[Color] : Sets the outline color.

[Offset] : Sets the method for drawing the jig rectangle.

(The red box in the following figure indicates the jig rectangle, and the black lines indicate the outlines printed.)

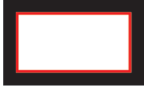
Offset	mm	Drawing setting	
Select	For 0	Prints an outline with the jig rectangle in the center of the lines.	
	Greater than 0	Prints an outline outside the jig rectangle.	
Half of line width	No setting	Prints an outline touching the jig rectangle on the outside.	

- 2 Click [Print].
 - The outline is printed.
- 3 Click [Save].
 - A PDF file is created.

● Enlarge or reduce a jig print job

- 1 Select the [Valid] check box in [Scale] on the [Jig Layout] tab.

2 Sets [Scan] and [Feed] for the job to be printed.

- [Scan] and [Feed] can be set as ratios (%) or size.
- If the [Keep aspect ratio] check box is selected, jobs can be enlarged or reduced while retaining the aspect ratio of the original image.

● Rotate a jig print job

1 Select the angle for counter-clockwise rotation in [Rotation] on the [Jig Layout] tab.

- With arranged jobs, the [Job List] thumbnails and settings for the jobs selected on the jig print preview screen are refreshed.

● Reverse a jig print job

1 Select the [Reverse] check box in [Mirror] on the [Jig Layout] tab.

- With arranged jobs, the [Job List] thumbnails and settings for the jobs selected on the jig print preview screen are refreshed.

● Copy a jig print job

1 Select the number of copies required using [Copy] on the [Jig Layout] tab.

- The job is copied and automatically positioned.
- With arranged jobs, the [Job List] thumbnails and settings for the jobs selected on the jig print preview screen are refreshed.

● Print

1 Click the icon in the preview.

- This starts ripping and printing using the same settings as the last time [Execute] was used. For more information on settings, refer to  "Execute"(P. 127).

● Use the jig barcode function



- For more information on the jig barcode function, refer to the separate "Jig Barcode Function Guide".

● Printing procedure using a jig

This example describes how to print on material with the dimensions shown in the following figure.

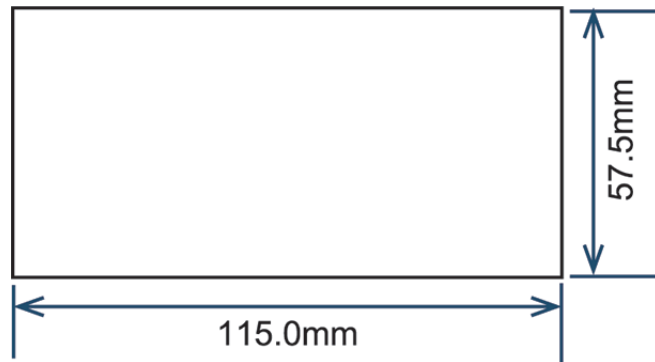

1 Register a new jig template.

- (1) Select the job to be printed, then click the [📄] icon to open the [Jig Print] screen.
- (2) Enter a suitable name for the jig template (here we use "MyJig"), then click the [➕] icon.
 - The display automatically switches to the [Jig Definition] tab.



2 Set the jig template.

- Enter the size information for the jig mounted on the printer.
The example here describes the procedure for the jig created and mounted with the following dimensions.
The numbers in the figure correspond to the step numbers shown after it.

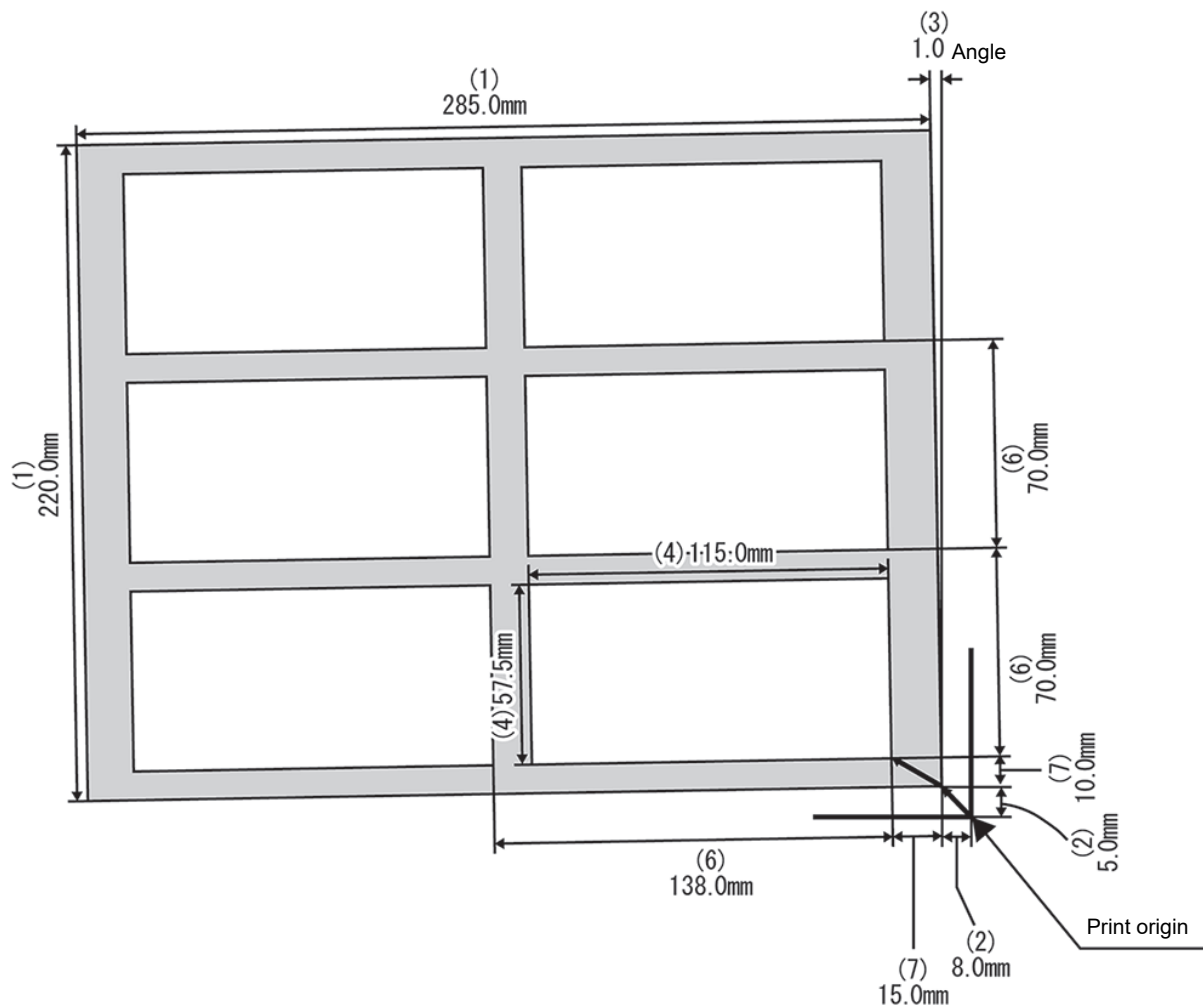

- (1) Enter the overall jig size.

Jig Size

Width mm

Height mm

- (2) Enter the distance from the print origin position to the lower right of the jig.

Position

Width mm

Height mm

- (3) Enter the angle for the jig skew with respect to the table. Enter positive values for counter-clockwise angles and negative values for clockwise angles.

Deskew

degree

- (4) Enter the material size.

Material Size

Width mm

Height mm

- (5) Enter the number of materials placed in the width and height directions respectively.

Counts

Width

Height

- (6) Enter the interval and pitch when laying out materials in rows.

Interval(Pitch)

Width mm

Height mm

- (7) Enter the distance from the lower right of the jig to the lower right of the material position.

First position

Width mm

Height mm

- (8) Select the job placement reference if the material size does not match the image size.

Layout

Important! When using UJ330H

- If the material position is defined within the print margin area (right edge or front edge), any images placed on that material will be cropped.
- Do not define the material position within the print margin area.

3 Positions the job on a jig.

- (1) Click the job [] icon to display the [Job List] tab.
- (2) Select the job to be printed, then open the [Jig Print] screen. The example here shows the procedure for selecting three arranged jobs.

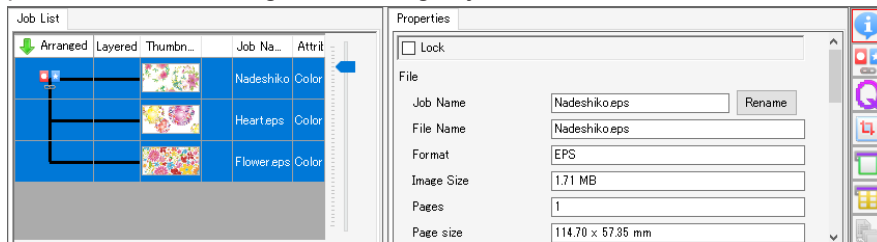

- (3) Select the jig template created (MyJig).
 - The jobs are placed in the preview one by one.

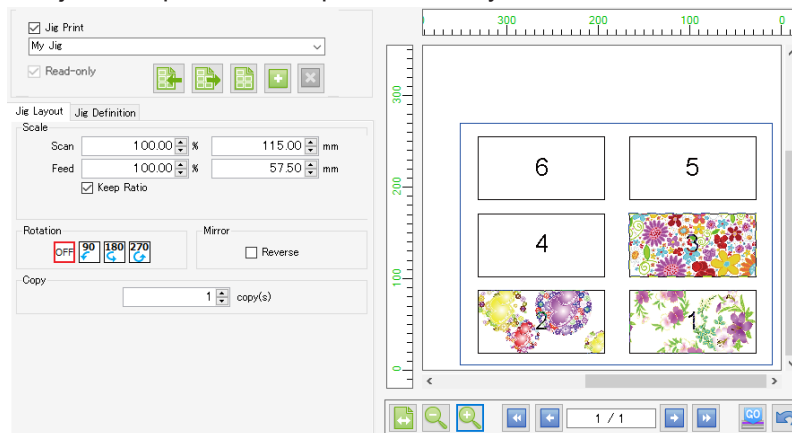

- (4) If each job is to be printed multiple times, select the job in the preview, then set the number of copies to be printed in [Copy]. Here we set two copies of each job to be printed.

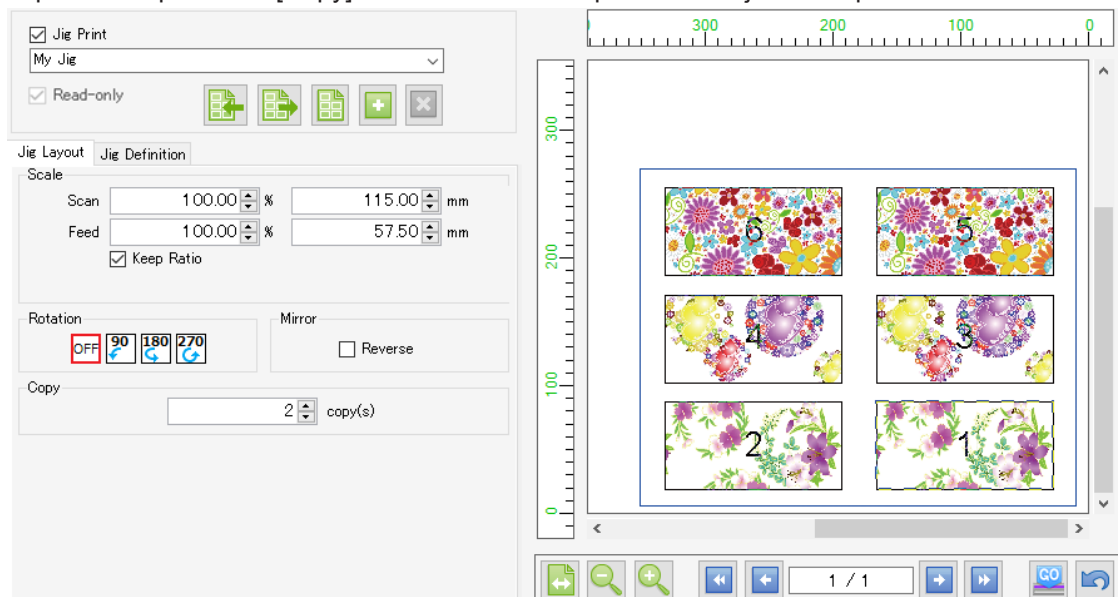

Important!

- [Jig Print] cannot be selected if multiple non-arranged jobs are selected. Depending on the conditions, some settings may not allow [Jig Print] to be selected. For more information, refer to  "[Conditions](#)"(P. 190).
- Placement proceeds from the upper jobs. If the printing sequence is important, note the sequence in which images are imported into RasterLink7.
(The order of the job list is determined automatically by the order in which images are imported. The job list cannot be reordered after images have been imported.)

4 Print.

Click the  icon below the preview to print.

● Corrective action when printing issues arise

When the print position is offset

If the print position is offset even when the previously set jig template is called up and printing is repeated, set [Adjustment] on the [Jig Definition] tab.

In the example described here, the third material position is offset.

1 Measure the amount of offset between printing and the material.

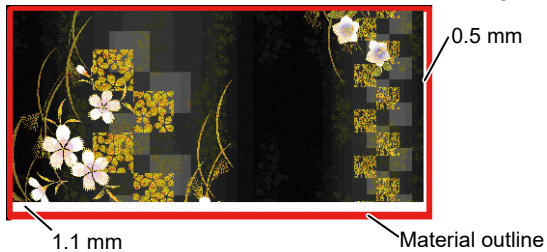

2 Opens the [Jig Print] screen.

3 Open the [Jig Definition] tab.

4 Select [Material 3] in [Adjustment], then enter [Width] and [Height] as shown below.

Adjustment	
Material 3	▼
<input type="checkbox"/> Skip	
Position	
Width	0.50 mm
Height	1.10 mm

5 Print again and check the position.

Print only a specific job when one material is not correctly printed (when copy is set with only one job)

1 Set the number of copies to the number of failed prints.

2 Print.

Print only a specific job when one material is not correctly printed (when using arrangement)

1 Cancel arrangement.

2 Repeat arrangement for only the job that was incorrectly printed.

3 Print.

● Import a jig definition file to RasterLink7

Import a jig definition file created as described in  "When exporting a jig definition file"(P. 204).

1 Click the (Import) icon.

- A file selection dialog appears.

2 Select the required jig definition file, then click [OK].

- The jig template set by the definition file will now be selected.



The selected jig definition file cannot be imported in the following cases:

- When a jig template with the same name already exists in RasterLink7
- When the selected definition file size exceeds the table size of the printer displayed in RasterLink7.
- When the exported jig definition file has been renamed

● When exporting a jig definition file

1 Select the jig template to be exported.

2 Click the (Export) icon.

- The file save dialog appears.

3 Add a suitable name, then click [Save].



- The name specified here will be used as the name of the jig template when the jig definition file is imported to RasterLink7.

2.2.20 Rigid Media Placement Printing

Place the job on rigid media and print.

Rigid Media Placement Printing - Functions

[Rigid Media Placement Printing] allows the following operations.

- Enter the height and width size of the rigid media
- Enter the count for the width direction of the rigid media
- Enlarges and reduces jobs
- Rotate jobs
- Reverse jobs
- Copy a job
- Crop a job
- Set the job placement position

● Conditions

Compatible models

UJ330H

Editing conditions

Rigid media placement printing may not be available depending on the job settings.

Setting	Rigid Media Placement
[Composite]	Yes
[Arrange]	Yes
[Crop]	Yes
[Tiling]	No
[Step & Repeat]	No
[PrintGroup]	No
YES: Rigid Media Placement Printing is available. NO: Rigid Media Placement Printing is not available.	

When multiple jobs need to be placed together on rigid media

Configure the Rigid Media Placement Printing settings after arranging multiple jobs.

Rigid Media Placement Printing - Screen Layout

● [Rigid Media Placement Editing] screen

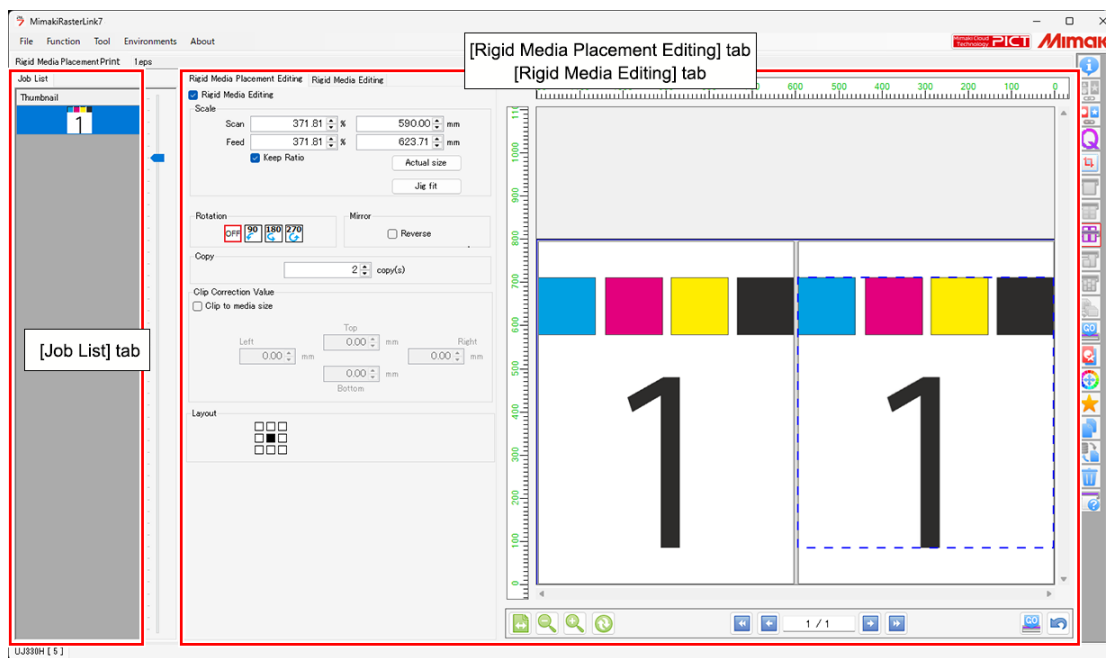



● [Job List] tab

Displays the jobs to be edited in [Rigid Media Placement Editing].

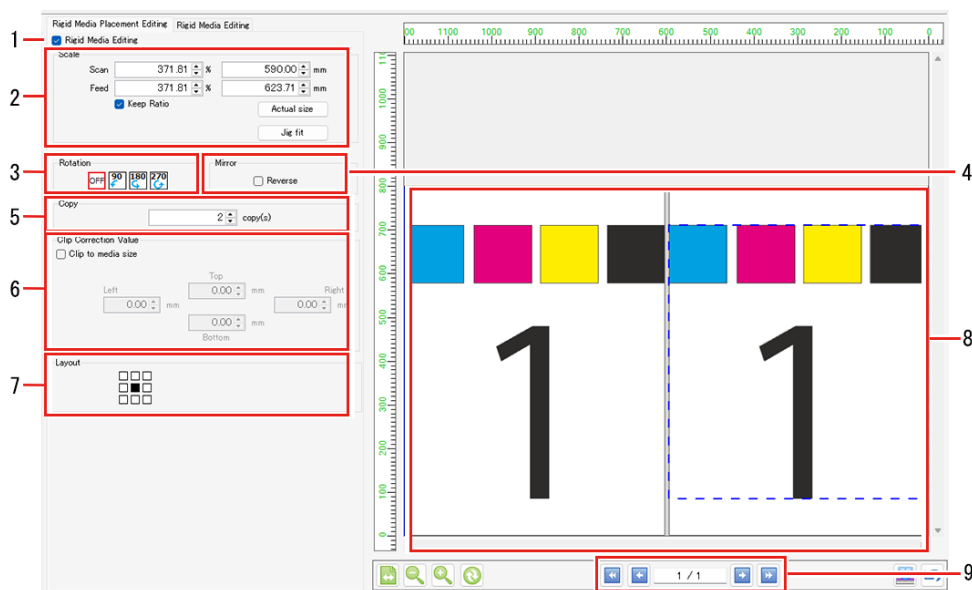
● [Rigid Media Placement Editing] Tab



1. [Rigid Media Editing]
Select whether to enable rigid media placement printing.
2. [Scale]
Sets the job size.
3. [Rotation]
Rotates the job.
4. [Mirror]
Reverses the job.

5. [Copy]
Sets the number of job copies.
6. [Clip Correction Value]
If Crop setting () are enabled, this function cannot be used.
Set the crop dimensions for the top, bottom, left, and right edges of the job.
7. [Placement]
Set the reference position for placing the job on the rigid media.
8. Layout Preview
Displays the state of jobs placed on rigid media.
9. Panel switching
Click  to switch the panel.

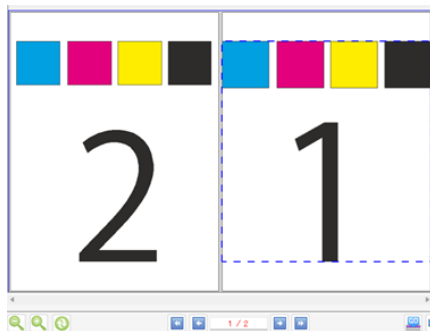

First panel (1/2)

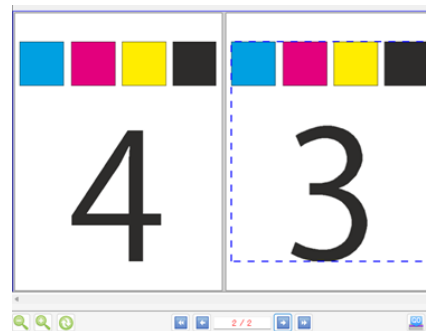

Next panel (2/2)

● [Rigid Media Editing] Tab

1. [PrintableArea]
Displays the actual printable size for the set rigid media.
 - Width
Rigid media width × width count - (Invalid print left width + right width)^{*1}
 - Length
Rigid media height - (Invalid print top height + bottom height)





*1) The display size includes the invalid printing area between rigid media.
2. [Size]
Enter the height and width size of the rigid media.
3. [Counts]
Enter the count for the width direction of the rigid media.



- When connected online to the printer itself, the size and count of rigid media set on the printer will be automatically applied.
Consequently, manually entering data is not necessary unless specifically required.

Rigid Media Placement Printing - Operations

Important!

- Set rigid media on the printer and specify the rigid media size and count in the width direction on the printer panel. (Refer to "Loading Rigid Media" in the Operation Manual of the printer.) When the rigid media placement print screen is displayed, the printer automatically acquires the rigid media information and applies it to the screen.
- If you re-set the rigid media on the printer, or change the size or number of items in the width direction while editing in the [Rigid Media Placement Printing] screen, be sure to click the  (reload) icon in the preview to retrieve the latest size and number of items in the width direction. If you print without clicking the  (reload) icon, the size or number of items in the width direction of the rigid media may not match, and printing may not be performed at the correct position.
- If no rigid media is loaded or if the printer is currently printing on rigid media, the printer cannot acquire rigid media information, so the following values are set as defaults on the screen.
Size: Width 102.33 mm, Length 430 mm
Count: 3 pcs
At that point, the  (update with exclamation mark) icon will be displayed. After inserting the rigid media, click the  (Update) icon, or enter the size and count manually.

1 Select the [Rigid Media Edit] check box on the [Rigid Media Placement Editing] Screen.

- Rigid media placement printing settings can now be configured.

● Enlarge or reduce the job

1 Sets [Scan] and [Feed] for the job to be printed.

- [Scan] and [Feed] can be set as ratios (%) or size.
- If the [Keep aspect ratio] check box is selected, jobs can be enlarged or reduced while retaining the aspect ratio of the original image.
- Clicks on the fit button will automatically enlarge or reduce the image to fit the rigid media size.

● Rotate jobs

1 Select the angle to rotate the print job counter-clockwise.

- With arranged jobs, the [Job List] thumbnails and settings for the jobs selected on the rigid media placement printing preview screen are refreshed.

● Reverse jobs

1 Select the [Mirror] check box in job to be printed.

- With arranged jobs, the [Job List] thumbnails and settings for the jobs selected on the rigid media placement printing preview screen are refreshed.

● Copy a job

1 Select the copy count for the print job to be copied.

- With arranged jobs, the [Job List] thumbnails and settings for the jobs selected on the rigid media placement printing preview screen are refreshed.

● Print

1 Click the  icon in the preview.

- RIP and printing will start using the same settings as the last [Execute] was used.
- For settings, refer to  "Execute"(P. 127).

● Reprint

1 Set the rigid media on the printer, then configure the media size and the number of items in the width direction. (Refer to "Loading Rigid Media" in the Operation Manual of the printer.)

2 Select the job to print, and click the  (Rigid Media Placement Printing) icon.

- The [Rigid Media Placement Printing] screen appears.
- If the [Rigid Media Placement Printing] screen is already open, click the  (reload) icon in the preview.

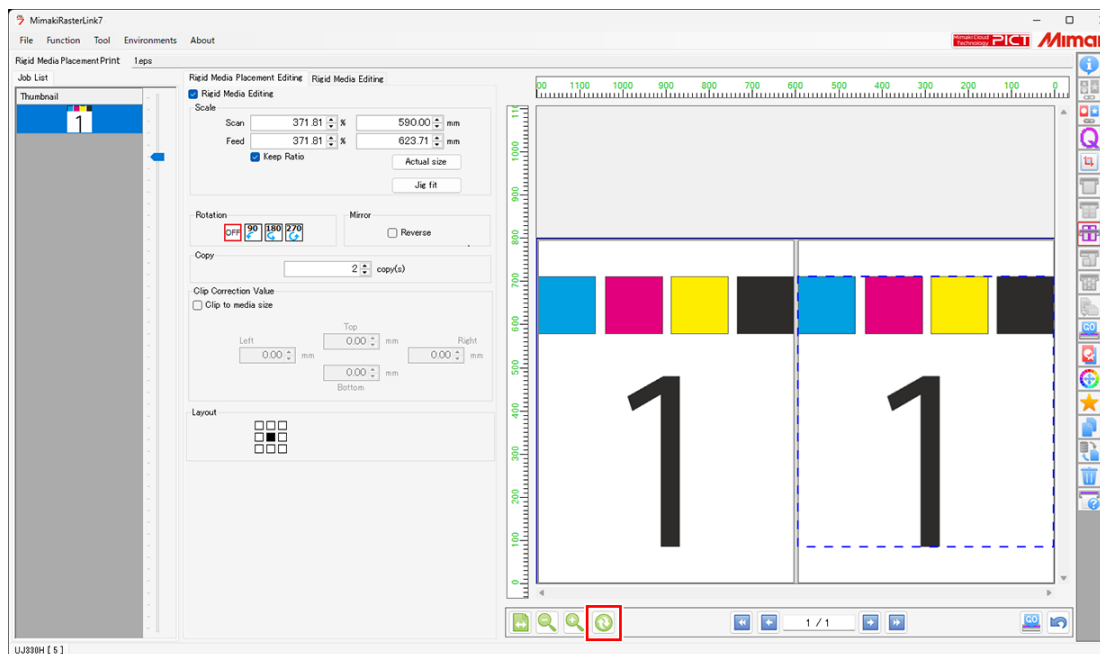

3 Configure each setting for the rigid media.

4 Starts printing.

2.3 Tool

This section explains the various color charts, color collections, and calibration.

Select from the [Tool] menu at the top of the main screen.

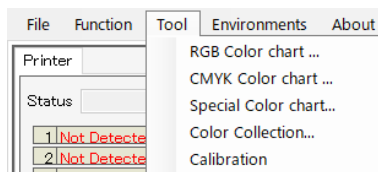

- In RasterLink7, "color charts" refer to color samples with varying color components centering around a base color.

2.3.1 RGB Color chart

The functions screen layout and operations for [RGB Color chart] are the same as for [CMYK Color chart].

[CMYK] in [CMYK Color chart] should be replaced with [RGB] when referring to the explanation.

2.3.2 CMYK Color chart

The CMYK color chart printed can be used to alter the colors of a CMYK image using design software before spooling to output the desired colors.

If a printed color differs from the intended color, creating a color chart focusing on that color makes it easier to identify the target color.

CMYK Color chart - Functions

[CMYK Color chart] allows the following operations.

- Add a color chart definition file
- Edit a color chart definition file
- Create a PDF from a color chart
- Import a color chart PDF as a job
- Delete a color chart definition file

CMYK Color chart - Screen Layout

[CMYK Color chart] screen

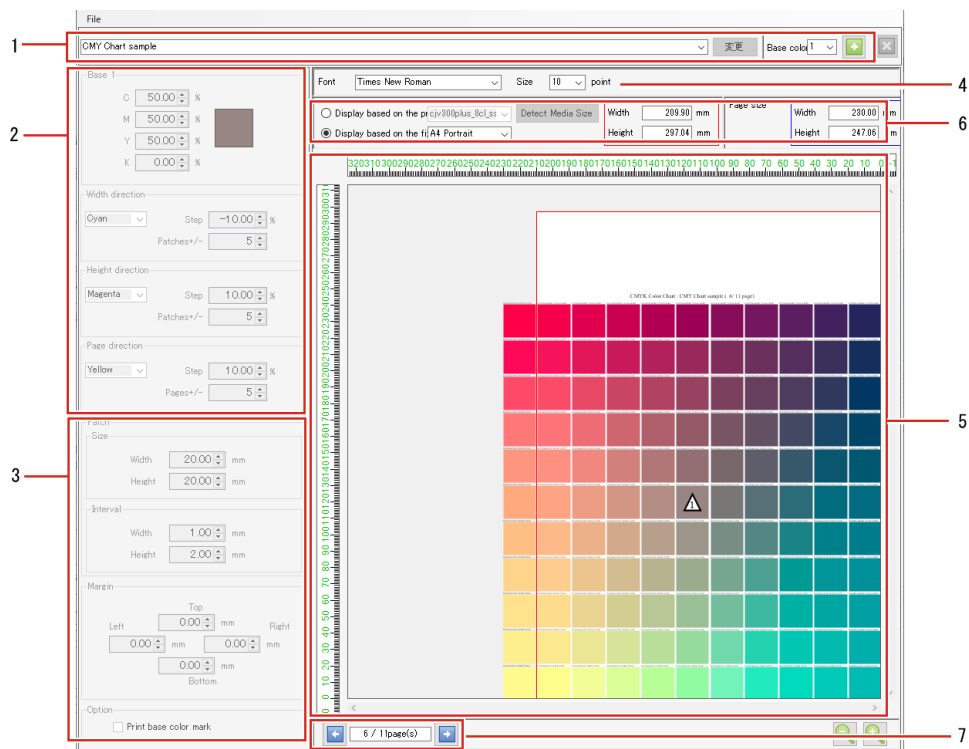

1. Color chart definition file

Adds, selects, deletes, and edits chart definition files.

2. Color settings

Sets the base color(s) and color component variations.

The number of base colors can be selected as 1, 2, or 4.

The details displayed will vary depending on the number of base colors.

With one base color

Base 1

C 50.00 %
 M 50.00 %
 Y 0.00 %
 K 0.00 %

Width direction
 Cyan Step 4.00 %
 Patches+/- 4

Height direction
 Magenta Step 5.00 %
 Patches+/- 4

Page direction
 Yellow Step 5.00 %
 Pages+/- 2

With two base colors

Base 1

C 60.00 %
 M 10.00 %
 Y 20.00 %
 K 0.00 %

Base 2

C 100.00 %
 M 100.00 %
 Y 0.00 %
 K 0.00 %

Width direction
 Base 1 3 Base 2

Height direction
 Magenta Step 10.00 %
 Patches+/- 1

Page direction
 Yellow Step 10.00 %
 Pages+/- 3

With four base colors

K 50.00 %

Base 2

C 100.00 %
 M 50.00 %
 Y 0.00 %
 K 0.00 %

Base 3

C 0.00 %
 M 50.00 %
 Y 50.00 %
 K 50.00 %

Base 4

C 0.00 %
 M 50.00 %
 Y 0.00 %
 K 0.00 %

Patches
 Base 3 3 Base 4
 Base 1 3 Base 2

Page direction
 Black Step 10.00 %
 Pages+/- 5

3. Layout settings

Sets patch, margin, and base color mark printing.



- In RasterLink7, "patches" refer to colored rectangles within the chart preview.

4. [Font]

Sets the text font used for color charts and the title size for each page.

5. Chart preview

Displays the color chart preview.



- Clicking a patch selects that patch and displays its color component densities at the bottom of the screen.
- Right-clicking a patch displays a pop-up menu. The selected colors can be set to base colors 1 to 4.

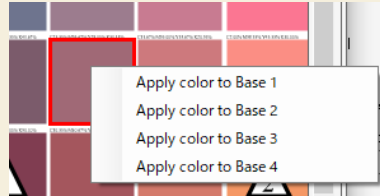

6. Preview display settings

Sets the area displayed in the chart preview.

[Display based on the printable area]: Displays based on the media size for the selected printer.

[Display based on the fixed form]: Displays based on the selected fixed form size and orientation.



- The area set here is the display area on the preview and differs from the actual page size. The actual color chart created will use the [Page size] area enclosed in blue.

7. Pages

Switches between pages created if [Pages ±] in [Page direction] is set to more than one page.

CMYK Color chart - Operations

● Add a color chart definition file

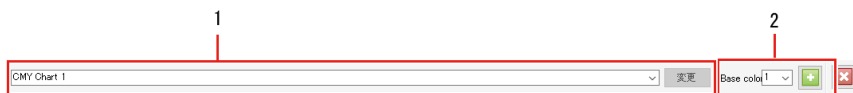

- 1 Enter the name of the definition file for the new color chart to be created in the input box for chart name on the [CMYK Color chart] screen.

2 Select the number of base colors from the [Base colors] list, then click the  icon. Three different charts can be created, depending on the number of base colors.

- [1 base colors] : Creates a color chart based on one base color with color components (CMYK) varied in three directions across height, width, and pages.

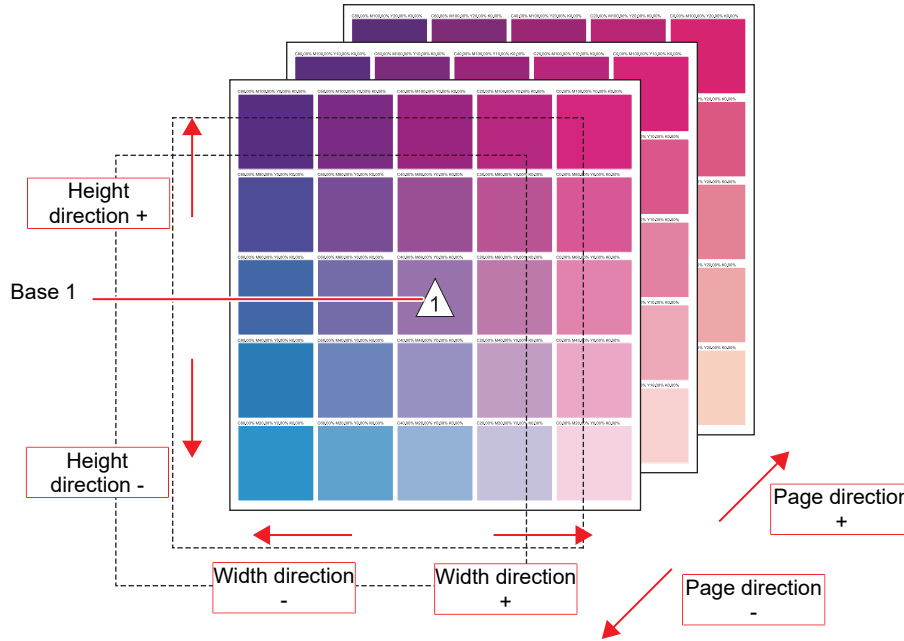

- [2 base colors] : Varies two base colors across the width direction. Also creates a color chart with color components (CMYK) varied in two directions across height and pages.

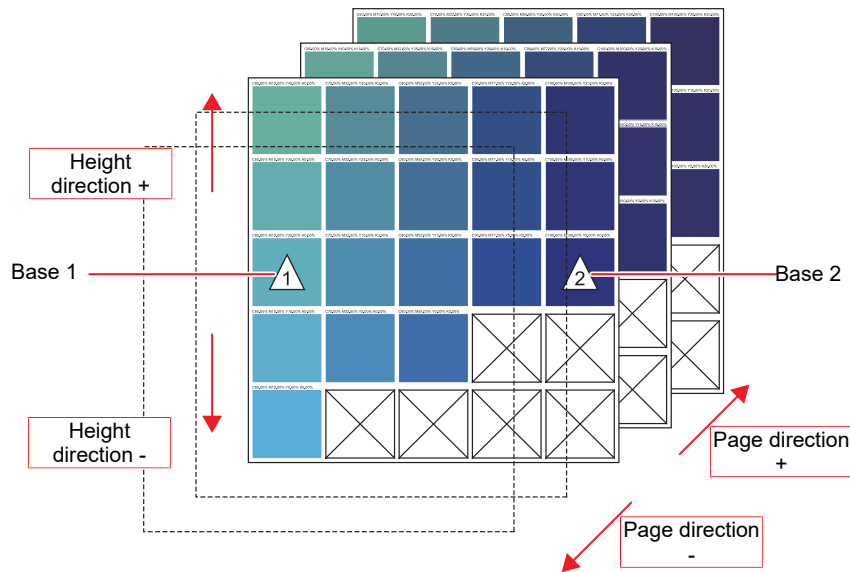

- [4 base colors] : Varies four base colors across the width and height directions. Also creates a color chart with color components (CMYK) varied across pages.

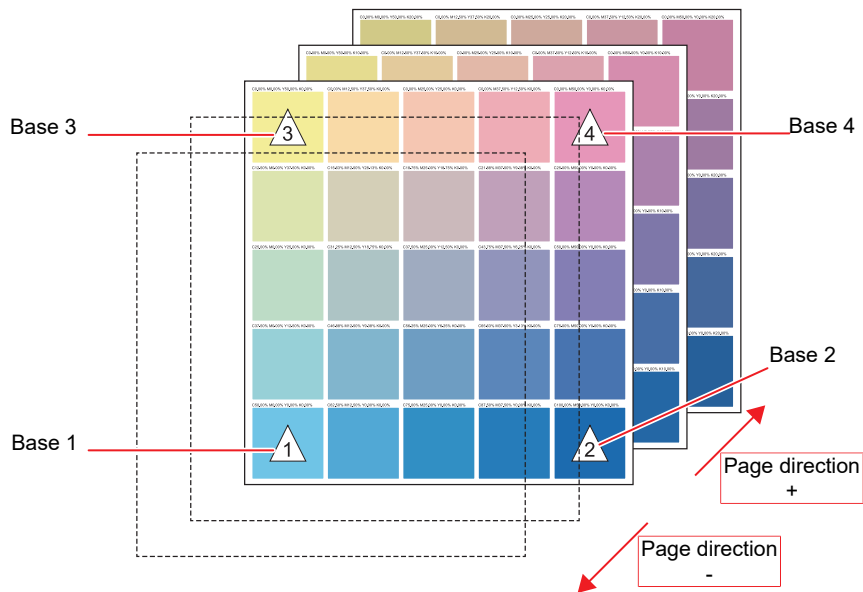

- If a color chart definition file with the same name already exists, an overwrite confirmation dialog will appear. Overwriting will change all of the values.

● Edit a color chart definition file



1 Select the name of the color chart to be set in the pull-down menu for chart definition file name on the [CMYK Color chart] screen.

2 Enter the CMYK density in the Color settings base color input boxes.

- The square to the right of the input boxes changes to the color input.



- Clicking the square displays a color selection dialog. Click the desired color from the displayed colors to set the base color.

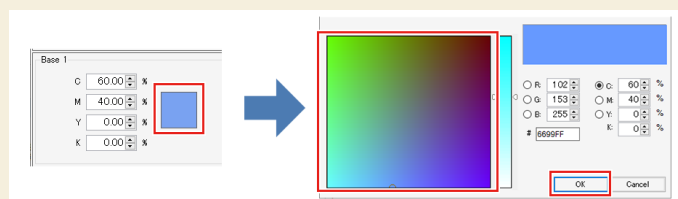

3 Set the value in the [Width direction] patches input box.

- This varies the number of patches in the width direction on the color chart.



- If only one base color was set, the color component (CMYK) to be varied in the width direction is set together with the increment (%).

4 Set the value in the [Height direction] patches input box.

- This varies the number of patches in the height direction on the color chart.



- If one or two base colors were set, the color component (CMYK) to be varied in the height direction is set together with the increment (%).

5 Set the value in the [Page direction] pages input box.

- This varies the number of color chart pages.



- Set the color component (CMYK) to be varied in the page direction and the increment (%).

6 Configure the various settings for the color chart patches in [Patch].

[Size] : Sets the size (width and height) of each patch.

[Interval] : Sets the spacing (width and height) between patches.

7 Sets the color chart page margins (top, bottom, left, right) in [Margin].

8 To set base color marks to be printed, enable the [Print base color mark] check box in [Option].

- If enabled, a color chart is printed with the Δ symbol added to the base color.



- The base color Δ symbol is displayed in the chart preview regardless of the [Print base color mark] setting.
- Clicking [Update] on the [CMYK Color chart] screen once the settings have been completed updates the color chart definition file.

● Create a PDF from a color chart

Create a PDF from a color chart.

1 Select [Create PDF] in the [File] menu on the [CMYK Color chart] screen.

- The [Select condition for Color chart] dialog appears.

2 Specify the PDF size, then click [OK].

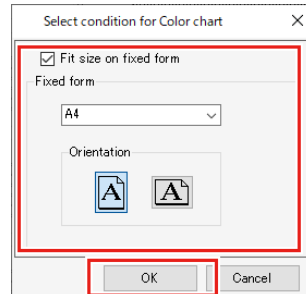

- The [Save] dialog appears.



- Selecting the [Fit size on fixed form] check box allows the color chart PDF media size and orientation to be selected.

3 Enter the file name, then click [Save].

- A PDF is created from the color chart.

● Import a color chart PDF as a job

Automatically imports a color chart PDF as a job.

1 Select [Create Job] in the [File] menu on the [CMYK Color chart] screen.

- The [Select condition to print] dialog appears.
Selecting the [Fit size on fixed form] check box allows the CMYK color chart PDF media size and orientation to be selected.

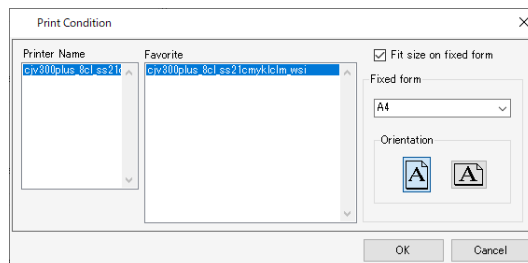

2 Select one [Favorite], then click [OK].

- The CMYK color chart PDF will be imported as a RasterLink7 job.



- The imported job will be the same as a job created by importing a typical multi-page PDF.

● Delete a color chart definition file

1 Select the name of the color chart to be deleted in the pull-down menu for chart name on the [CMYK Color chart] screen.

2 Click the [X] icon.

- The color chart definition file is deleted.

2.3.3 Special Color chart

The special color chart printed is used to specify the ink density for colors after replacement using  "Color Replacement"(P. 159).

If a printed color including special color ink differs from the intended special color, creating a color chart focusing on that color makes it easier to identify the target color.

This can be used for checking in cases such as when color replacement uses colors including special color ink, such as white and silver.

Special Color chart - Functions

[Special Color chart] allows the following operations.

- Add a special color chart definition file
- Edit a special color chart definition file
- Import a special color chart PDF as a job
- Delete a special color chart definition file

Special Color chart - Screen Layout

● [Special Color chart] screen

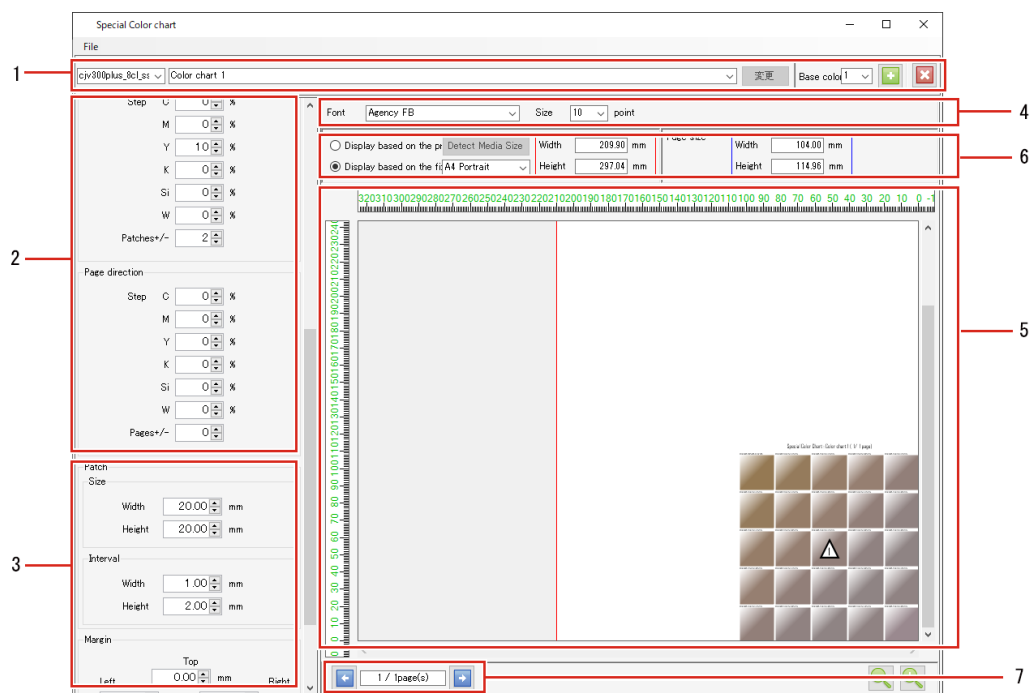

1. Color chart definition file

Adds, selects, deletes, and edits chart definition files.

2. Color settings

Sets the base color(s) and color component variations.

The number of base colors can be selected as 1, 2, or 4.

The details displayed will vary depending on the number of base colors.

With one base color

Ink Limit	
<input type="checkbox"/> Apply profile ink limit	
Base 1	
C	20 % X
M	60 % X
Y	60 % X
K	0 % X
Si	100 % X
W	0 % X
Width direction	
Step	C 0 % X
	M 0 % X
	Y 10 % X
	K 0 % X
	Si 0 % X
	W 0 % X
Patches+/-	2
Height direction	
Step	C 0 % X
	M 0 % X
	Y 10 % X
	K 0 % X
	Si 0 % X
	W 0 % X
Patches+/-	2
Page direction	
Step	C 0 % X
	M 0 % X
	Y 0 % X
	K 0 % X
	Si 0 % X
	W 0 % X
Pages+/-	0

With two base colors

Ink Limit	
<input type="checkbox"/> Apply profile ink limit	
Base 1	
C	10 % X
M	60 % X
Y	0 % X
K	0 % X
Si	41 % X
W	50 % X
Base 2	
C	20 % X
M	0 % X
Y	0 % X
K	0 % X
Si	100 % X
W	0 % X
Width direction	
Base 1	Base 2
Height direction	
Step	C 0 % X
	M 0 % X
	Y 0 % X
	K 0 % X
	Si 0 % X
	W 0 % X
Patches+/-	1
Page direction	
Step	C 0 % X
	M 0 % X
	Y 0 % X
	K 0 % X
	Si 0 % X
	W 0 % X

With four base colors

Ink Limit	
<input type="checkbox"/> Apply profile ink limit	
Base 1	
C	65 % X
M	31 % X
Y	0 % X
K	25 % X
Si	0 % X
W	65 % X
Base 2	
C	30 % X
M	0 % X
Y	48 % X
K	0 % X
Si	0 % X
W	50 % X
Base 3	
C	0 % X
M	35 % X
Y	0 % X
K	0 % X
Si	0 % X
W	45 % X
Base 4	
C	0 % X
M	5 % X
Y	10 % X
K	0 % X
Si	100 % X
W	0 % X
Patches	
Base 3	Base 4
	3

3. Layout settings

Sets patch, margin, and base color mark printing.

4. [Font]

Sets the text font used for special color charts and the title size for each page.

5. Chart preview

Displays the color chart preview.



- Clicking a patch selects that patch and displays its color component densities at the bottom of the screen.
- Right-clicking a patch displays a pop-up menu. The selected colors can be set to base colors 1 to 4. The selected colors can also be registered in a color collection.

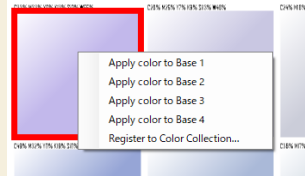

6. Preview display settings

Sets the area displayed in the chart preview.

[Display based on the printable area]: Displays based on the media size for the selected printer.

[Display based on the fixed form]: Displays based on the selected fixed form size and orientation.



- The area set here is the display area on the preview and differs from the actual page size. The actual color chart created will use the [Page size] area enclosed in blue.

7. Pages

Switches between pages created if [Pages ±] in [Page direction] is set to more than one page.

Special Color chart - Operations

● Add a special color chart definition file

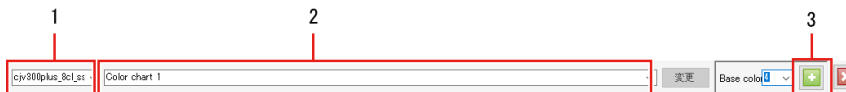

1 Select the printer in the pull-down menu to the left of chart name on the [Special Color chart] screen.

- A color chart can be created using the special color inks for the printer selected.

2 Enter the name of the new color chart definition file to be created in the input box on the right.

3 Select the number of base colors from the [Base colors] list, then click the  icon. Three different charts can be created, depending on the number of base colors.

- [1 base colors] : Creates a special color chart based on one base color with color components varied in three directions across height, width, and pages.

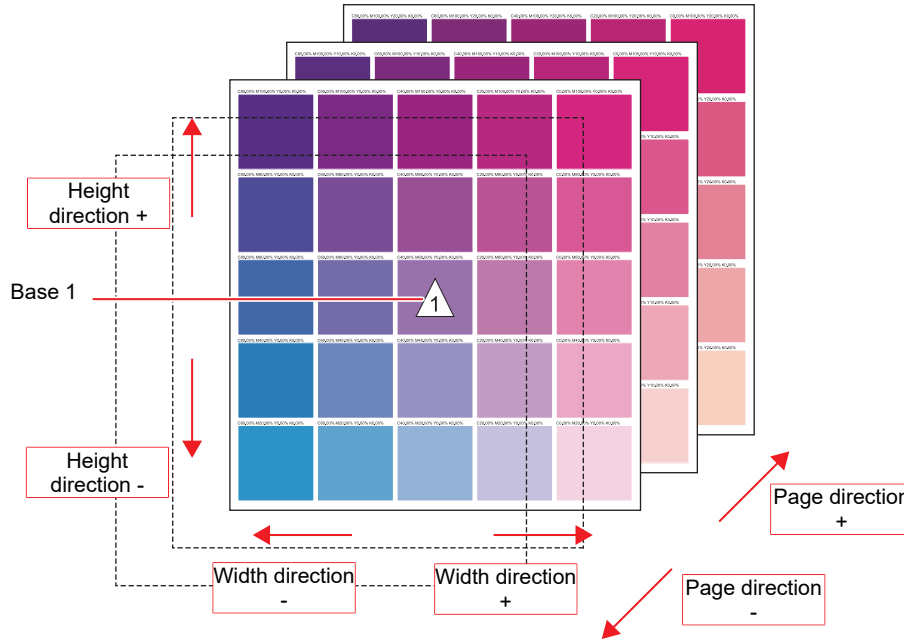

- [2 base colors] : Varies two base colors across the width direction. Also creates a special color chart with color components varied in two directions across height and pages.

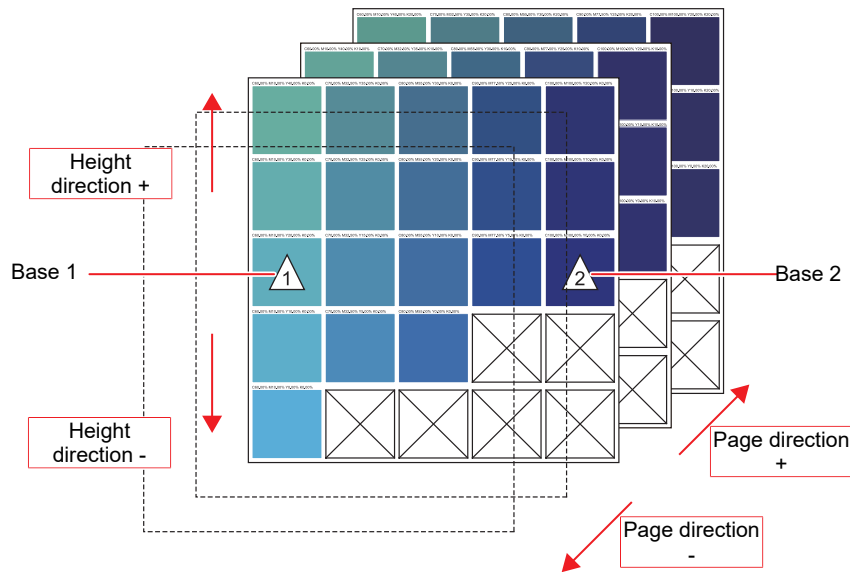

- [4 base colors] : Varies four base colors across the width and height directions. Also creates a special color chart with color components varied across pages.

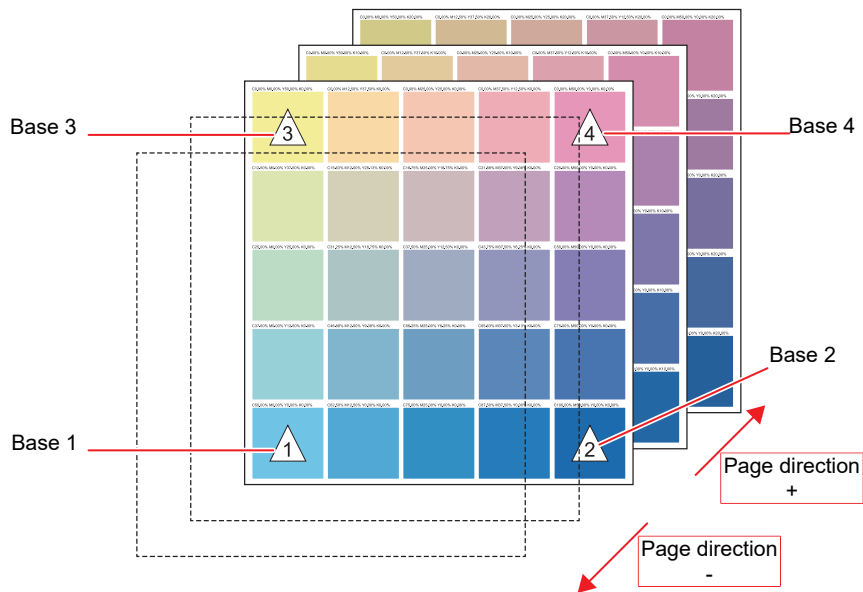

- If a color chart definition file with the same name already exists, an overwrite confirmation dialog will appear. Overwriting will change all of the values.

● Edit a special color chart definition file



1 Select the name of the color chart definition file to be set in the pull-down menu for chart definition file name on the [Special Color chart] screen.

2 Select or deselect the [Apply profile ink limit] check box.



Selecting this applies the ink limit set in the device profile. This enables ink overflowing to be minimized.



- [Apply profile ink limit] will always be enabled if the inkset has three or more slots for special color inks.

3 Enter the ink density in the Color settings base color input boxes.

- The square to the right of the input boxes changes to the color input.



- Clicking the square displays the [Color Collection] dialog. Click the desired color from the color collection displayed to set the base color.

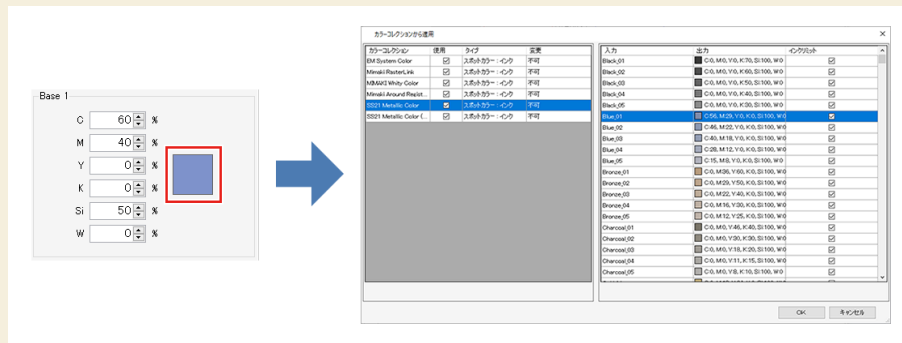

4 Set the value in the [Width direction] patches input box.

- This varies the number of patches in the width direction on the color chart.



- If only one base color was set, the ink density (%) to be varied in the width direction is set.

5 Set the value in the [Height direction] patches input box.

- This varies the number of patches in the height direction on the color chart.



- If one or two base colors were set, the ink density (%) to be varied in the height direction is set.

6 Set the value in the [Page direction] pages input box.

- This varies the number of color chart pages.



- The ink density (%) to be varied in the page direction is set.

7 Configure the various settings for the color chart patches in [Patch].

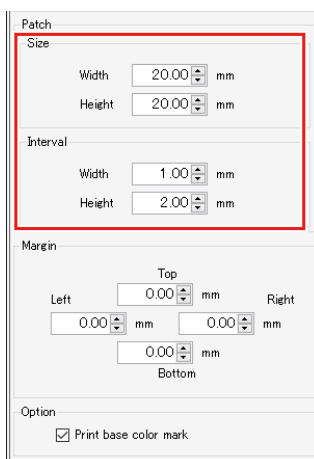

[Size] : Sets the size (width and height) of each patch.

[Interval] : Sets the spacing (width and height) between patches.

- 8 Sets the color chart page margins (top, bottom, left, right) in [Margin].
- 9 To set base color marks to be printed, enable the [Print base color mark] check box in [Option].
 - If enabled, a color chart is printed with the Δ symbol added to the base color.



- The base color Δ symbol is displayed in the chart preview regardless of the [Print base color mark] setting.
- Clicking [Update] on the [Special Color chart] screen once the settings have been completed updates the color chart definition file.

● Import a special color chart PDF as a job

Automatically imports a special color chart PDF as a job.

1 Select [Create Job] in the [File] menu on the [Special Color chart] screen.

- The [Select condition to print] dialog appears.
Selecting the [Fit size on fixed form] check box allows the special color chart PDF media size and orientation to be selected.

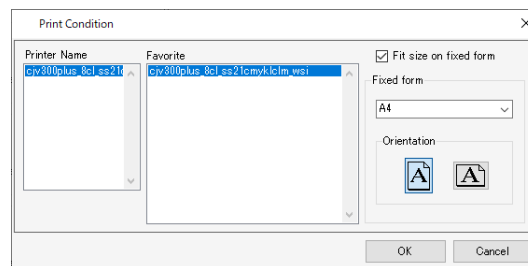

2 Select one [Favorite], then click [OK].

- The special color chart PDF will be imported as a RasterLink7 job.



- The imported job will be the same as a job created by importing a typical multi-page PDF.
- The imported job has color replacement set on the Color Replacement screen.

● Delete a special color chart definition file

1 Select the name of the special color chart definition file in the pull-down menu for chart definition file name on the [Special Color chart] screen.

2 Click the [X] icon.

- The special color chart definition file is deleted.

2.3.4 Lab Color Chart

Lab Color Chart is a function that assists in creating and printing a color chart based on Lab values and for using it to specify the colors after color replacement in "Color Replacement"(P. 159).

The function, screen, and operations are the same as for "Special Color chart"(P. 219). Each ink color should be read replaced as "Lab".

2.3.5 Color Collection

Sets color collections and automatically replaces colors.

● About color collections

Color collections contain color replacement  "Color Replacement"(P. 159) information.

Collection files can be created separately for color information before and after replacement to suit requirements.

● Color Collection screen display

Open [Color Collection] in the [Tool] menu.

Or click  on the Color Replacement screen.

Color Collection - Functions

[Color Collection] allows the following operations.

- Check color collection settings
- Add a color collection
- Edit a color collection
- Duplicate a color collection
- Delete a color collection
- Create an Adobe Illustrator swatch file

Color Collection - Screen Layout

● [Color Collection] screen

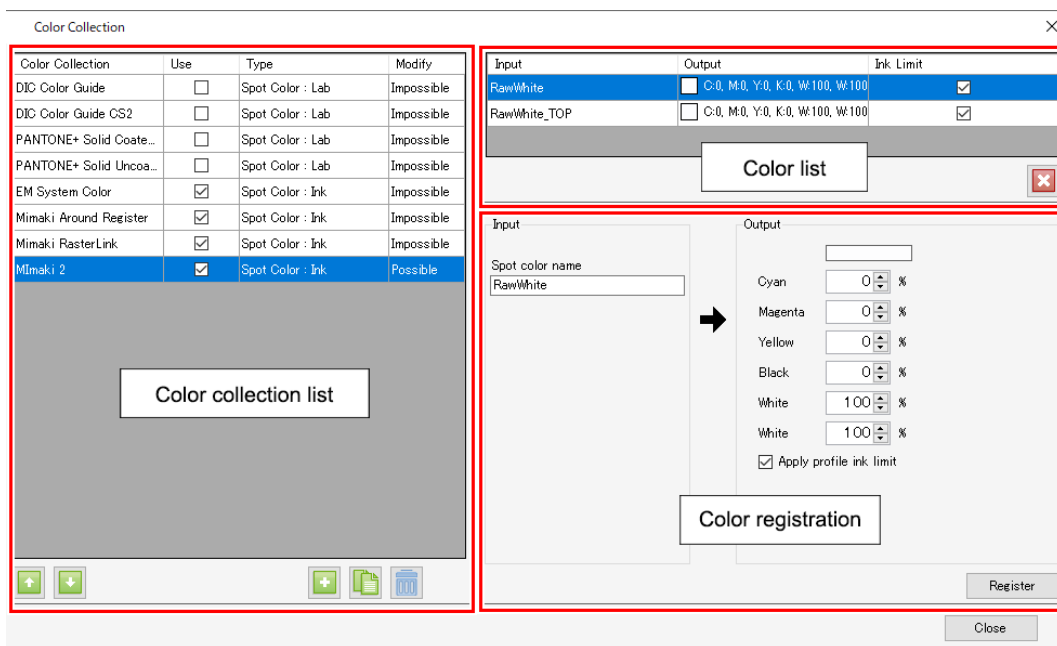

● Color collection list

Displays the list of color collections that can be used with the printer displayed in RasterLink7.

• [Color Collection]

Displays the color collection file name.

• [Use]

If selected, colors are replaced automatically in accordance with the color collection settings when the original image is imported.

• [Type]

Displays the color collection type.

Color collection type		Colors replaced
Spot color	Ink	The spot color is replaced by the printer ink.
	Lab	The spot color is replaced by the Lab values.
CMYK	Ink	The CMYK process color is replaced by ink.
	Lab	The CMYK process color is replaced by the Lab values.
Gradation		Gradation is replaced with the gradation set.

• Modify

Indicates whether or not the color can be modified.

● Notes about preset color collections

The following color collections are preset. These color collections cannot be modified.

- **DIC Color Guide Spot Colors^{*1} (Type: Lab)**

Color collection name	Adobe Illustrator version
DIC Color Guide	8 to CS supported
DIC Color Guide CS2	CS2 onward supported

- **PANTONE® Color Spot Colors^{*1} (Type: Lab)**

Color collection name	Number of colors
PANTONE+ Solid Coated-V3	1867
PANTONE+ Solid Uncoated-V3	
PANTONE(R) Solid Coated-V4	2161
PANTONE(R) Solid Uncoated-V4	
PANTONE(R) Solid Coated-V5	2390
PANTONE(R) Solid Uncoated-V5	

- **Spot colors that can be replaced by special color inks (white, clear, primer) only^{*2, *3} (Type: Ink)**

Color collection name	Adobe Illustrator swatch file	Remarks
Mimaki RasterLink	MIMAKI RasterLink Library	"CutContour" is included in the swatch file.

- **Spot colors that use white ink^{*2, *3} (Type: Ink)**

Color collection name	Adobe Illustrator swatch file
Mimaki Whity Color	MIMAKI Whity Library 370

• **Spot colors that use silver ink**^{*2, *3} (Type: Ink)

Color collection name	Adobe Illustrator swatch file	When usable
SS21 Metallic Color	MIMAKI Metallic Color Library	• When using SS21 silver ink
SS21 Metallic Color (No Silver)		• When using SS21 silver ink ^{*4}
Metallic Color (No Silver)		• When using MUH-100 (silver ink) ^{*4}
SS21 Metallic Orange Color	MIMAKI SS21Metallic Orange Color	• When using SS21 orange or silver ink
SS21 Metallic Orange Color (No Silver)		• When using SS21 orange or silver ink ^{*4}

• **Spot colors that use fluorescent ink (fluorescent yellow, fluorescent pink)**^{*2, *5} (Type: Ink)

Color collection name	Adobe Illustrator swatch file	When usable
Artista Textile Color Collection	Artista Textile Color Collection	• When using sublimation transfer ink 411 fluorescent yellow or fluorescent pink

- *1. With the initial default settings, if an imported image contains the same color information as within the color collection, the output data is automatically set to not have color replaced automatically. If you wish to have colors replaced automatically, set "Use" to "ON".  ["Color Collection - Screen Layout"](#)(P. 227)
- *2. The Adobe Illustrator swatch file is located in the following folder.
RasterLink installation folder/Swatch/Illustrator
- *3. The color charts (PDF) specifying the color collection spot colors are located in the following folder.
RasterLink installation folder/ColorChart/Default
- *4. Silver ink is not included in colors after replacement. This is used when creating a silver plate separately.
For more information refer to the separate "Metallic Color Printing Guide".
- *5. The color charts (PDF) specifying the color collection spot colors are available on the official Mimaki website.
<https://mimaki.com/topics/product/artista/atcc-download.html>

● **Color list**

Displays the colors registered in the color collection file selected from the color collection list.

● **Color registration**

Registers and edits color settings (colors before and after replacement) in the color collection file selected from the color collection list. Refer to  ["Color Replacement - Functions"](#)(P. 159).

Color Collection - Operations

● Check color registration settings

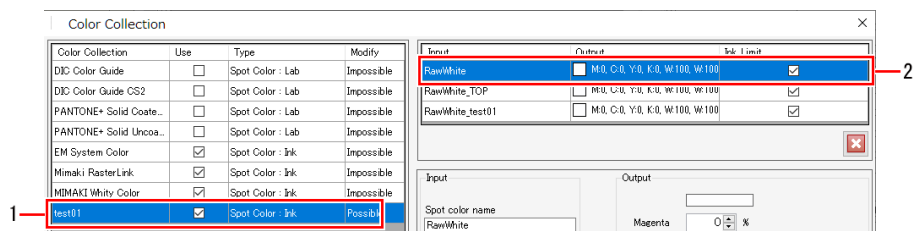

1 Select a color collection file from the color collection list on the [Color Collection] screen.

- The color list is displayed.

2 Select a color in the color list.

- The color settings before and after replacement are displayed in color registration.

● Automatically replace a color in accordance with color collection settings

1 Select the color collection to be used and select a [Use] check box in the color collection list on the [Color Collection] screen.

2 Click the [] icons to reorder the color collection.

- The color collection order of priority is modified.
- If the [Use] check box is selected for more than one color collection and they contain the same conditions, the color collections higher in the list will be applied.

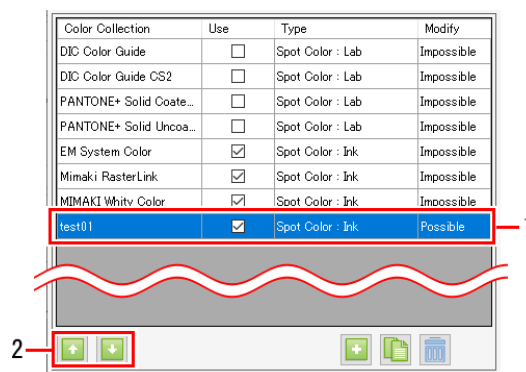

- The color collection will be applied automatically when a new image is imported.

● Add a color collection

1 Click the [] icon on the color collection list on the [Color Collection] screen.



- The [Add] dialog appears.

2 Select the color collection type in the [Type] list in the [Add] dialog.

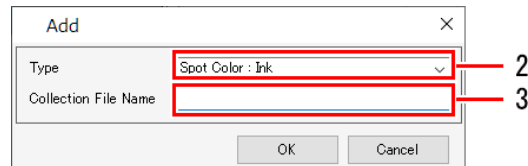

3 Enter the color collection file name in [Collection File Name].

- The color collection is added.

● Edit a color collection

1 Select one color collection file from the color collection list on the [Color Collection] screen.

Color Collection	Use	Type	Modify
DIC Color Guide	<input type="checkbox"/>	Spot Color : Lab	Impossible
DIC Color Guide CS2	<input type="checkbox"/>	Spot Color : Lab	Impossible
PANTONE+ Solid Coate...	<input type="checkbox"/>	Spot Color : Lab	Impossible
PANTONE+ Solid Uncoa...	<input type="checkbox"/>	Spot Color : Lab	Impossible
EM System Color	<input checked="" type="checkbox"/>	Spot Color : Ink	Impossible
Mimaki RasterLink	<input checked="" type="checkbox"/>	Spot Color : Ink	Impossible
MIMAKI Whity Color	<input checked="" type="checkbox"/>	Spot Color : Ink	Impossible
test01	<input checked="" type="checkbox"/>	Spot Color : Ink	Possible

2 Set the color information before replacement in [Input] in the register area.

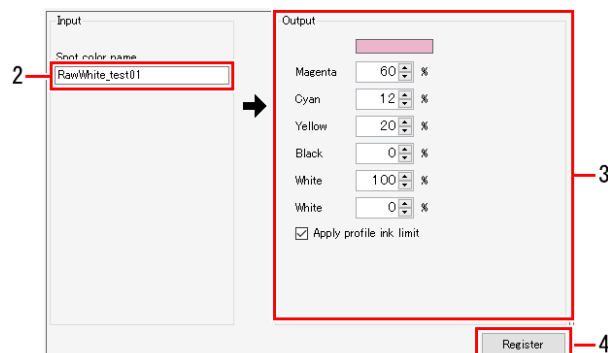

- The color information that can be set will vary depending on the color collection type. Refer to [P. 159](#).

3 Set the color information after replacement in [Output] in the register area.



- The color information that can be set will vary depending on the color collection type. Refer to [P. 159](#).

4 Click [Register].

- The color is added to the color list.



- To delete a color, select the color to be deleted in the color list, then click the icon.

● Duplicate a color collection

- 1 Select the color collection to be duplicated in the color collection list on the [Color Collection] screen.

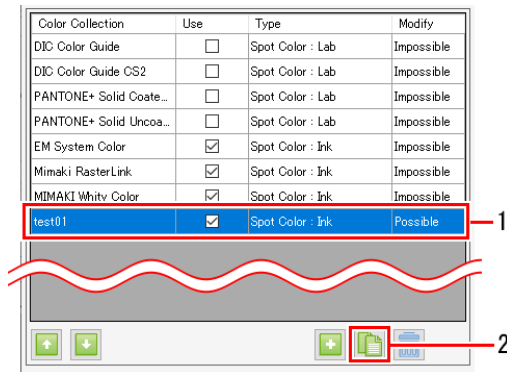

- 2 Click the  icon.

- 3 Enter the color collection file name in [Collection File Name] in the [Duplicate] dialog.

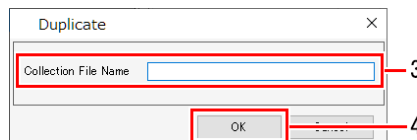

- 4 Click [OK].

- The color collection is duplicated.

● Delete a color collection

- 1 Select the color collection to be deleted in the color collection list on the [Color Collection] screen.

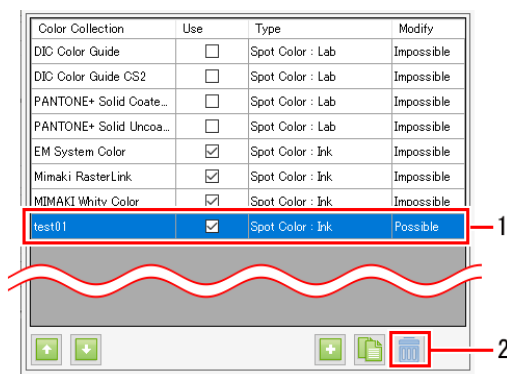

- 2 Click the  icon.

- A [Confirmation] dialog appears.
- Clicking [Yes] deletes the color collection.

Important!

- Color collections cannot be deleted if [Modify] is indicated as [Impossible].

● Create an Adobe Illustrator swatch file

- 1 Select the color collection for which you want to create a swatch in the color collection list on the [Color Collection] screen.

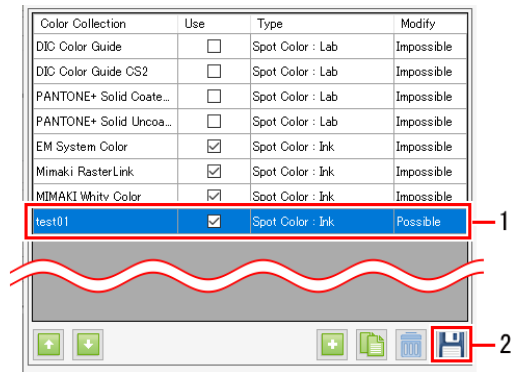

- 2 Click the  icon.

- The [Select file name to save] dialog appears.

- 3 Enter the file name for [File Name] in the [Select file name to save] dialog, then click [Save].

- An Adobe Illustrator swatch file will be created.
- The file types vary as follows due to the application used by the swatch file.
 - For Adobe Illustrator : Illustrator (AI)
 - For CorelDRAW X4 or lower : CorelDRAW(CPL)
 - For CorelDRAW X5 or later : CorelDRAW(XML)

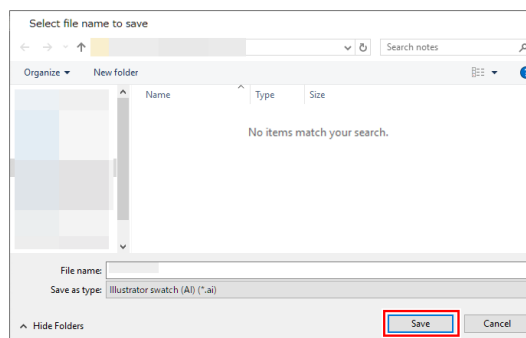

Important! Adobe Illustrator swatch files cannot be created in the following cases.

- With color collections for which [Modify] is indicated as [Impossible]
- With color collection files for which [Type] is [Gradation], [CMYK: Ink], or [CMYK: Lab]

2.3.6 Calibration

Calibration can be performed using RasterLink7 by installing a separate calibration tool.

For more information on how to set up and use the calibration tool, refer to the separate "Calibration Tool Guide".

2.3.7 Profile Manager

Profile Manager can be launched from RasterLink7 to install and uninstall profiles.

For more information, refer to the separate "Profile Manager Reference Guide".



- RasterLink7 and Profile Manager can be running at the same time, and profiles installed and uninstalled using Profile Manager are immediately updated in RasterLink7.

2.3.8 Mimaki Remote Access

Mimaki Remote Access ("MRA") is a remote access tool that allows information acquisition and panel operation of Mimaki printers and plotters from a remote location.

MRA can be launched provided it is installed on the same PC on which RasterLink7 is installed and the currently selected printer supports MRA.

2.4 Environments

This section explains the various setting procedures.
Select from the [Environments] menu at the top of the main screen.

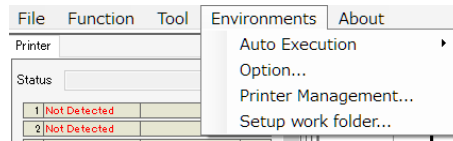

2.4.1 Auto Execution

This is a function for automatically starting ripping and outputting when image data is imported.

Execute - Functions

The process for [Auto Execution] is as follows.

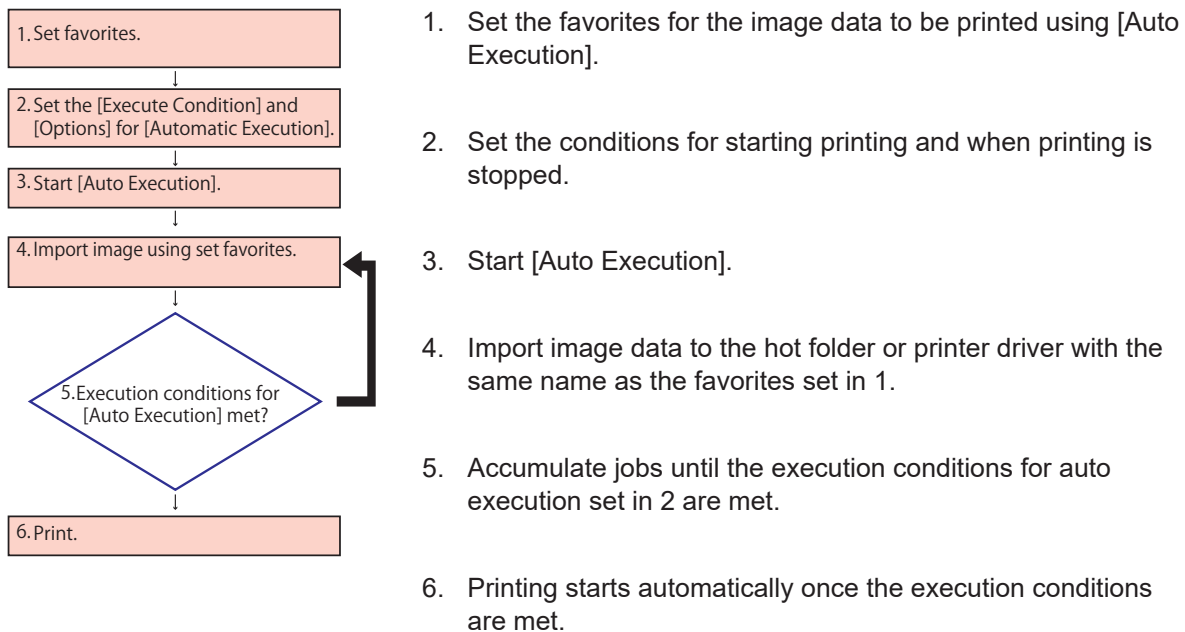

Important!

- Jobs that are awaiting printing under auto execution (with light blue backgrounds) cannot be operated on using the various menus. If you wish to work on a job, first stop [Auto Execution].

● Conditions

The following operations are not possible with [Auto Execution].

- [Composite]
- [Tiling]
- [Step & Repeat]
- [Jig Print] (with flatbed printers)
- Fotoba cut mark printing
- Braille Printing
- Jobs with register marks added in FineCut

Execute - Screen Layout

● [Auto Execution] tab in [Environments] menu - [Option] dialog

Set [Execute condition], [Option], and [Extended function] on [Auto Execution] tab.

Option

Job Control **Auto Execution** Display Disk Device Communication

Execute condition

Arranged print

By Number of jobs

By Paper length(only for roll to roll) mm

By Printable area full (only for flat printer)

Space

Printer Name

Scan margin mm

Feed margin mm

Arrange in the Center

Individual print

Option

Stop auto-execution if the image exceeds media size

Stop Job Queue if an error occurred during auto-execution

Printer Settings

Printer Name

Delete ripped data after print

Delete Job after print

Extended function

Refresh media information

OK Cancel

Execute - Operations

● Set favorites

1 Sets the favorite settings to be applied when original image data is imported.

- For more information on how to set favorites, refer to  "Favorite"(P. 176).



- Color replacement applies the color collection settings.  "Color Collection"(P. 226)

● Start [Auto Execution]

1 Select [Environments] - [Option].

- The [Option] dialog appears.

2 Select the [Auto Execution] tab in the [Option] dialog

3 Set [Execute condition].



- Jobs that are awaiting printing (with light blue backgrounds) cannot be edited. If you wish to edit such jobs, first stop auto execution.

- [Arranged print]:

Jobs are held until any of the following the conditions is met, and are then arranged and printed using the minimize alignment mode.

- [By Number of jobs]

When this is selected, printing starts once the specified number of jobs has been imported.

- [By Paper length(only for roll to roll)] (With roll-to-roll printers)

When this is selected with a roll-to-roll printer, the imported jobs are arranged using the minimum area, and printing starts once the specified length has been reached. For more information, refer to the  P. 238 Tips.

- [By Printable area full (only for flat printer)]

When this is selected with a flatbed printer, the imported jobs are arranged using the minimum area, and printing starts when the arranged job exceeds the print area set in the favorite setting.

- [Space]

Sets the width and feed direction margins, and enables/disables center arrangement for each individual printer.

- [Individual print]:

Ripping and printing is executed as soon as image data is imported.



With [Arranged print] Selected

- If [Arranged print] is selected in [Execute condition] and the [By Paper length(only for roll to roll)] check box is selected, the conditions for starting printing of arranged jobs will be as follows.

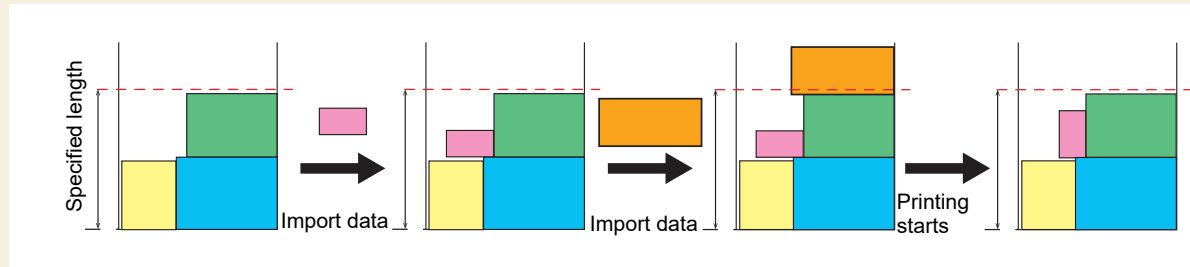

- (1) Image data is imported and the created jobs are arranged using the Minimize mode.
- (2) Jobs continue to be arranged until the specified length is reached.
- (3) The specified length is exceeded.
- (4) Printing starts except for jobs that exceed the specified length.

Example 1: If the created job exceeds the specified length as soon as the first image is imported, the process will be as follows.

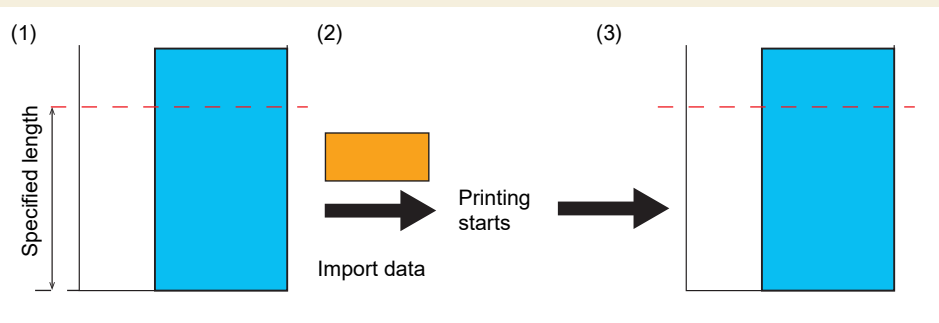



- (1) The specified length is exceeded.
- (2) The next image is imported.
- (3) The job created from the second image is removed and printing starts for the first job only.



The following operations are performed when [Arranged print] is selected:

- When [By Number of jobs], [By Paper length(only for roll to roll)], and [By Printable area full (only for flat printer)] are all deselected, only ripping will be performed automatically, and arrangement and printing will not be performed automatically. To print, stop [Auto Execution], then manually execute printing from the [Execute] menu.
- Jobs will be arranged using [Minimize], so they may be rotated automatically depending on the size.
- When multiple favorites are set for the same printer, arranging and printing will be performed for each favorite setting used when the image data was imported.
- Print jobs and print & cut jobs will be arranged separately.

4 Sets [Option].

- [Stop auto-execution if the image exceeds media size]
Selecting this stops auto execution when a job created from an imported image exceeds the print area.
 - With roll-to-roll printers, this occurs when the media width is exceeded.
 - With flatbed printers, this occurs when the print area set in the favorite settings is exceeded.
- [Stop Job Queue if an error occurred during auto-execution]
Selecting this automatically stops the job queue when an error occurs. Subsequent image data importing, ripping, and printing will also be stopped. Check the error before restarting the job queue.  "[Job Queue] tab"(P. 129)
- [Printer Settings]
Sets deletion of data after printing for each individual printer. For more information, refer to  "Set the deletion processing for data after printing in Execution Option."(P. 130)

5 Set [Extended function].

- [Refresh media information]: Used when using Simple POP. For more information, refer to the Simple POP manual.

6 Select [Environments] menu - [Auto Execution] - [Start].

- Auto execution restarts.
- When auto execution is in progress, [Auto executing] is displayed for [Job Queue].  "[Job Queue] tab"(P. 129)

Job Queue [0] Auto executing			
Thumb...	Job Na...	Status	Progre...

7 Import original print data.

- Printing starts automatically once the execution conditions are met.



For information on how to import jobs, refer to  "Importing Print Data"(P. 13).



- After printing, the settings for  "[Delete ripped data after print] or [Delete Job after print]"(P. 130) on the job [Execute] screen are applied.

● Stop auto execution

1 Select [Environments] menu - [Auto Execution] - [Stop].

- Auto execution stops.



To cancel ripping or printing

- Execute "Stop Job Queue"  "[Job Queue] tab"(P. 129).
Simply selecting [Stop] for [Auto Execution] alone does not cancel ripping or printing.

2.4.2 [Option]

Sets the RasterLink7 performance.

[Option] - Functions

[Option] allows the following operations.

- Set job control
- Set the display
- Set the disk
- Set the colorimeter
- Set the interface
- Set the security

● Conditions

Settings changed in [Option] will be applied after RasterLink7 has been restarted.

[Option] - Screen Layout

● [Environments] - [Option] dialog

Configures the various environmental settings.

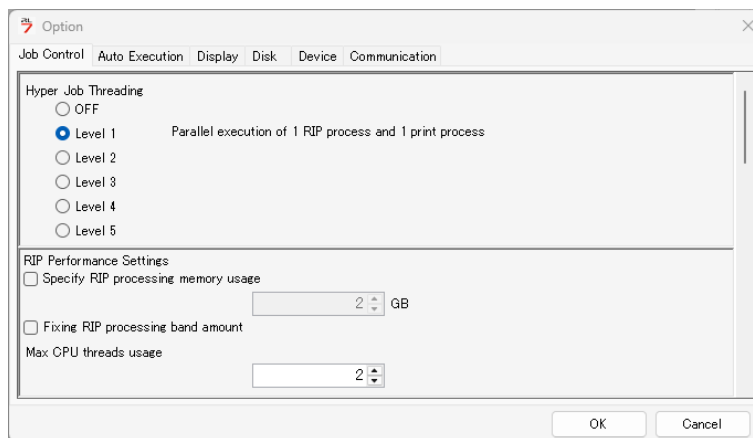

[Option] - Operations

● Set job control

1 Select the [Job Control] tab in the [Environments] - [Option] dialog.

The screenshot shows the 'Option' dialog box with the 'Job Control' tab selected. The dialog is divided into several sections, each with a red box and a number indicating a specific setting:

- 1:** Points to the 'Job Control' tab in the top navigation bar.
- 2:** Points to the 'Hyper Job Threading' section, where 'Level 1' is selected. The description reads: 'Parallel execution of 1 RIP process and 1 print process'.
- 3:** Points to the 'RIP Memory Settings' section, which includes a checkbox for 'Specify RIP processing memory usage' (set to 2 GB) and a checkbox for 'Fixing RIP processing band amount' (set to 2).
- 4:** Points to the 'Create information for estimating ink consumption' dropdown menu, which is set to 'Do not create'.
- 5:** Points to the 'Calculate Ink Consumption from ripped Data' checkbox, which is checked.
- 6:** Points to the 'Notify ink shortage' section, which includes a dropdown for 'Printer Name' (UCJV330) and a 'Remaining ink' spinner set to 10%.
- 7:** Points to the 'Lock the job after printing' checkbox, which is unchecked.
- 8:** Points to the 'RL6Plus compatible' checkbox, which is unchecked.
- 9:** Points to the 'Number of jobs that can be registered' spinner, which is set to 200 count(s).
- 10:** Points to the 'Job execution settings' section, which includes a dropdown for 'Printer Name' (UCJV330), a checkbox for 'Apply job execution settings', a dropdown for 'Execution Order' (Print), and radio buttons for 'Print' (Immediate Print, RIP and Print, RIP Only, Print Only). 'RIP and Print' is selected. It also includes an 'Execution Times' spinner set to 1 time(s) and checkboxes for 'Delete ripped data after print' and 'Delete Job after print'.
- 11:** Points to the 'Output setting' section, which includes a dropdown for 'Printer Name' (UCJV330) and radio buttons for 'Print to output port' (selected) and 'Output command to setting folder'.
- 12:** Points to the 'Mpc Streaming Settings' section, which includes a dropdown for 'Printer Name' (Tiger600-1800TS) and spinners for 'Mpc Streaming Buffer1' (100000), 'Mpc Streaming Buffer2' (8000), and 'Mpc Streaming Splits Line' (8000).
- 13:** Points to the 'Threshold Binary Line' spinner, which is set to 1024.
- 14:** Points to the 'OK' button at the bottom right of the dialog.

2 Select the [Hyper Job Threading] item.

- This sets whether or not to process multiple jobs simultaneously with a single printer.

	Processes and quantities running in parallel	Processes and quantities running in parallel	Processes and quantities running in parallel
[OFF]	Importing image data × 1	RIP × 1	Printing × 1
[Level 1]	Importing image data × 1	RIP × 1 Printing × 1	-
[Level 2]	Importing image data × 1 RIP × 1 Printing × 1	-	-
[Level 3]	Importing image data × 2 RIP × 2 Printing × 1	-	-
[Level 4]	Importing image data × 3 RIP × 3 Printing × 1	-	-
[Level 5]	Importing image data × 4 RIP × 4 Printing × 1	-	-

Important!

- Setting the RIP level to 3 or higher and increasing the number of simultaneous RIP processes increases CPU usage and memory consumption during RIP processing. If a PostScript error occurs at level 3 or higher, set the level to 2 or lower. Data containing high-resolution raster images, or extensive use of transparent objects and gradient objects, tends to significantly increase CPU usage and consume more memory.

3 Specify [RIP Memory Settings] if necessary.

[Specify RIP processing memory usage] : This should normally be disabled. When disabled, ripping is performed automatically using the optimum amount of memory. Depending on the image data, memory may be used up to a level where an error occurs. In cases like this, the amount of memory used can be set to ensure successful ripping.
Setting: 1 to 4 GB

[Fixing RIP processing band amount] : This should normally be disabled. When disabled, the number of lines (bandwidth) for the image data to be processed at a time is calculated automatically depending on the image data, ensuring processing using the optimum number of lines. Depending on the image data, fixing the number of lines may enable ripping to be performed more quickly. If ripping is slow or the image appears to freeze, this setting can be enabled to increase the ripping speed.

Max CPU threads usage : Allows the number of CPU threads used for ripping to be specified.
Setting: 1 to CPU thread count

4 Set [Create information for estimating ink consumption].

- When creating a job, whether or not the data is created for use to calculate the estimated value can be set in  "Estimate ink consumption"(P. 132).

Selection item	Job creation time	Estimate processing	Accuracy	Remarks
[Create]	Slow	Fast	Poor	
[Automatic]	Slow	Medium	Good	Decision on whether or not to create data depends on the job size and favorite settings.
[Do not create]	Normal	Slow	Good	Data is not created. When the estimate function is used, calculation uses the original image data.

5 Select or deselect the [Calculate Ink Consumption from riped Data] check box.

- Selecting this calculates the ink consumption values and displays them in  "Properties"(P. 32).

6 Select or deselect the [Notify ink shortage.] check box.

- When either of the following is printed, a warning is displayed indicating insufficient ink for printing based on the calculated value and ink level.
 - The [Calculate Ink Consumption from riped Data] check box is selected and the ink consumption has been calculated before printing.
 - [Ink Consumption Estimation] has previously been performed.
- Printer name
Select the printer for ink level adjustment.
- Ink level
Adjust the threshold ink level for warnings, as needed.
The default value varies depending on the model.

7 Select or deselect the [Lock the job after printing] check box.

- Selecting this displays a lock symbol for the job after printing, preventing the settings for that job from being edited or deleted.

8 Select or deselect the [RL6Plus compatible] check box.

- When selected, the processing for the following items will be the same as for RasterLink6Plus.
 - If a flatbed printer is used for composites consisting of continuous special color jobs, these will be combined into separate outputs.
 - When using special color, the same special color over print as RasterLink6Plus is set as the default.

9 Change [Number of jobs that can be registered] as necessary.

- Default: 200, maximum: 1,000
Increasing the number of registered jobs increases the amount of image data displayable on the [Job List] tab. However, it also increases the time taken to display the [Job List] tab after starting up RasterLink7.

10 Enable or disable [Job execution settings].

- Enabling this displays the option screen settings as the default values on the execute screen.

11 Specify [Output setting] if necessary.

- [Print to output port] should normally be selected.
This outputs to the output port set when the printer was registered.
- Output for other settings will be as follows depending on the combination of output ports set when the printer was registered:

Output setting	Output port at printer registration		
	USB2.0	Ethernet	File
[Print to output port]	USB2.0	Ethernet	File
[Output command to setting folder]	Setting folder	Setting folder	Setting folder
[Output command to configuration folder and print to output port]	Setting folder	Setting folder	Setting folder
	USB2.0	Ethernet	-

- The command is output to the configuration folder with the file name in the format "Date_Time_Jobname.bin".
Example: 20240701_123001_Test job.bin
- The configuration folder is set using [Select output folder] on the printer status screen.

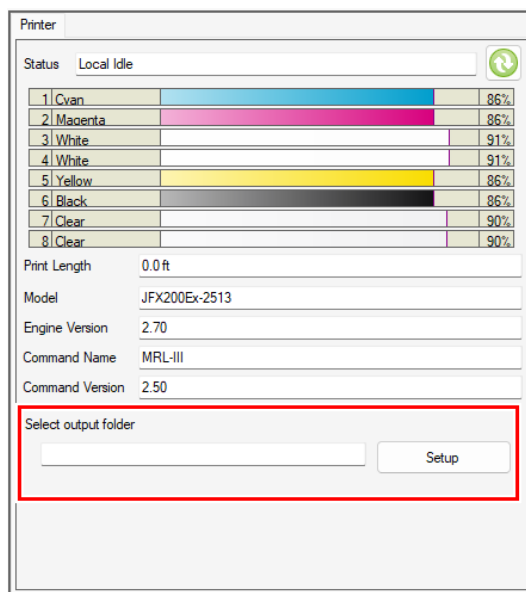

- When using the JFX600-2531, JFX600-2513, or Tiger600-1800TS, the [Output setting] cannot be specified.

12 Configure the [Mpc Streaming Settings].

- This setting is displayed when Tiger600 is registered as a printer.
- This setting should not normally be changed. If the carriage stops during printing due to the PC specifications or network environment, try increasing the values.

13 Set [Threshold Binary Line].

- This setting should not normally be changed. If the carriage stops during printing due to the PC specifications or network environment, try increasing the values.

14 Click [OK].

- Settings that have been changed will be applied after restarting RasterLink7.

Save execution results to a file

Selecting this check box outputs the execution results in CSV format once printing and cutting are complete if a save destination is set.

- File output setting method

1 Select the [Save execution result to a file] check box.

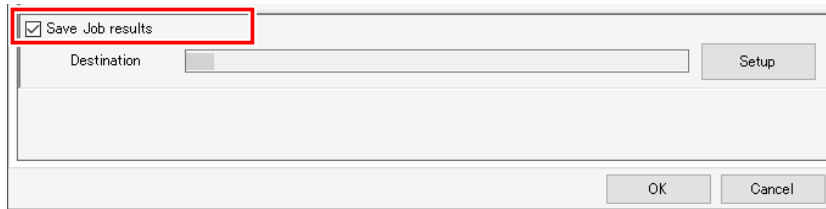

- When initially specifying the save destination, the file save destination selection dialog appears automatically. In such cases, proceed to Step 3.

2 Click [Setup].

- The file save destination selection dialog appears.

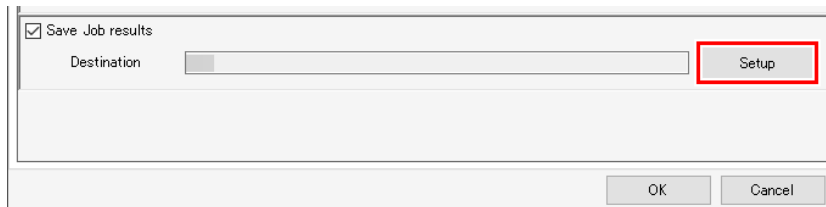

3 Select the save destination for the output file, then click [Select].

4 Click [OK].



- The following information will be output.

For printing

File name, results, ink consumption results, ripping start time, ripping end time, printing start time, printing end time, number of executions, detailed results

For cutting

File name, results, ink consumption results, cutting pass creation start time, cutting pass creation end time, cutting start time, cutting end time, number of executions, detailed results

Display print length warning

After outputting a specific job, a warning will be displayed when the total print length reaches the specified length. This is displayed and can be set when the following printer is registered:

Printer: UCJV330

- 1** Select the printer to be set from [Printer Name].
- 2** Select or deselect the [After executing 2.5D printing, display warning according to following print length.] check box.
 - The print length can be specified when this is selected.



Warning timing

Continuing to wind 2.5D printed media may cause meandering. The warning is intended to alert you about this.

- After launching RasterLink7, the start of 2.5D printing on the printer involved is treated as zero, and the warning is displayed before starting printing that will reach the specified length, regardless of the job type.
- After the warning is displayed, restarting 2.5D printing counts the print length from zero again.
- The print length counter will be reset to zero when RasterLink7 is restarted.

Set the [Execute] icon operation on each function screen

Set the operation performed by clicking [Execute] on the [General Print], [Tiling], and [Step & Repeat] screens.

The settings are configured separately for each printer registered.

- 1** Select the printer to be set from [Printer Name].

- 2** Select the [Apply job execution settings] check box.

- If this is not selected, the previously used conditions will be used.

- 3** Sets the execution procedure.

- The setting details are the same as for "Execute"(P. 127).

● Set the display

1 Select the [Display] tab in the [Environments] - [Option] dialog.

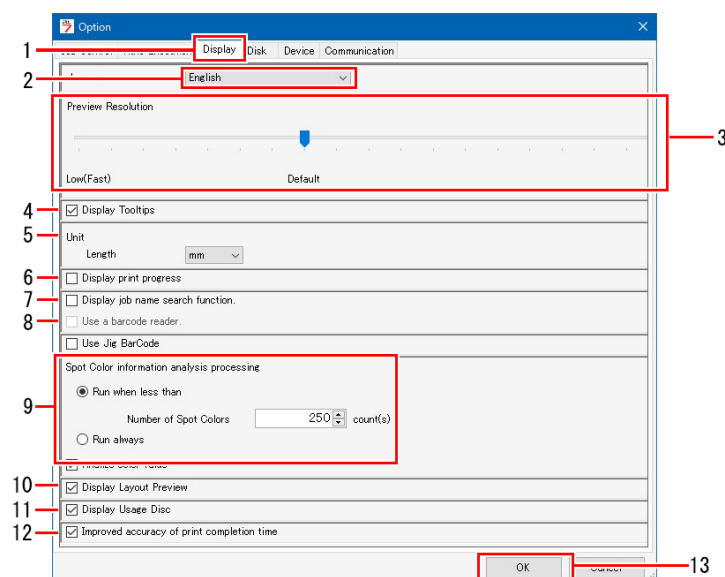

2 Select the display language from the [Language] pull-down menu.

- Set the display language used for RasterLink7.

3 Adjust the [Preview Resolution] slider.

- Moving the slider to the right increases the display resolution on the [Preview] window but makes the preview slower.
- Moving the slider to the left reduces the display resolution on the [Preview] window but makes the preview faster.

4 Select or deselect the [Display Tooltips] check box.

- When this is selected, simple explanations (tool tips) are displayed for individual items at the mouse cursor position.

5 Select [Unit].

- Set the display units for length to mm or inch.

6 Select or deselect the [Display print progress] check box.

- If this is selected and connected to the printer, Print progress is displayed during printing. 📖 P. 18

7 Select or deselect the [Display job name search function.] check box.

- When this is selected, the job name search input box is displayed.
- The job name search input box enables jobs to be searched. 📖 "Job Name Search"(P. 288)

8 Select or deselect the [Use a barcode reader.] check box.

- Selecting this allows search parameters created as barcodes using standard barcode conversion software to be imported to RasterLink7. 📖 "Search Using a Barcode Reader"(P. 290)

9 Set the movement when image data for which spot colors are specified is loaded.

[Run when less than] : The spot color information is analyzed when the number of spot colors within the image data is smaller than the value set.
If the number of spot colors is equal to or greater than the value set, image data is loaded faster since analysis is not performed.

[Run always] : The spot color information is always analyzed regardless of the number of spot colors within the image data.

Important! The following restrictions apply to jobs created without executing [Spot color information analysis processing]:

- The density of the spot color selected in the color replacement list will not be displayed on the [Color Replacement] screen.

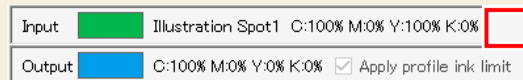

In the input colors, CMYK are all shown as 0% if the selected spot color has been set as a gradation object color.

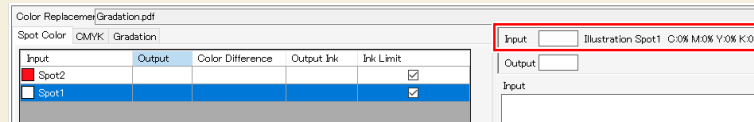

- The input/output information will not be displayed even when the cursor is hovered over the position for the specified spot color in the preview.

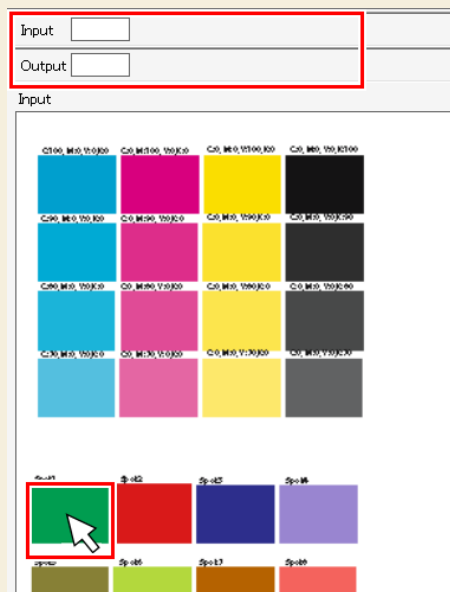

- The spot color position will not be highlighted in the preview even when a spot color has been selected from the color replacement list and the [Display selected color in negative] check box is checked.

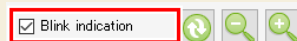

- The spot color in the color replacement list will not be selected even when the spot color position is clicked in the preview.
- If single color replacement has been used, the position of the specified spot color will be determined as having no color in the preview. The actual printing will be performed normally.

[Analyze color value] : Errors may occur if imported image data contains a large amount of vector objects with spot colors specified. In this case, clear the check box.

10 Set [Display Layout Preview].

- Selecting this displays the layout preview on the main screen.  P. 17

11 Set [Display Usage Disc].

- Selecting this displays the amount of disk usage on the main screen.  P. 17

12 Select [Improved accuracy of print completion time].

This will change the display when selecting [Properties] - [Results] - [Time] - [Print] as follows.

 P. 34

- Selecting this displays the time from the start of printing until printing is complete.
- Unselecting this displays the time from the start of printing until data has been sent to the printer.

13 Click [OK].

- Settings that have been changed will be applied after restarting RasterLink7.



- For more information on the jig barcode function, refer to the separate "Jig Barcode Function Guide".

- **Set the disk**

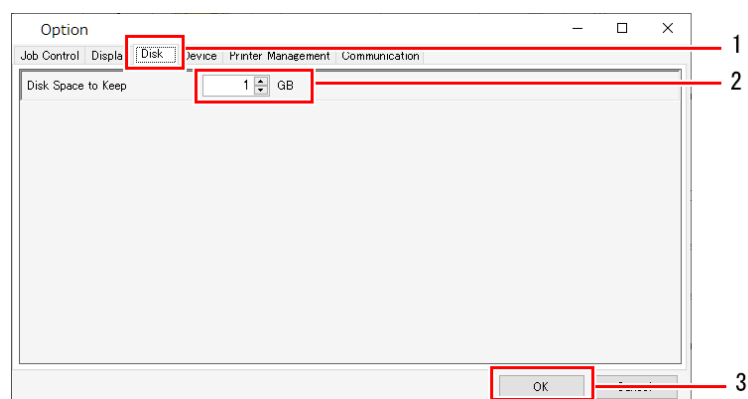
1 Select the [Disk] tab in the [Environments] - [Option] dialog.**2 Set a suitable value for [Disk Space to Keep].**

- Set the minimum free space on the hard disk where the work folder is located.
- Job execution is canceled if the space available drops below this setting.

3 Click [OK].

- Settings that have been changed will be applied after restarting RasterLink7.

- **Set the colorimeter**

1 Install the driver for the colorimeter to be used.**2 Connect the colorimeter to the ripping PC.**

3 Select the [Device] tab in the [Environments] - [Option] dialog.

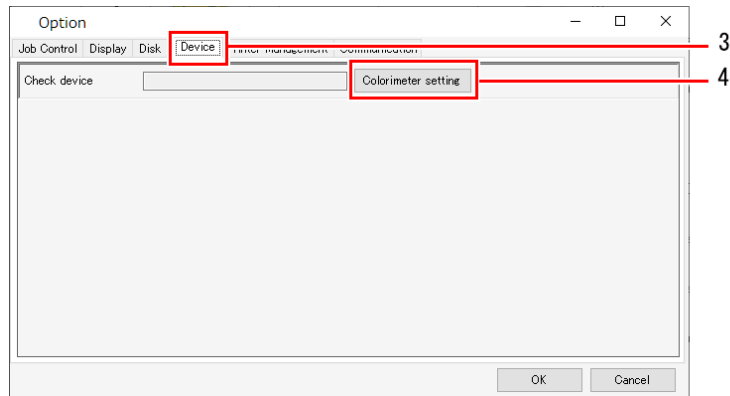

4 Click [Colorimeter setting].

- The [Setup] dialog appears.

5 Connect the colorimeter to the PC, then click [Check device].

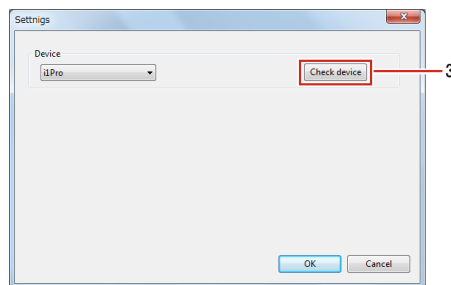

- The [Check device] dialog appears once the connection has been confirmed.

6 Click [OK].

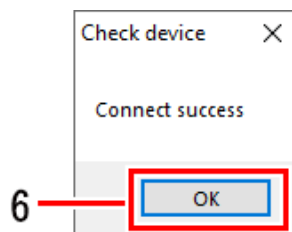

- Settings that have been changed will be applied after restarting RasterLink7.

● Set the interface

When performing ID cutting, set the CuttingLink connection information.

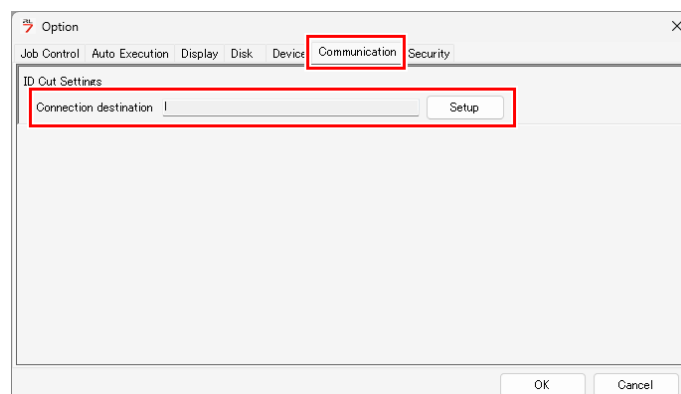

For more information, refer to the separate "ID Cut Guide".

● Set the security

If [Standard User] is selected while using RasterLink7 with an administrator account, RasterLink7 will launch with standard user permissions the next time.

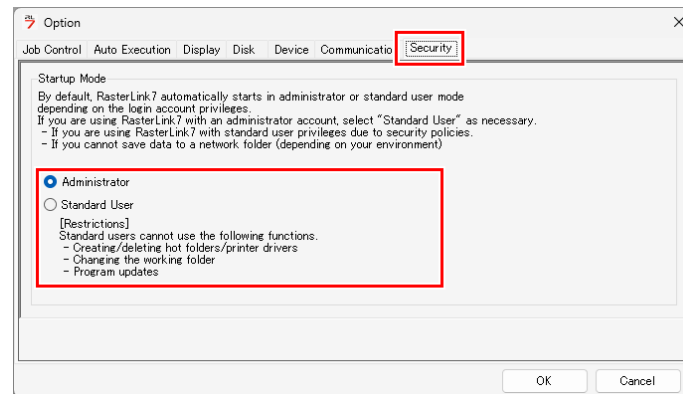

- If you are unsure of the user permissions for RasterLink7, check the area to the right of the version information in the upper-left corner of the RasterLink7 screen. The user permissions of the current user are displayed there.

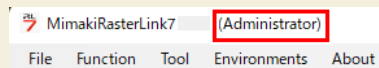

If there are restrictions such as those listed below, change the permissions before use.

- If security policies require using RasterLink7 with standard user permissions
- If your environment prevents saving data to network folders

Important! The following functions are not available to standard users. Switch to administrator permission to use them.

- Creates and deletes hot folders and printer drivers.
- Changes to the work folder
- RasterLink7 Update

2.4.3 Printer Management

Sets a printer and function icons.

Printer Management - Functions

[Printer Management] allows the following operations.

- Add a printer
- Check and edit printer settings
- Link a cutting device to a printer
- Delete a registered printer
- Setting a function icon

Printer Management - Screen Layout

● [Printer Management] dialog

Adds or deletes printers, edits the settings, and links cutting devices.

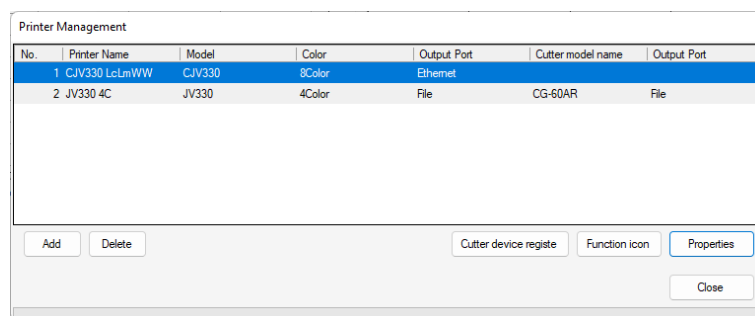

Printer Management - Operations

● Add a printer

1 Select [Environments] - [Printer Management] from the menu.

- The [Printer Management] dialog appears.

2 Click [Add].

- The [Printer Setting] dialog appears.

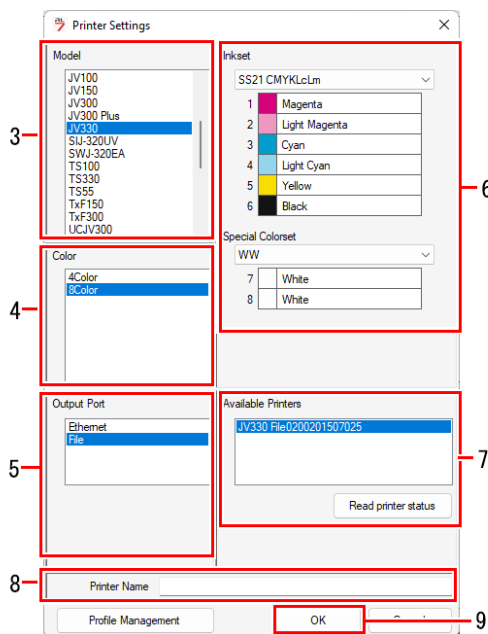

3 Select the printer model.

4 Select the printer color.

5 Select the output port type.

6 Select the inkset and special color set that are set in the printer.

7 If [USB2.0] or [Ethernet] is selected for [Output Port], select the printer to be connected from [Available Printers].

- Clicking [Read printer status] updates the [Available Printers] information.

8 Enter a suitable name.



- At least one device profile must have been installed for the printer to be registered. Before clicking [OK], click [Profile Management] to launch Profile Manager and check to confirm that a profile has been installed.

9 Click [OK].

- Printer addition and the settings are applied.

● Delete a registered printer

1 Select [Environments] - [Printer Management] from the menu.

- The [Printer Management] dialog appears.

2 Click the printer to be deleted.

3 Click [Delete].

- The selected printer will be deleted from the list.

Important! • Deleting a printer also deletes all of the jobs registered to that printer.

● Check and edit registered printer settings

1 Select [Environments] - [Printer Management] from the menu.

- The [Printer Management] dialog appears.

2 Click [Properties].

- The [Printer Setting] dialog appears.

● Setting a function icon

1 Select [Environments] - [Printer Management] from the menu.

- The [Printer Management] dialog appears.

2 Select the target printer, then click the function icon.

- The [Function icon setting] dialog appears.
- Only those function icons supported by the selected printer are displayed.

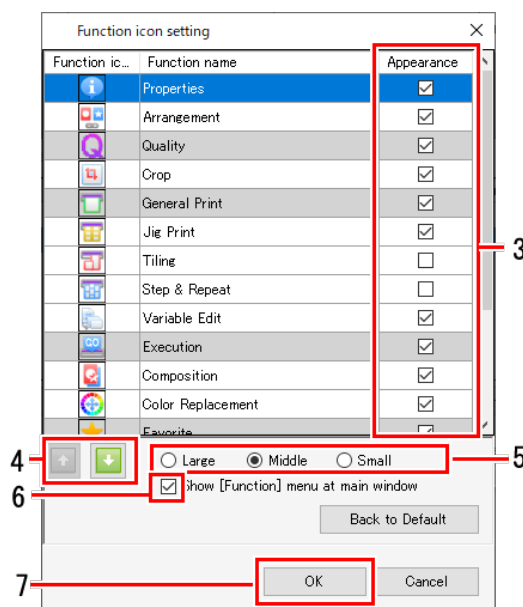

3 Select the [Appearance] check box.

- Selecting this displays the function icons and unselecting it hides the icons.
Note that the check box cannot be unselected if the function name background is gray.

4 Select a function, then click the  icon.

- The function icon display order is refreshed.

5 Select the function icon size.**6 Select or deselect the [Show [Function] menu at main window] check box.**

- Selecting this displays the menu bar and unselecting it hides the menu bar.

7 Click [OK].

- The function icon settings are applied.



- Clicking [Back to Default] restores the initial settings.

● Configure the cutting device settings

A cutting device that supports RasterLink7 can be linked to a registered printer.

Data can be sent directly from RasterLink7 to the linked cutting device.

For more information on how to link devices, refer to the separate "RasterLink7 Installation Guide".

2.4.4 Update notify settings...

Sets application update notifications.

Update notify settings... - Functions

[Update notify settings] allows the following operations.

- Receive RasterLink7 update information
- Set to receive device profile update information

● Conditions

Notifications cannot be received in the following cases.

- When the PC on which RasterLink7 is installed is not connected to the Internet
- When the RasterLink7 license has not been authenticated

Update notify settings - Screen Layout

● [Environments] - [Update notify settings] dialog

Sets notifications.

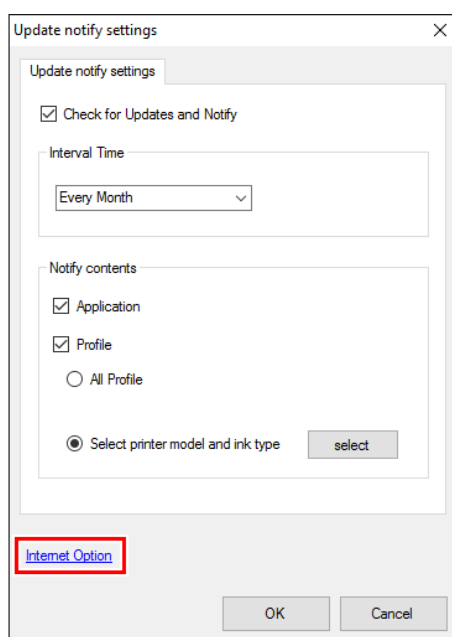

When using a proxy server

- Set the proxy server in [Internet Option].

Update notify settings - Operations

● Set to receive RasterLink7 update information

1 Select [Environments] - [Update notify settings] from the menu.

- The [Update notify settings] dialog appears.

2 Select the [Check for Updates and Notify] check box.

Important! Notifications cannot be used in the following cases, even when the [Check for Updates and Notify] check box is selected.

- When the PC is not connected to the Internet
- When the license has not been authenticated

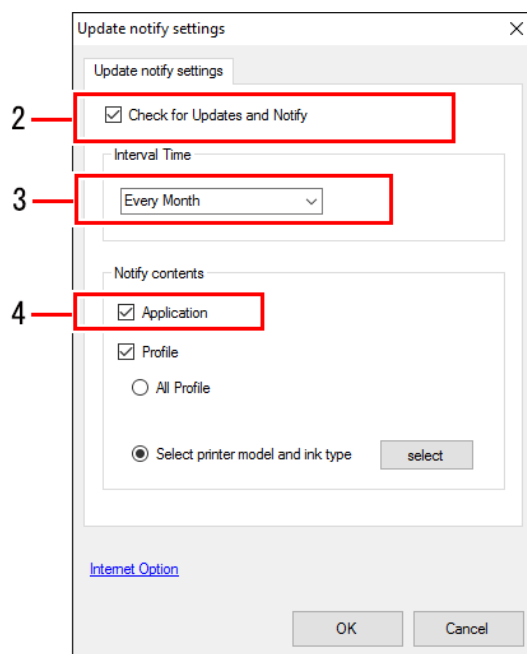

3 Select the interval for checking for new information from the [Interval Time] list.

- This can be selected as [Every Launch], [Every Day], [Every Week], or [Every Month].

4 Select the [Application] check box for [Notify contents].

5 Click [OK] to restart RasterLink7.

- This enables the notification settings.
- A dialog appears on startup if new information exists.
- Clicking [Yes, Sure] launches program updating.

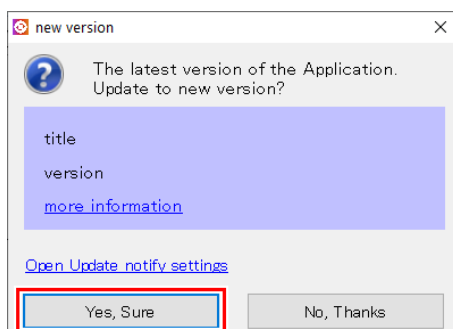

● Set to receive device profile update information

1 Select [Environments] - [Update notify settings] from the menu.

- The [Update notify settings] dialog appears.

2 Select the [Check for Updates and Notify] check box.

Important! Notifications cannot be used in the following cases, even when the [Check for Updates and Notify] check box is selected.

- When the PC is not connected to the Internet
- When the license has not been authenticated

3 Select the interval from the [Interval Time] list.

- This can be selected as [Every Launch], [Every Day], [Every Week], or [Every Month].

4 Select the [Profile] check box for [Notify contents].

5 Select the notification items.

- (1) [All Profiles]
- (2) [Select printer model and ink type]
 - Clicking [Setup] displays the [Update notify settings] dialog, allowing the printer and ink to be selected.

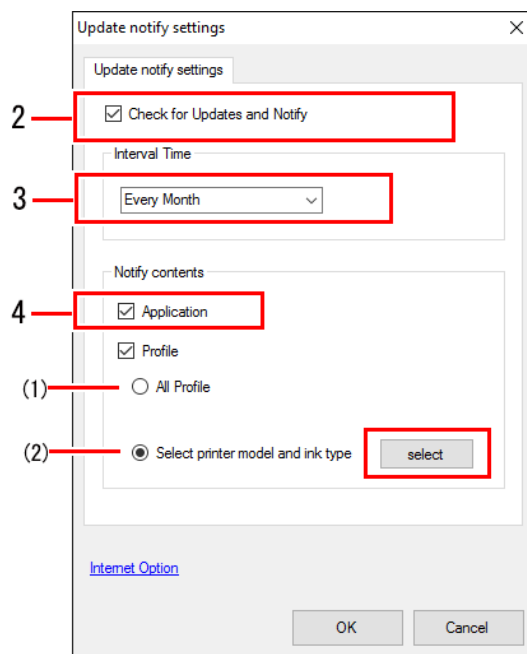

6 Click [OK] to restart RasterLink7.

- This enables the notification settings.
- A dialog appears on startup if new information exists.
- Clicking [Yes, Sure] launches Profile Manager and displays the profile download screen. Download the latest profile.

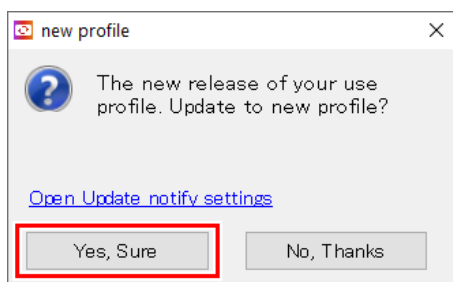

2.4.5 Setup Work Folder

Changes the work folder location.

Setup Work Folder - Functions

[Setup Work Folder] allows the following operations.

- Change the work folder location to a different disk

Setup Work Folder - Screen Layout

● [Environments] - [Setup work folder] dialog

Changes the work folder location.

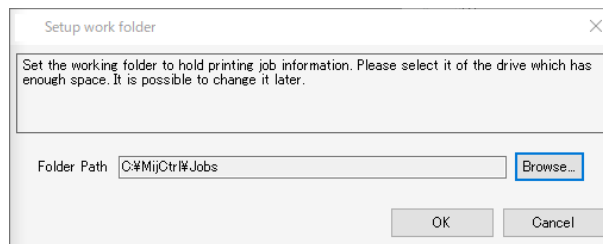

Setup Work Folder - Operations

● Change the work folder location to a different disk

1 Select [Environments] - [Setup work folder] from the menu.

- The [Setup work folder] dialog appears.

2 Click [Browse...] on the [Setup work folder] dialog.

- The folder browse dialog appears.

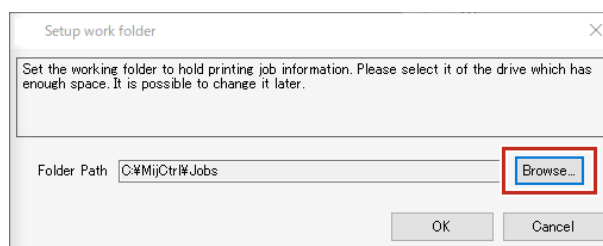

3 Select the work folder to be used, then click [OK].

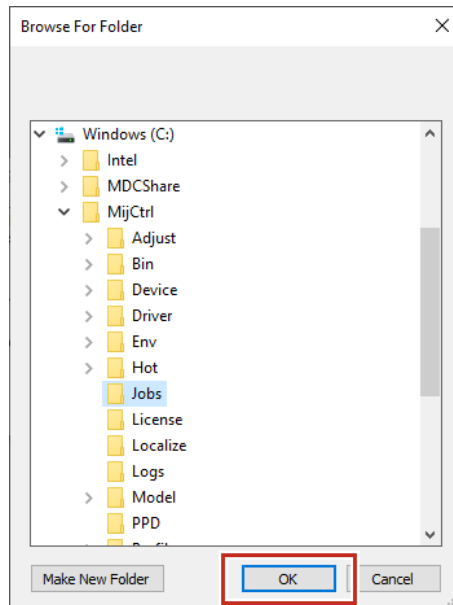

4 Click [OK] on the [Setup work folder] dialog.

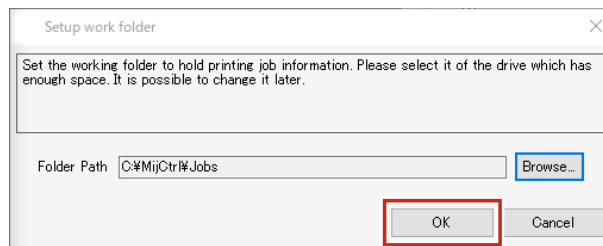

Important!

- Select a folder within a disk that has sufficient free space.
- The following folders cannot be selected as work folders.
 - The disk root folder
 - The RasterLink7 installation folder

5 The RasterLink7 exit confirmation dialog appears once the work folder has been changed. Click [OK].

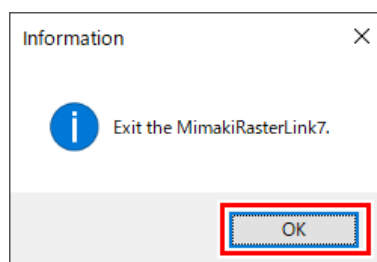

- RasterLink7 cannot be operated until the work folder changes are complete.
- RasterLink7 shuts down automatically.
- The new work folder can be used once RasterLink7 has been restarted.

2.5 About

2.5.1 Version

Selecting [About] from the menu displays the RasterLink7 serial key used for license authentication and other information.

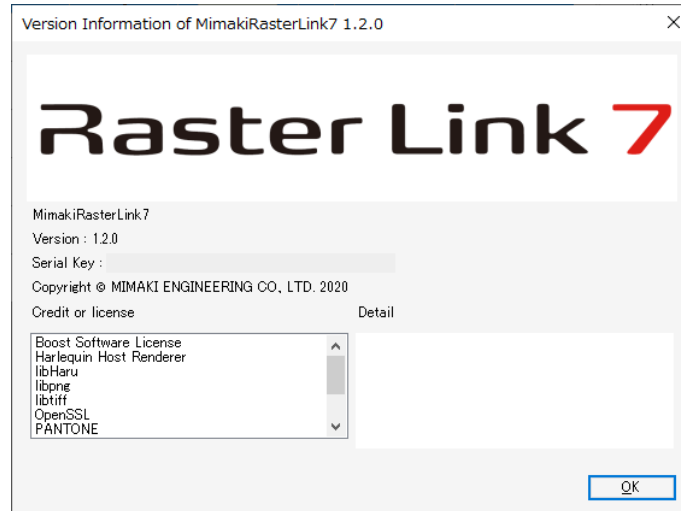

Chapter 3 Advanced Operations



This chapter

Explains the advanced printing operations available for individual printer models.

Overview of Advanced Operations	266	Twin Roll Printing	277
Operation Details.....	267	Multilayer Printing	284
Print & Cut.....	267	Braille Printing	286

3.1 Overview of Advanced Operations

RasterLink7 can be used to perform various advanced operations with compatible printers.

● Print & Cut

Outputs to a print & cut machine or a cutting device.

 ["Print & Cut"\(P. 267\)](#)

● Twin Roll Printing

Prints using two media rolls mounted on a single printer with the SJI-320UV or UJV55-320.

 ["Twin Roll Printing"\(P. 277\)](#)

● Multilayer Printing

This function prints multiple layers, utilizing the features of UV ink.

 ["Multilayer Printing"\(P. 284\)](#)

● Braille Printing

This function allows easy Braille printing simply by setting a spot color with RasterLinkTools for the created Braille data portion.

 ["Braille Printing"\(P. 286\)](#)



The following printing is also possible in addition to the operations described above:

- 2.5D printing
Machines using UV ink can be used to produce a three-dimensional effect by printing overlaid print layers.
Compatible printers:
JFX200EX, JFX600, UJF-7151plusII, UCJV330
For more information, refer to "2.5 TextureMaker Guide" for the corresponding printer.
- Kebab jig printing
Uses a Kebab system to print on the outer circumference of a cylinder.
For more information, refer to the corresponding Kebab system operation manual.

3.2 Operation Details

3.2.1 Print & Cut

Print & Cut - Overview

RasterLink7 allows cut data to be output to print & cut machines and cutting devices as follows:

Direct output to a print & cut machine

Print data and cut data can be output directly to a print & cut machine (CJV/UCJV Series). This section describes the settings.

Direct output to a cutting device

Cut data can be output directly to a cutting device by linking it to a printer registered in RasterLink7. This section describes the settings.

Output to a cutting device using CuttingLink

When printing data for cutting, ID data is printed at the same time, and the function for cutting based on this ID data is referred to as "ID Cut".

CuttingLink is the software used to manage cut data, link it to ID data, and output to a cutting device.

Typical ID printing

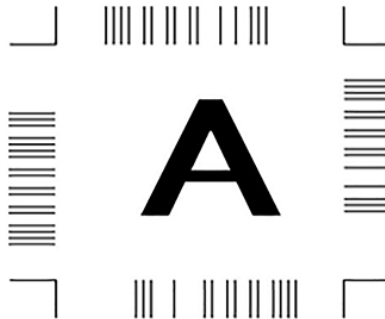

● Output method using CuttingLink

Data can be output using CuttingLink using either of the following two methods:

1. Send cut data from FineCut

This method is used when there are conditions or other parameters that can be set only in FineCut.

The output procedure is as follows:

1. Create print & cut data with ID data using FineCut.
2. Configure the various output settings using FineCut, then send to CuttingLink.
3. Print the created data using RasterLink7.
4. Load the printed media in the cutting device or print & cut machine, then scan the ID.
5. Acquire the cut data from CuttingLink, then cut the media.

For more information, refer to the separate "ID Cut Guide (Using FineCut)".

2. Send cut data from RasterLink7

This method is used when direct output from RasterLink7 is not supported. It also helps to prevent selection mistakes when using a print & cut machine, as there is no need to output the cutting data again when cutting after having removed the media from the printer, such as when cutting after post-processing such as lamination after printing.

The output procedure is as follows:

1. Add ID data to print & cut jobs using RasterLink7, then use [Cut after Print].
 - The print data is sent to the printer, and the cut data is sent to CuttingLink.
2. Load the printed media in the cutting device or print & cut machine, then scan the ID.
3. Acquire the cut data from CuttingLink, then cut the media.

For more information, refer to the separate "Print & Cut Machine ID Cut Guide".

Print & Cut - Functions

Outputs to a print & cut machine or a cutting device.

● image data

File format	ps, eps, pdf
Objects that can be cut	Vector data
Color of paths to be cut	The spot color prefixed by "CutContour"

Create an object for cutting in Adobe Illustrator

- Set a spot color for the cutting path on the object to be cut.
- Prefix the spot color name with "CutContour".
- Other characters can be included after "CutContour" (like CutContourCut1 and CutContourHalf). This enables multiple paths to be created with different cutting conditions.

Important!

- Single-byte alphanumeric characters must be used for the characters added after "CutContour".

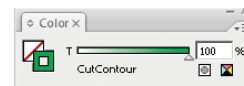

Add a path (line) with the special color name "CutContour" around the perimeter of the illustration as a cutting line.

3



- Using RasterLinkTools enables objects for cutting to be created easily in Adobe Illustrator/ CorelDRAW. For more information, refer to "Create a Cut Path Around an Object" in the separate "RasterLinkTools Guide".
- Please check  "The same location is cut twice or cut paths are not recognized." (P. 316) as a precaution when creating an object for cutting with Adobe Illustrator.

Important!

- When using the [Output to RasterLink] function for creating RasterLink cut data by using FineCut, select "Straight line" in [Approximation Type] on the [Plotter] tab in the [Plotter/User Setting] dialog of FineCut.

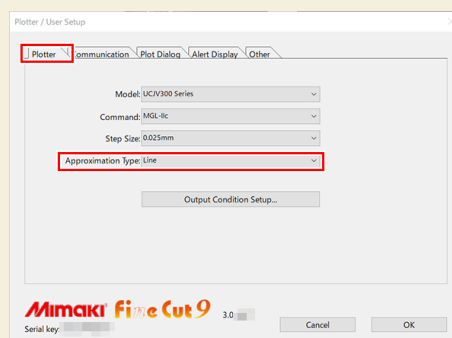

● Use in conjunction with other functions

Print & Cut can be used in conjunction with the following settings:

Function	Intercompatibility
[Arrange] ^{*1}	Yes
[Crop]	No
[Tiling]	No
[Step & Repeat]	No
[Special plate]	Yes
[Composite] ^{*2}	Yes
[Color Replacement]	Yes

*1. Arranged print & cut jobs

*2. Combination of print & cut and print jobs only

Important! • Print & Cut jobs for multi-page jobs are not supported.

Print & Cut - Screen Layout

● [General Print] - [Cut Edit] tab

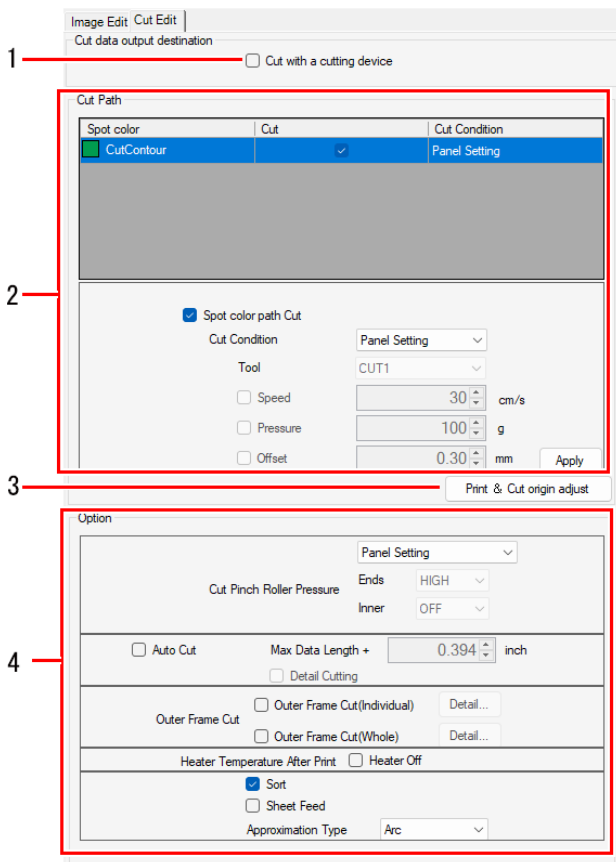

1. [Cut with a cutting device]

Selecting this outputs data to a cutting device if linked to the printer.

Selecting this outputs cut data to a cutting device if linked to a print & cut machine. If not selected, cut data is sent to the print & cut machine.

When linked to a printer, this will always be selected, and cannot be altered.

2. [Cut Path]

Sets the cutting method.

3. [Print & Cut origin adjust]

Prints & cuts an adjustment pattern to adjust the origin position.

4. [Option]

Sets the cutting options.

Print & Cut - Operations

● Set a print & cut job

Import print & cut data, then configure the various settings.

1 Import the print & cut data.

Arranged	Layered	Thumbnail	Job Name	Attribute
			kajik_cut.eps	Cut
			kajik_cut.eps	Color

- Importing one set of data automatically creates a job with two attributes (cut and color).
- The two jobs are automatically combined.
- The  icon indicating cutting is displayed on the thumbnail for the cut job.

2 When a cutting device is linked to a print & cut machine, use [Cut with a cutting device] to select the device to which cut data is output.

- The [Cut Path] and [Option] setting items on the [Cut Edit] tab will change depending on the output selection.

3 Select one spot color to be cut from the spot color list displayed for [Cut Path] on the [General Print] - [Cut Edit] tab.

- Different cutting methods can be set for each spot color.

4 Select the [Spot color path Cut] check box. (The default value is On)

- The path created using the selected spot color will be cut.

5 Select the conditions from the [Cut Condition] list.

- Selecting [User Definition] allows the cutting method to be set.

6 Sets the cutting method.

[Tool]	:	Select the cutter.
[Speed]	:	Set the cutting speed.
[Pressure]	:	Set the cutter pressure.
[Offset]	:	Correct the cutter center position.



- Refer to the operation manual for the corresponding printer for more information on cut conditions, as the appropriate values will vary depending on the media and cutter.

7 Set the cutting options in [Option]

- [Sort]
Selecting this sorts according to the optimum cutting order to reduce the cutting time.
- [Sheet Feed]
When selecting this, feed the media before cutting to check if the job can be cut.
- [Approximation Type]
Selects the method used for cutting curves.
 - [Straight Line] : Cuts by approximating curves to a series of short straight lines. This reduces quality but increases speed.
 - [Arc] : Cuts by approximating curves to a series of short arcs. This reduces quality but increases speed.

When outputting to a print & cut machine

- Cut Pinch Roller Pressure
Sets the pinch roller pressure during cutting.
 - [Auto Cut]
Selecting this automatically cuts the media once cutting has ended.
 - [Max Data Length +] : Sets the length from the end of the job to the position where it is to be cut.
 - [Detail Cutting] : Selecting this cuts jobs laid out as copies after each line printed.
 - [Outer Frame Cut]
Cuts the rectangle forming the job border or the rectangle of the entire job.
 - [Outer Frame Cut (Individual)] : Selecting this cuts a rectangle for each job.
 - [Outer Frame Cut (Whole)] : Selecting this cuts a rectangle for the entire job.
- Clicking [Detail] allows the cutting conditions to be set.

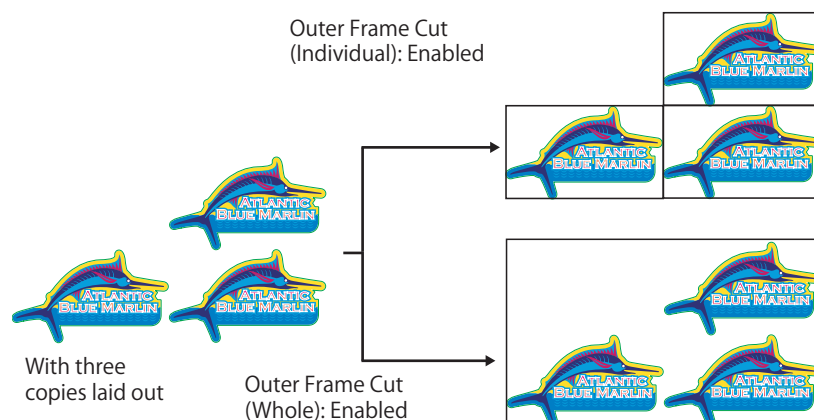

- [Heater Temperature After Print] (only for models equipped with a heater)
Selecting the [Heater Off] check box turns off the heater when cutting.



- Depending on the media, heat from the heaters may cause distortion, reducing the cutting accuracy. The heaters should be turned off in such cases.

When the output destination is a cut device

The settings vary depending on the cut device.

◆ CG-AR

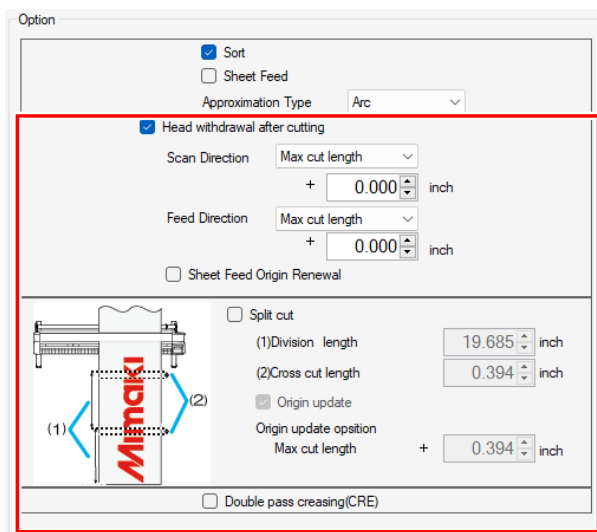

- **Head withdrawal after cutting**
Sets the head position after cutting has ended. Sets the position with respect to the reference position (select [Max cut length] or [Current origin]). Selecting [Update sheet feed direction origin] sets the position after head withdrawal to the origin. Selecting this when using continuous output with identical sheets helps to prevent mistakes involving cutting over the previous cutting position.



- When the [Split cut] check box is selected
The [Head withdrawal after cutting] option is disabled, and the head is withdrawn to the position set for [Origin update] in [Split cut].
- When two or more copies are set for [General Print] and [Individual registration marks] is selected
The [Head withdrawal after cutting] option is disabled, and [Head withdrawal after cutting] is not performed.

- **Split cut**
Sets split cutting in the feed direction. Split cutting helps to minimize cutting offsets due to the sheets meandering.
The design will be split and cut in sequence from the first sheet as shown in the following figure. Sheet feeding is performed for each split area.

Item	Explanation	Range	Default
Division length (mm)	Division length in the X direction	100 to 5000 (1 mm pitch)	500
Cross cut length (mm)	Length of duplicated cut range to eliminate uncut parts.	0 to 50 (1 mm pitch)	10
Origin update	Selecting this updates the origin after split cutting is complete.	On/Off	On
Origin update position (mm)	Position after origin update Must exceed the X direction maximum cut length.	0 to 51000 (1 mm pitch)	10

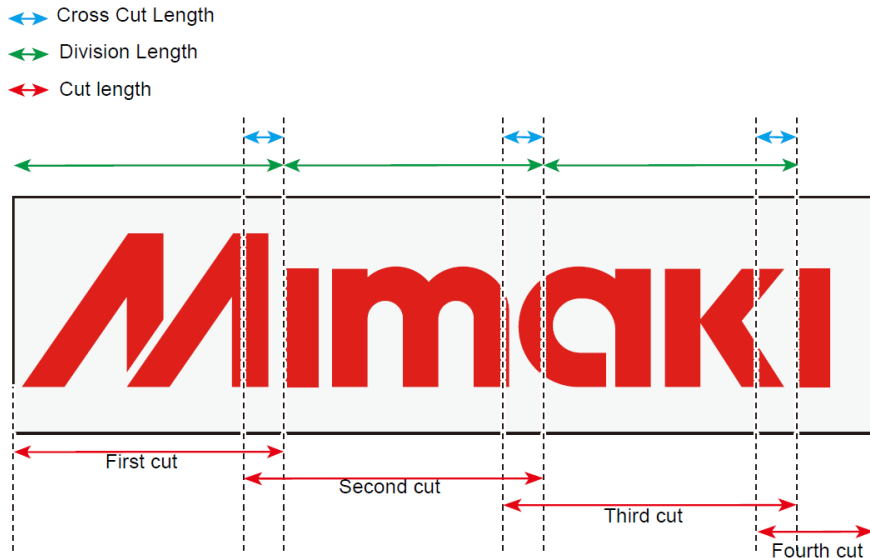

The operation will be as follows depending on the option settings:

- When the [Sort] check box is selected
Sorts by the design before splitting.
- When the [Sheet Feed] check box is selected
The entire media is fed before the first cut starts. Feeding is not performed for each individual split area.
- When the [Split cut] check box is selected
The [Head withdrawal after cutting] option is disabled, and the head is withdrawn to the position set for [Origin update] in [Split cut].



Note that [Split cut] and [Register Mark] in the [Image Edit] window cannot be enabled at the same time.

- When the [Split cut] is turned on, the register mark setting is automatically turned off.
- When the register mark setting is turned on, [Split cut] is automatically turned off.

- Double pass creasing(CRE)
If CRE (creasing) is selected using the tool for a cut path, that cut path will be output twice. Select this in cases where a crease is not formed with single creasing.

◆ CG-FXIIPlus

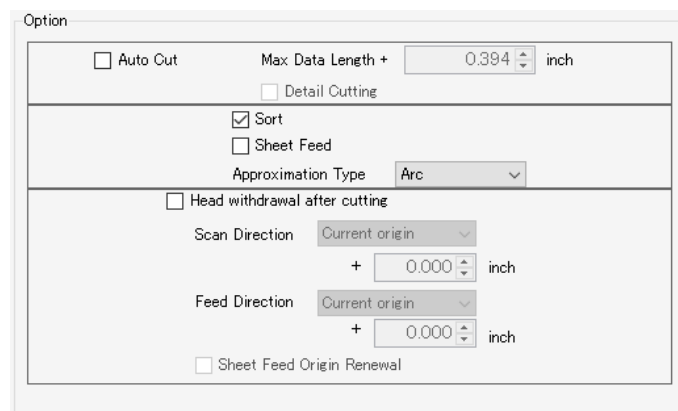

- [Auto Cut]
Selecting this automatically cuts the media once cutting has ended.

[Max Data Length +] : Sets the length from the end of the job to the position where it is to be cut.

[Detail Cutting] : Selecting this cuts jobs laid out as copies after each line printed.

- Head withdrawal after cutting
Sets the head position after cutting has ended. Sets the position with respect to the reference position (select [Max cut length] or [Current origin]). Selecting [Update sheet feed direction origin] sets the position after head withdrawal to the origin. Selecting this when using continuous output with identical sheets helps to prevent mistakes involving cutting over the previous cutting position.



- When two or more copies are set for [General Print] and [Individual registration marks] is selected
The [Head withdrawal after cutting] option is disabled, and [Head withdrawal after cutting] is not performed.

8 Click [Apply].

- The settings are applied.

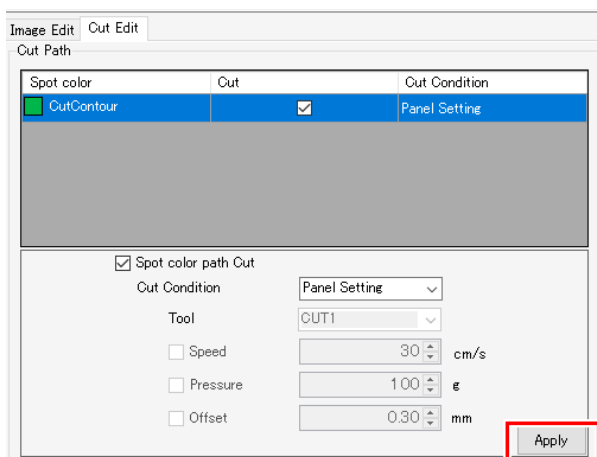

9 Select the [Execute] menu, then execute print & cut.



- For more information, refer to ["Execute"\(P. 127\)](#).

Important!

- Multiple images (jobs) cannot be cut consecutively. To cut consecutively, use ID cutting.
- When using RasterLink7 to output cut data, be sure to wait for cutting to end for the image (job) currently in progress. Cutting will not be performed correctly if the next cut job is output before cutting has ended.

● Print & cut origin adjustment (CJV300, CJV150, CJV300 Plus, UCJV300, CJV330, and UCJV330)

Adjusts the print & cut origin by printing and cutting an adjustment pattern.

1 Select a job in the [Job List].

2 Set the print & cut origin to the print conditions to be applied on the [Print Condition] screen.

3 Click [Print & Cut origin adjust] on the [General Print] - [Cut Edit] tab.

- The [Print & Cut origin adjust] dialog appears.

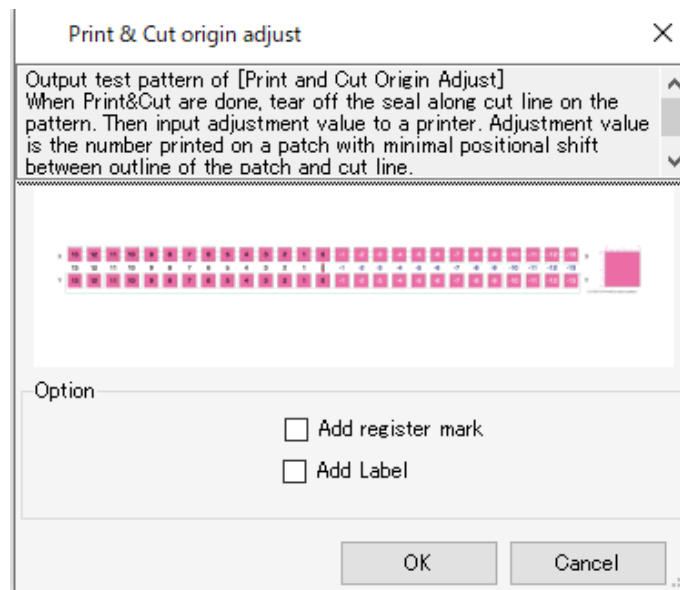

4 Set the register marks and labels.

- Selecting [Add register mark] adds register marks before printing.
- Selecting [Add label] adds information about the resolution, number of paths, and waveform at the top left of the adjustment pattern.

5 Click [OK].

- Printing and cutting of the adjustment pattern starts.

6 Check the adjustment pattern printed and cut, then enter the X and Y adjustment values on the printer input screen.

Important!

- If the resolution or paths have been altered after adjusting the print & cut origin, the print & cut origin must be readjusted.
- The print & cut origin adjustment job will be deleted from the job list automatically once the adjustment pattern has been printed and cut.
- The print & cut origin adjustment job will not be deleted automatically if the data is cleared or an error occurs while the adjustment pattern is being printed and cut. In such cases, jobs should be deleted manually.

3.2.2 Twin Roll Printing

Twin Roll Printing - Functions

Prints using two media rolls mounted at the same time with the SJI-320UV or UJV55-320.



- Twin roll printing with RasterLink7 refers to printing with two media rolls mounted at the same time.

Twin roll printing can be used in the following three ways:

- Copy a job and print on two rolls
(For operation details, refer to "Copy a job and print on two rolls"(P. 278))
- Arrange multiple jobs and print on two rolls
(For operation details, refer to "Arrange multiple jobs and print on to two rolls"(P. 280))
- Divide a job and print on two rolls
(For operation details, refer to "Divide a job and print on two rolls"(P. 281))

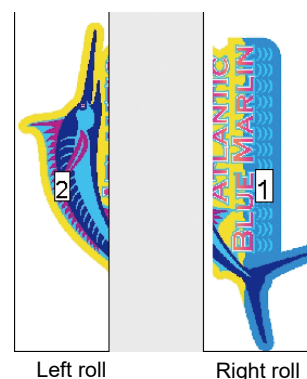
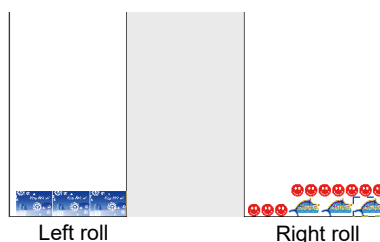
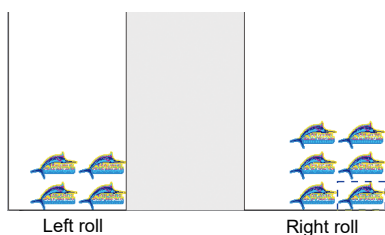

● Conditions

Model

Twin roll printing is possible with the SIJ-320UV and UJV55-320 only when the printer status can be acquired after mounting two media rolls.

Job

Twin roll printing cannot be used for jobs with the following conditions:

- Jobs with [Step & Repeat] enabled

Register marks

Register marks cannot be printed when twin roll printing is used for jobs with the following settings:

- When copies are set in [General Print] and [Each move] is selected
- When the [Add fotoba cut mark] check box is selected in [General Print]
- When [Arrange] is set

Twin Roll Printing - Screen Layout

The printer status acquisition can be checked on the [Printer] tab.

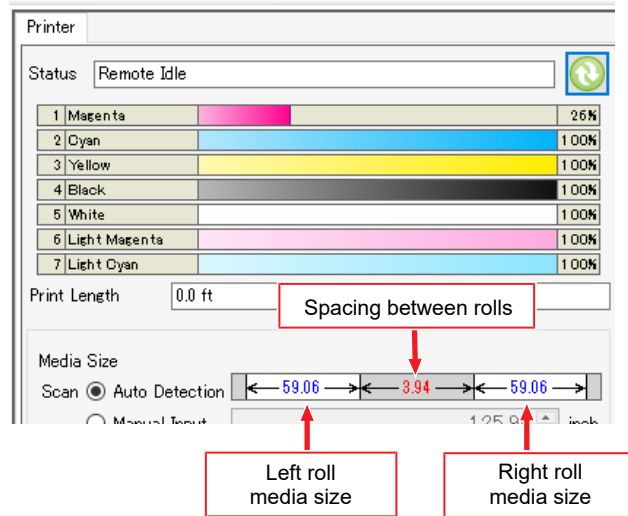

Twin Roll Printing - Operations

● Copy a job and print on two rolls

- 1 Select one job on the [Job List] tab.
- 2 Select [General Print].
- 3 Set the number of copies in [Copy] on the [Image Edit] tab.
 - The copied job is laid out on the right roll.

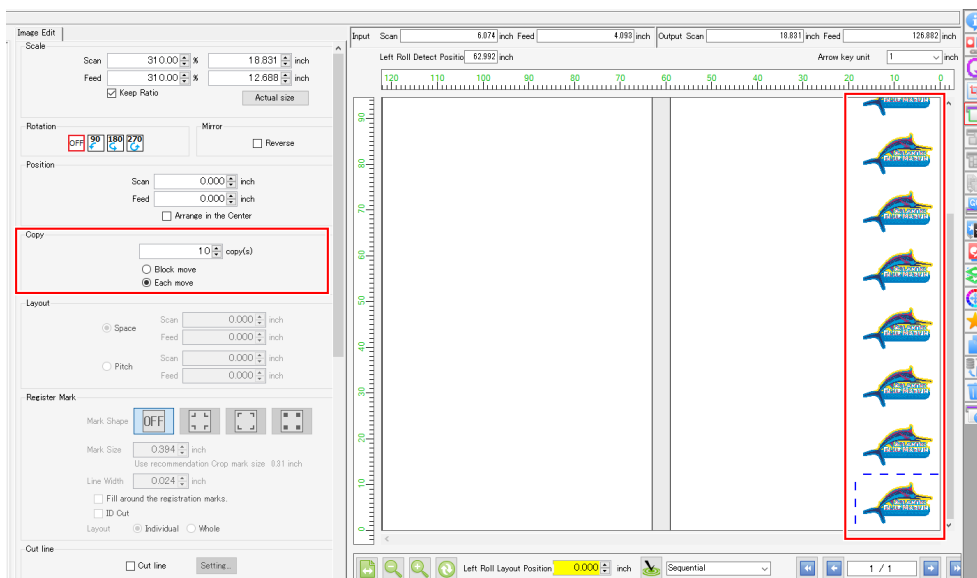

4 Check [Left Roll Detect Position], then enter the print origin for the left roll in [Left Roll Layout Position].

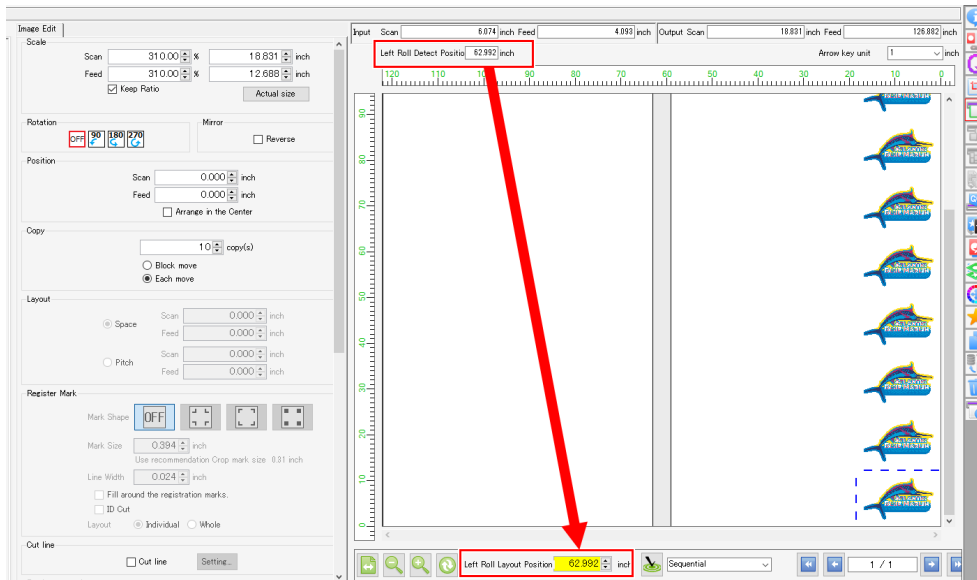

Important! • Enter the value above shown for [Left Roll Detect Position] in [Left Roll Layout Position].

5 Click the  icon.

6 Check that [Each move] is selected with using [Copy] on the [Image Edit] tab.

7 Click the  icon.

- The copied job is laid out on the left roll.

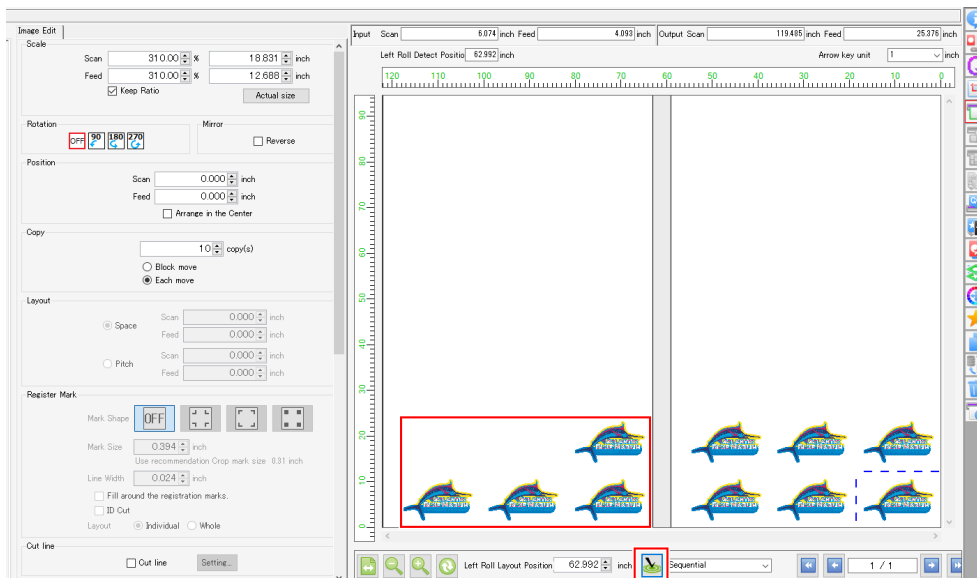

8 Use [Execute] to start printing.

- For more information, refer to  "Execute"(P. 127).

● Arrange multiple jobs and print on to two rolls

1 Select multiple jobs on the [Job List] tab.

2 Select [Arrange].

3 Click [Arrange].

- Multiple jobs are arranged.
For more information, refer to  "Arrange"(P. 49).

4 Select [General Print].

5 Check [Left Roll Detect Position], then enter the print origin for the left roll in [Left Roll Layout Position].

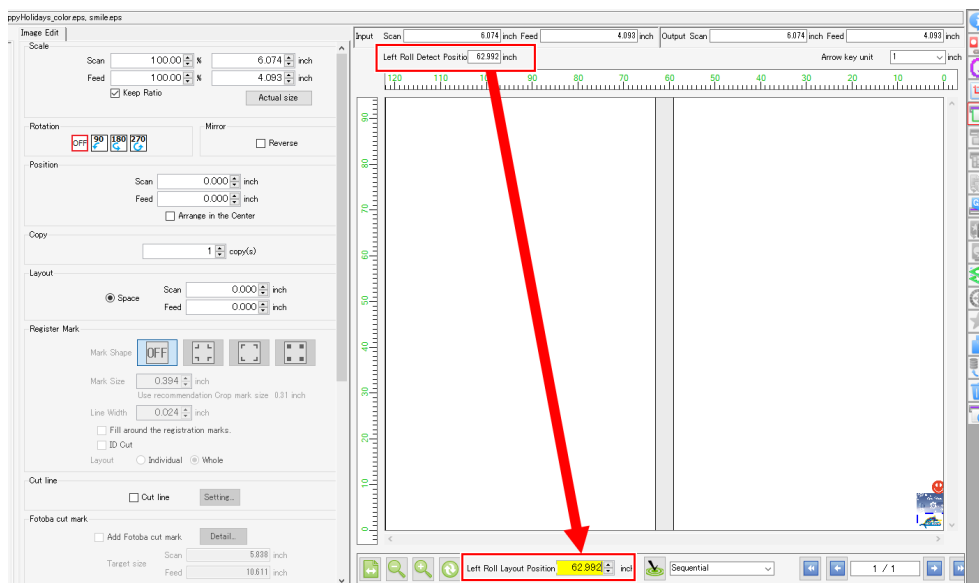

Important! • Enter the value above shown for [Left Roll Detect Position] in [Left Roll Layout Position].

6 Click the  icon.

- Odd-numbered jobs in the job list will be positioned on the right roll; even-numbered jobs will be positioned on the left roll.

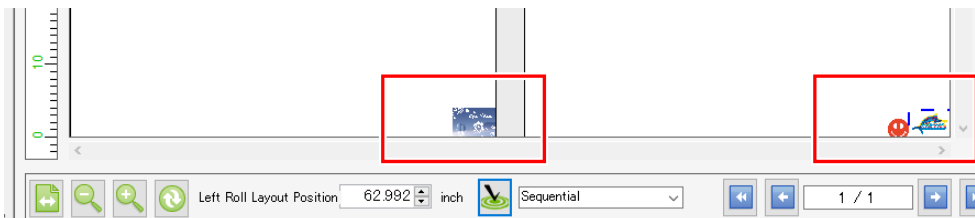

7 Select the job to be copied on the [Job List] tab.

8 Set the number of copies in [Copy] on the [Image Edit] tab.

- The copied jobs are laid out on the left and right rolls.
- At this stage, the jobs are laid on top of each other.

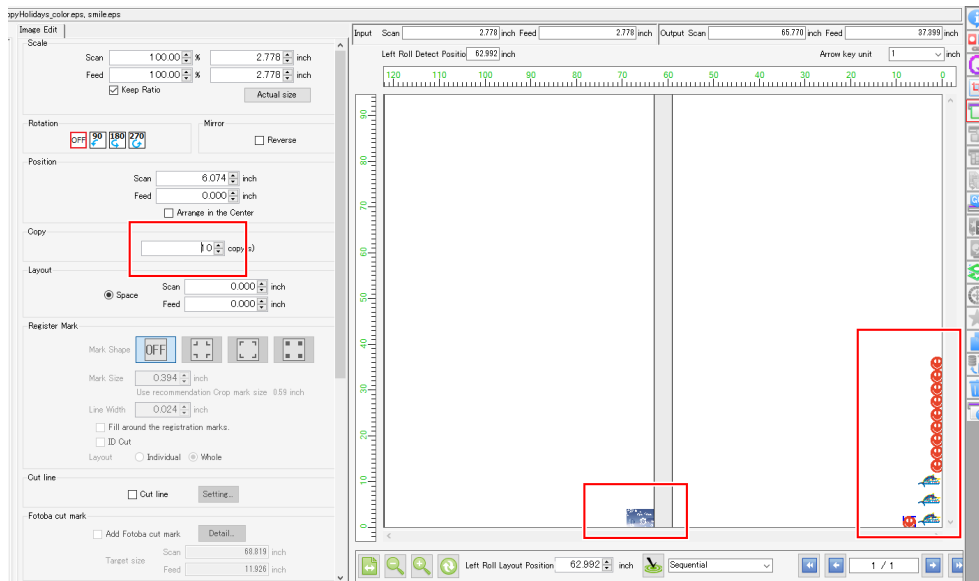

9 Click the [Execute] icon.

- This cancels the overlaid arrangement.

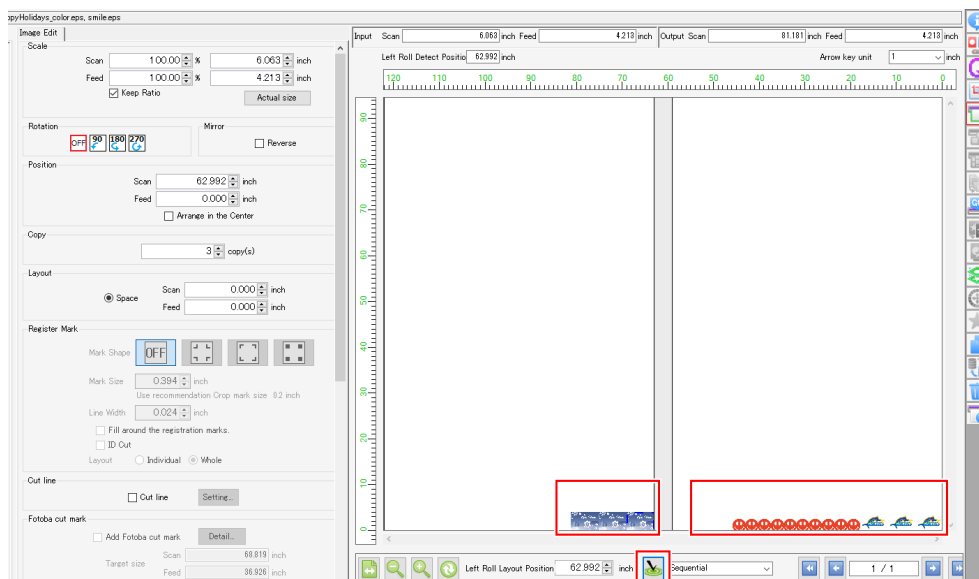

10 Use [Execute] to start printing.

- For more information, refer to "Execute"(P. 127).

● Divide a job and print on two rolls

1 Select one job on the [Job List] tab.

2 Select [Tiling].

3 Select the [Tiling Edit] check box on the [Divide Edit] tab.

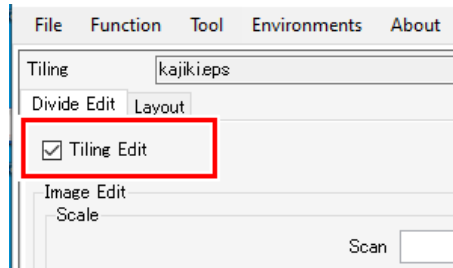

4 Select the [Free Location] check box on the [Layout] tab, then select [Nest] from the [Alignment Mode] list.

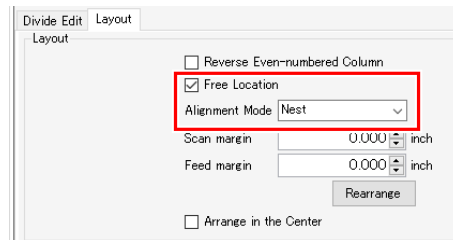

5 Check [Left Roll Detect Position], then enter the print origin for the left roll in [Left Roll Layout Position].

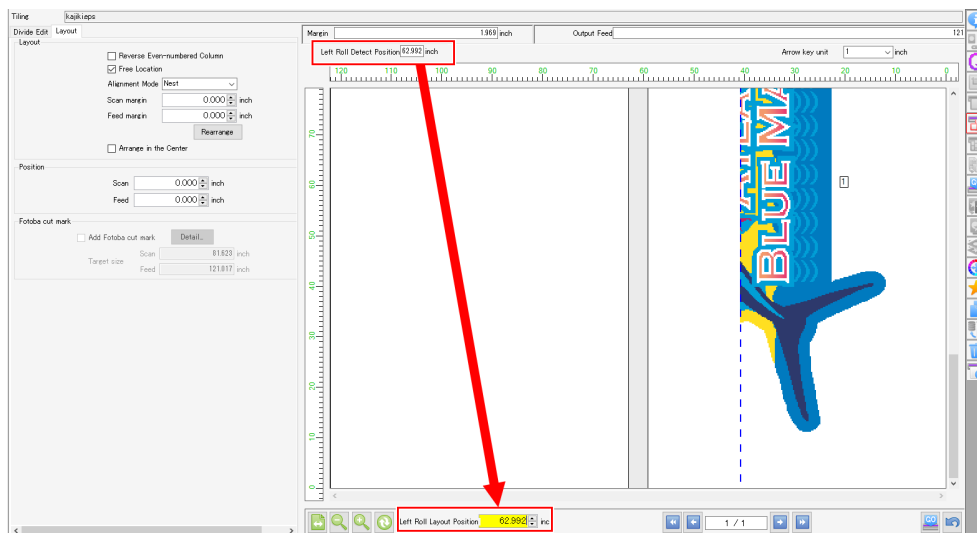

Important!

- Enter the value above shown for [Left Roll Detect Position] in [Left Roll Layout Position].

6 Click [Rearrange].

- Odd-numbered tiles of the job list are arranged on the "Right roll" and even-numbered tiles on the "Left roll".

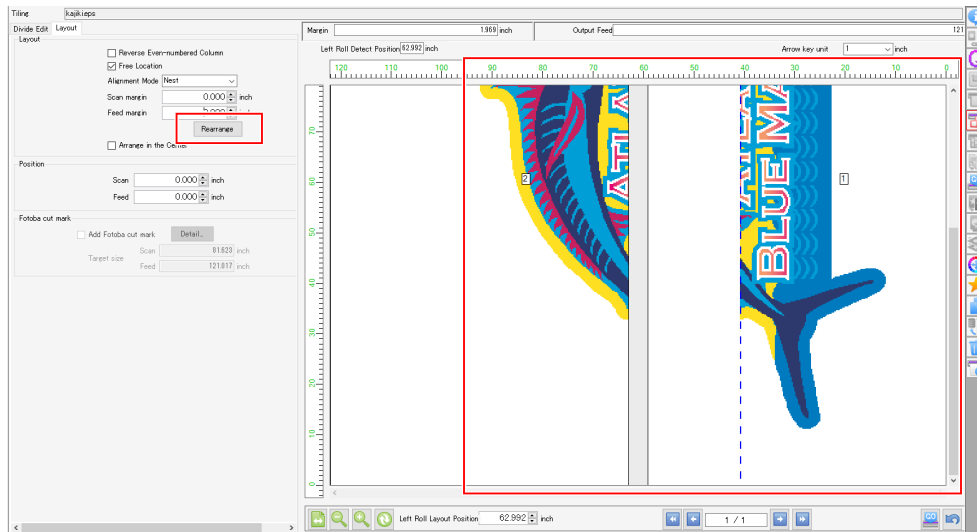

7 Use [Execute] to start printing.

- For more information, refer to  "Execute"(P. 127).

3.2.3 Multilayer Printing

Multilayer Printing - Functions

This function prints multiple layers, utilizing the features of UV ink. This allows new print styles not achievable with a single layer.

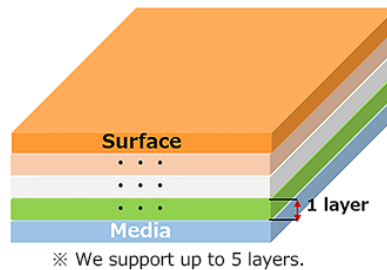

● Conditions

Compatible models: UCJV300, UCJV330

● Four-layer printing - Day&Night

Jobs are printed as four overlaid layers. This gives different results depending on whether the sheet is backlit or not backlit.

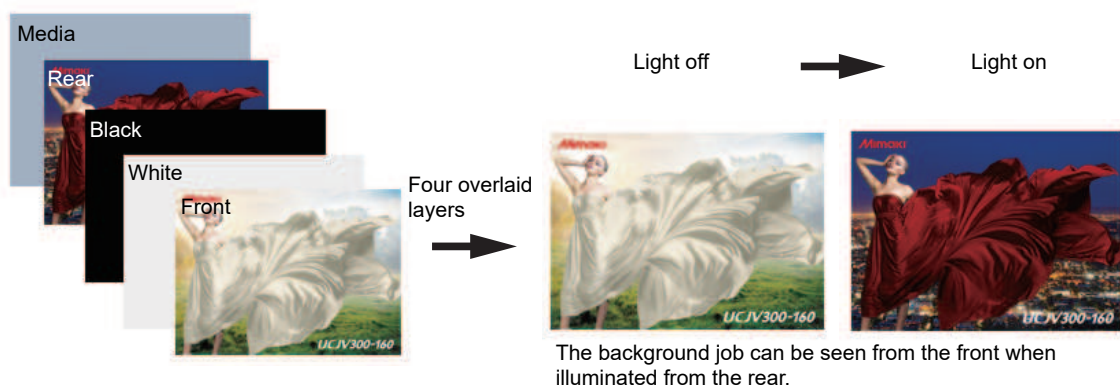

● Five-layer printing

Jobs are printed as five overlaid layers. This gives different results for a single media sheet depending on whether it is viewed from the front or the rear.

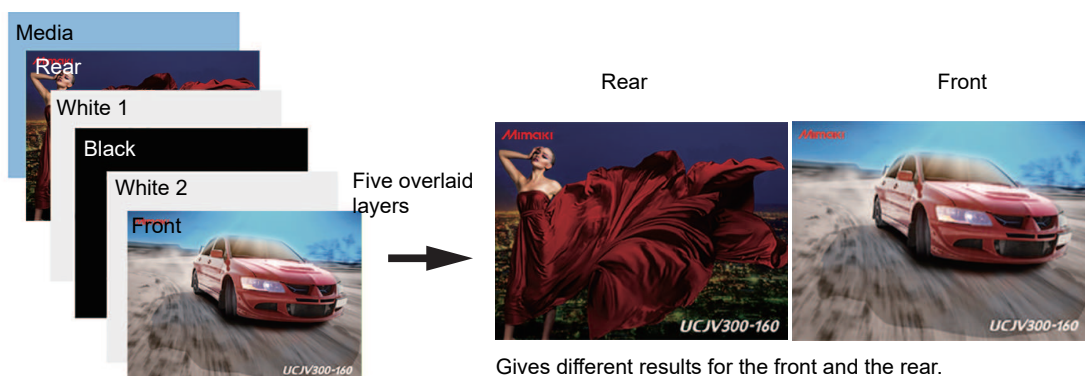

● Three-layer printing - Watermark printing (UCJV330)

Jobs are printed as three overlaid layers.

Printing three overlaid layers consisting of the color layer, white ink layer, and clear ink layer makes it possible to produce a printing effect known as "watermark printing" in which the clear ink area is visible through the front when illuminated from behind.

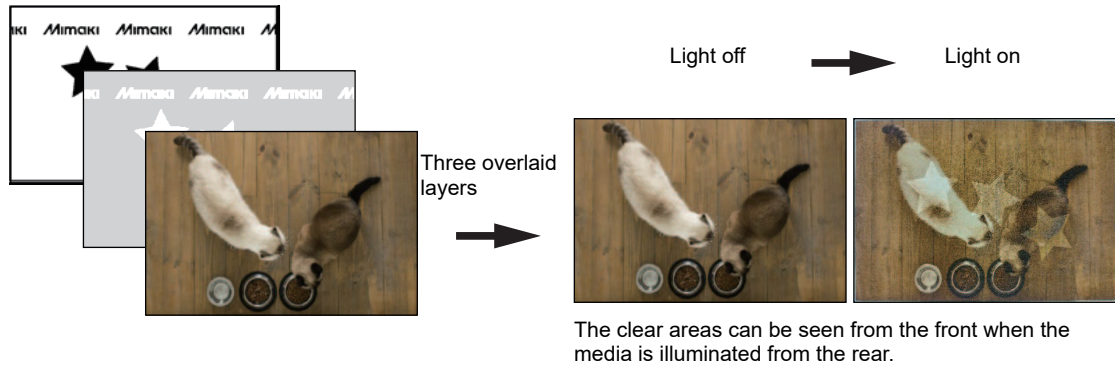

For more information on multilayer printing, refer to the "Multilayer Printing Guide" for the corresponding printer.

3.2.4 Braille Printing

Braille Printing - Functions

This function allows easy Braille printing simply by setting a spot color with RasterLinkTools for the created Braille data portion.

This function allows overlaid Braille printing on color jobs without the need to set the number of prints.

For more information on Braille printing, refer to the separate "Braille Printing Guide".

Chapter 4 Useful Functions



This chapter

Explains functions that are useful to know.

Job Name Search.....	288	FAQ Page Link.....	292
Display Job Name Search Function.....	288	Show the Printer FAQ Page.....	292
Search for a Job.....	289	Environment Backup/Restore.....	294
Search Using a Barcode Reader	290		

4.1 Job Name Search

Lets you search for jobs using the job name.
This is useful when a large number of jobs are registered.

4.1.1 Display Job Name Search Function

- 1 Select [Environments] - [Option] - [Display] tab.

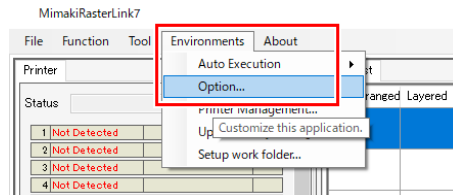

- 2 Select the [Display job name search function.] check box.

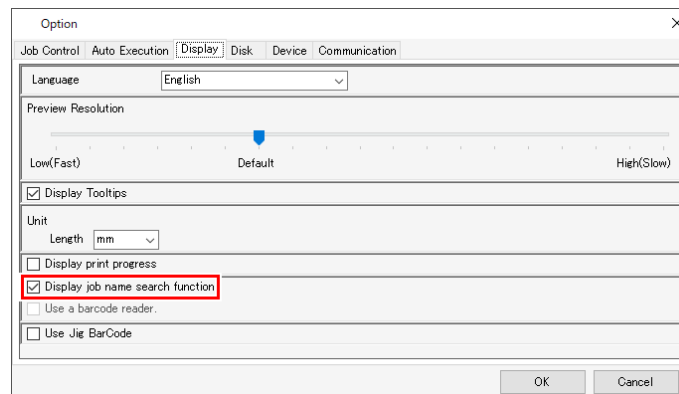

- 3 Restart RasterLink7.

- The job search is displayed.

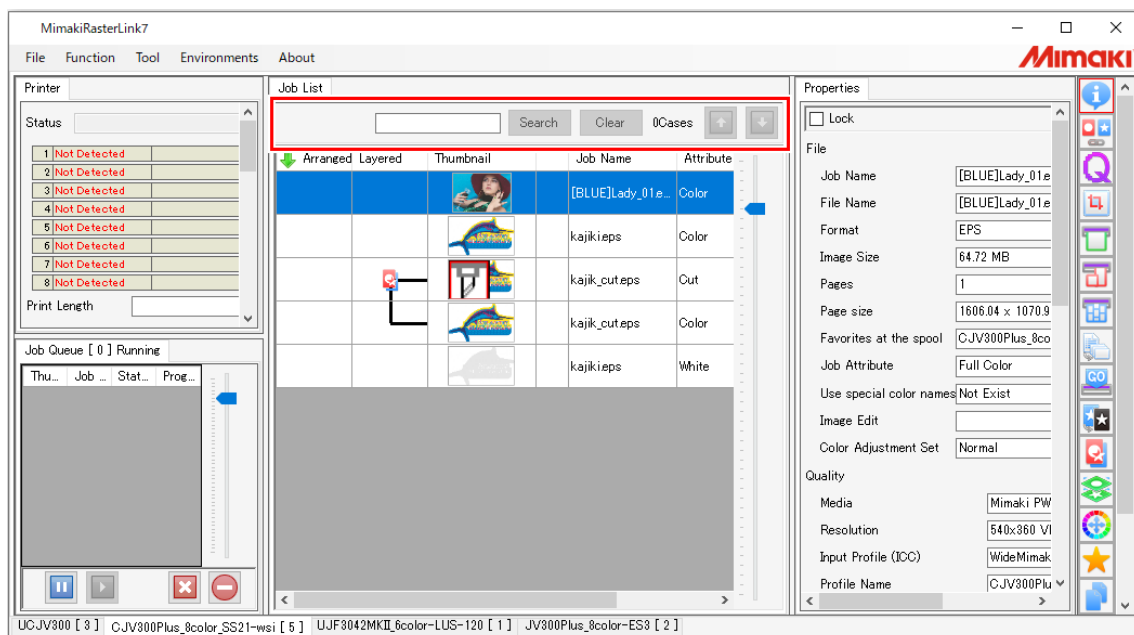

4.1.2 Search for a Job

Searches for jobs by job name.

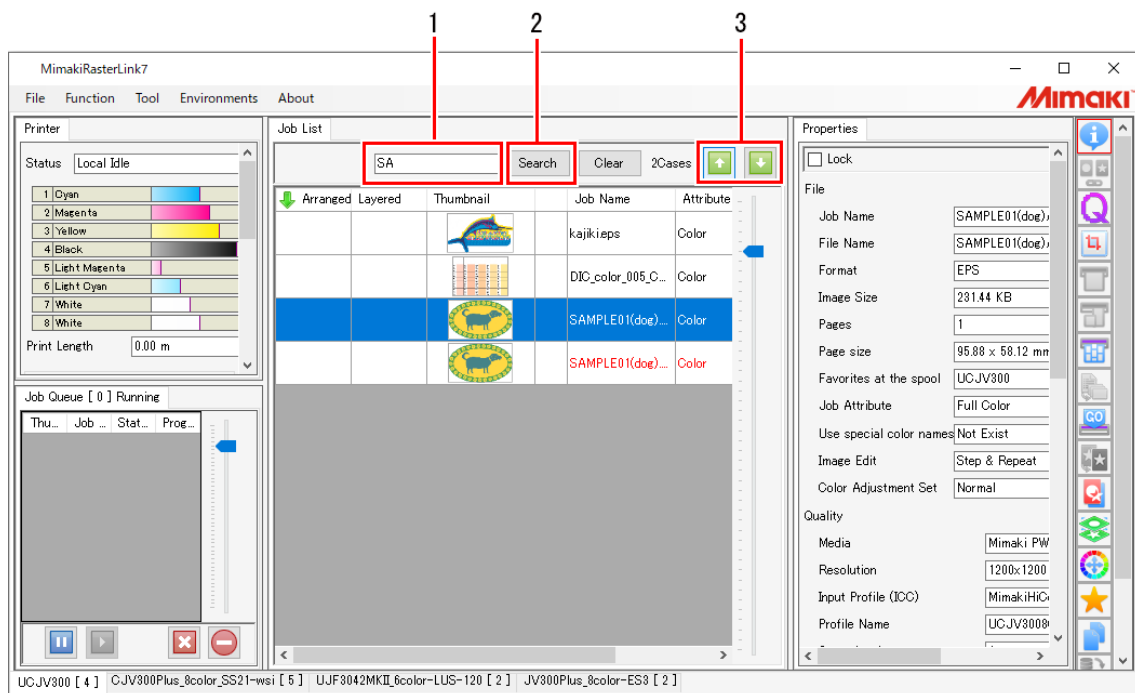

1 Enter any part of the job name in the job name input box.

- The function searches for initial matches and is case-sensitive.

2 Click [Search].

- Job names that match the search parameters are displayed in red.
- Job names that do not match the search parameters are displayed in black and cannot be selected.
- Clicking [Clear] cancels the search.

3 Click the [] icons, then select the required job.

4.1.3 Search Using a Barcode Reader

Job search parameters can be read in using a barcode reader for searching.

Important! Compatible barcode readers must satisfy the following specifications:

- Must feature a COM/RS-232C interface.
- Must be able to scan one-dimensional barcodes.
- Must be able to set an "ENTER" code for the keyboard end character.
- Recommended model: iTex ITL-3000/3000Plus
- Barcode type: CODE39 or CODE128

QR codes and a barcode reader capable of reading QR codes will be required for Japanese and other double-byte characters.



Important! • This function may not operate if RasterLink6Plus with this function enabled and RasterLink7 are running at the same time.
If this occurs, either exit RasterLink6Plus or disable this function with RasterLink6Plus.

1 Connect the barcode reader to the PC.

Important! • Before connecting the barcode reader, install the barcode reader driver on the PC on which RasterLink7 is installed.

2 Convert the job search parameters into a barcode.

- Use barcode conversion software.

Search condition [III2017]  
Convert to bar code (code 39) * I I I 2 0 1 7 *

3 Print the barcode created on documents such as work instructions.

4 Select [Environments] - [Option] - [Display] tab in RasterLink7.

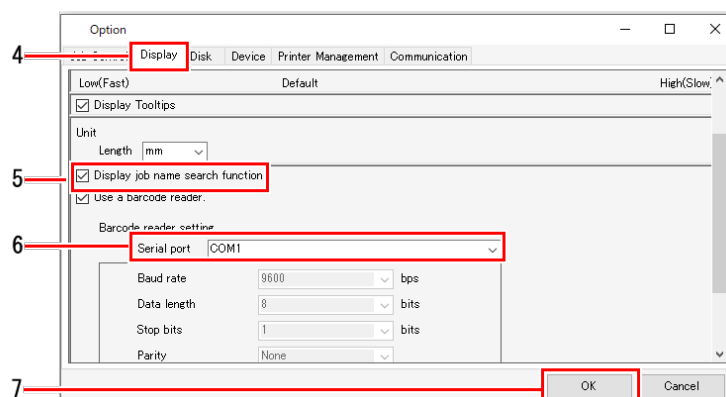

5 Select the [Use a barcode reader.] check box.

6 Select a barcode reader connected in [Serial port].

7 Click [OK].

8 Read in the barcode using the barcode reader.

- The corresponding job will be searched for in RasterLink7.

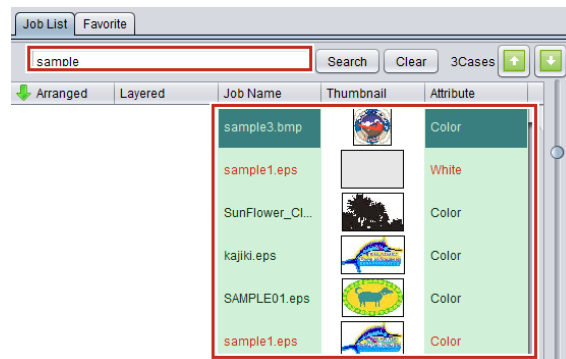

4.2 FAQ Page Link

If you are unsure about anything while using RasterLink7, refer to the FAQ page.



- FAQ stands for "frequently asked questions" and lists frequently asked questions together with their answers.

4.2.1 Show the Printer FAQ Page

If you are unsure about anything while using the printer, you can click the printer [?] icon to display the corresponding printer FAQ page in your web browser.

1 Select the printer by switching the printer on the screen.

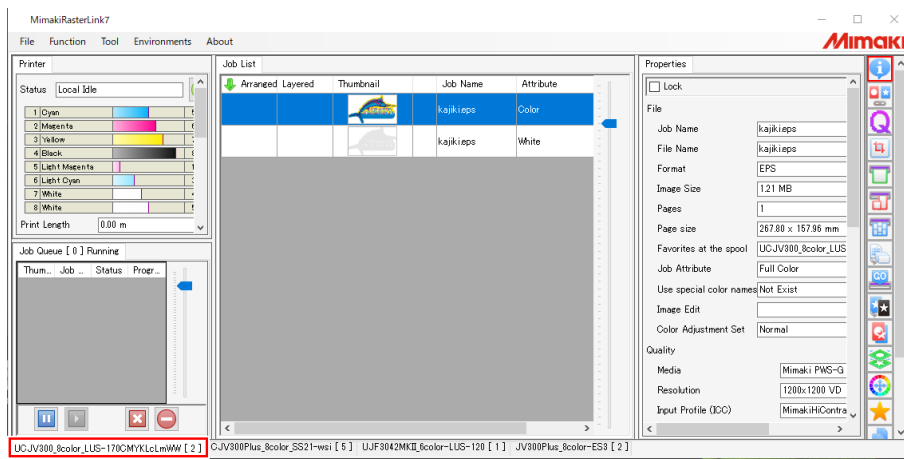

2 Click the  icon.

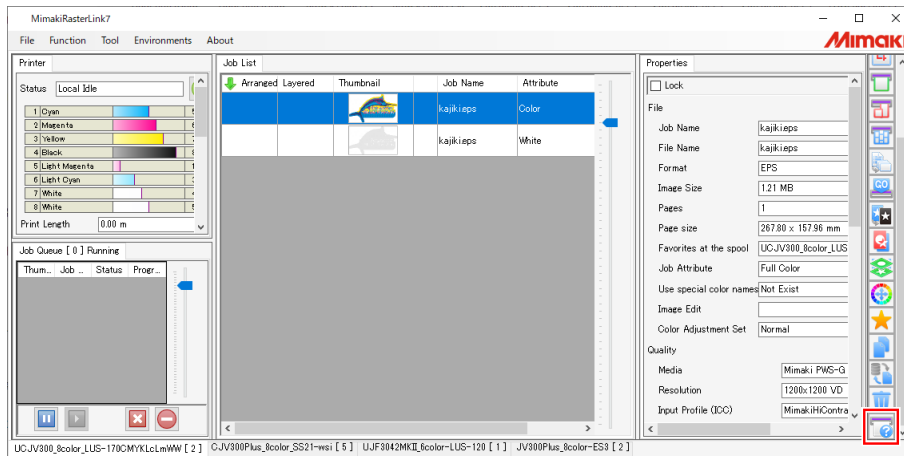

- The FAQ for the selected printer is displayed in your web browser.

4.3 Environment Backup/Restore

The following RasterLink7 settings can be saved in a file as a backup and restored in another environment.

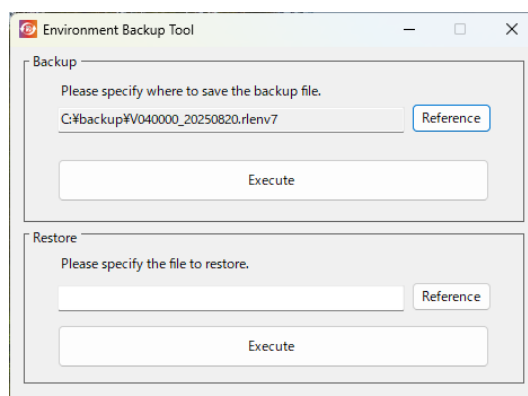

● List of settings that are backed up/restored

- Registered Device Information
- Favorite
- Printer/Hot Folder Information
- All Preset Files
- Color Adjustment
- Color Matching
- Device Adjustment
- Print Area
- Jig layout
- Profiles
- Device profiles
- Input profiles
- Calibration information created by calibration tool
- RasterLink7 option information

Important! This function does not back up or restore a job.

- To back up a job, use RasterLink7 backup function (☞ P. 185).
- The method of restoring a job varies depending on the restore destination.

(1) Restoring in the same model

→ Use RasterLink7 restore function (☞ P. 185).

(2) Restoring in a successor model

→ Use the job migration tool.

- The job migration tool can transfer a RasterLink6Plus job to RasterLink7.
- For more information on the tool, refer to the separate "Job Migration Tool Guide".

● Backup

1 If the RasterLink7 unit and Profile Manager have started up, terminate their operation.

2 Select [Mimaki RasterLink7] – [Environment Backup] from the Start menu.

- The [Environment Backup Tool] dialog appears.

3 Selects the backup destination.

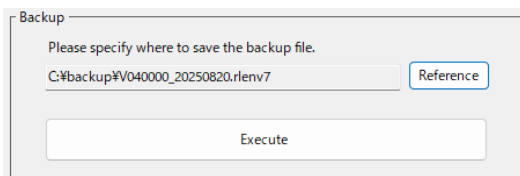

- Specify the file name to which the environment backup file is to be saved.
- Click [Browse...]. The [Save as a new file] dialog appears.

Important! About the environment backup file

- The file extension is "*.rlenv7".
- Save the file on a disk with sufficient storage space.

4 Click [Execute].

- When the backup operation is completed, the following message screen appears to notify that the backup file has been saved.



● Restore

Important! Be sure to read the following before restoring.

- **If a device is already registered at the restore destination, the contents of the backup file will be restored after all devices and jobs are deleted.**

If the existing data at the restore destination is needed, create a backup of the job by using the environment backup tool and RasterLink7 backup function before restoring.

1 If the RasterLink7 unit and Profile Manager have started up, terminate their operation.

2 Select [Mimaki RasterLink7] – [Environment Backup] from the Start menu.

- The [Environment Backup Tool] dialog appears.

3 Select the environment backup file.

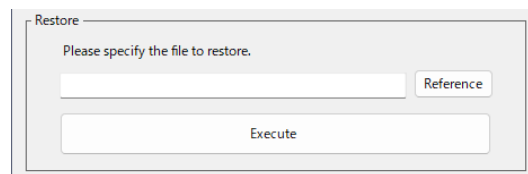

- Click [Browse...]. The [Restore File Path] dialog appears.
- Select the environment backup file for restoration, then click [Open].

4 Click [Execute].

- The restoration progress dialog appears.
- When the restoration is completed, the following message is displayed.

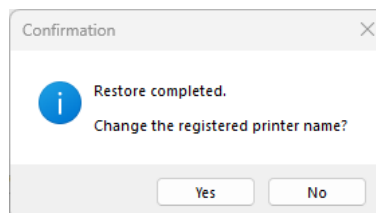

- Clicking [Yes] in the above dialog box displays the [Printer name change] dialog, allowing the printer name to be changed. Clicking [Back to Default] restores the original printer name.

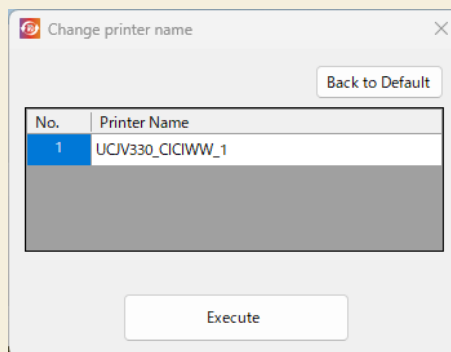

- Launch RasterLink7, then confirm that the environment has been restored.

Chapter 5 Troubleshooting



This chapter

Explains how to resolve problems that may arise and describes operation procedures that may be unclear.

Dealing with Error Messages	298	Macintosh Related Issues	320
PC-Related Installation Issues	306	Precautions when using hot folders	320
Unable to connect to the Internet when using tools.....	306	Ways to improve import speed when printing from design software.....	320
The screen display is faulty in RasterLink7.	306	Miscellaneous.....	321
RasterLink7 fails to start.....	306	Ways to improve ripping speed for images containing gradation objects	321
Precautions Regarding Design Software	307	How to improve streaking when printing with a printer equipped with clear or primer ink	322
Adobe Illustrator Related Issues	307	Composite is possible but cannot be printed	322

5.1 Dealing with Error Messages

Error message	Display conditions (causes)	Corrective action
Failed to load the execution module: [Execution module name]	A file required for executing RasterLink7 is corrupted.	Reinstall RasterLink7.
Failed to get the profile information.	The printer attribute information and installed profile information could not be acquired from the database file (Profile\Profile.mdb) when launching.	The profile database file may be corrupted. Reinstall RasterLink7.
There is no RGB input profile. Please install at least one profile.	An attempt was made to launch RasterLink7 with all RGB input profiles uninstalled in ProfileManager.	Install an RGB input profile using ProfileManager.
There is no CMYK input profile. Please install at least one profile.	An attempt was made to launch RasterLink7 with all CMYK input profiles uninstalled in ProfileManager.	Install a CMYK input profile using ProfileManager.
There is no full color device profile. Please install at least one profile. [Printer name: Inkset name]	The printer could not be registered when adding in [Printer Management], as none of the specified [Inkset] device profiles have been installed.	Install the device profile for the specified printer and inkset using ProfileManager.
	An attempt was made to launch RasterLink7 with all of the device profiles for [Inkset] at the time a printer was registered deleted using ProfileManager after registering a printer.	
The inkset information [Inkset discrimination] is not defined in the database.	Inkset information could not be identified when adding a printer in [Printer Management] due to incorrect specifications for [Model] or [Color].	When adding a printer in [Printer Management], select [Model] and [Color] settings from the lists that match the actual printer connected.
The Device profile specified in the Favorite setting [Favorite name] was not found. The settings were initialized. Please check the settings. The settings were initialized. Please check the settings.	An attempt was made to launch RasterLink7 with the device profiles associated with the favorite setting deleted using ProfileManager.	RasterLink7 automatically updated Device Profile Specification in [Favorite]. Check the favorite settings.
The device profile specified in the Job [Job name] was not found. The settings were initialized. Please check [Quality] settings. The settings were initialized. Please check [Quality] settings.	An attempt was made to launch RasterLink7 with the device profiles associated with the job deleted using ProfileManager.	RasterLink7 automatically updated Device Profile Specification for the job. Check the print settings.

Error message	Display conditions (causes)	Corrective action
Any available printer has not been specified.	An attempt was made to register a printer not connected in [Printer Management].	Check the connection to the printer.
The printer name has been already used.	An already registered [Printer Name] was specified when registering multiple printers in [Printer Management].	Enter a [Printer Name] not registered in [Printer Management] and a [Printer Name] not registered in [Control Panel] - [Hardware and Sound] - [Devices and Printers].
The selected available printer has been related to another printer (printer name).	[Available Printers] already specified as a registered printer was specified when registering multiple printers in [Printer Management].	Multiple printers cannot be registered for a single printer in [Printer Management].
The ink configuration had changed. Please register a new printer. Please register a new printer.	[Printer Management] - [Properties] - [OK] was clicked after changing the printer inkset or installed ink.	The [Inkset] information cannot be modified after a printer has been registered. Delete the original registered printer in [Printer Management], then add a new printer.
[MACHINE NAME] is duplicated for some printers. Please specify a unique [MACHINE NAME] for each printer by the operation panel.	A printer could not be registered when registering multiple printers in [Printer Management], as [MACHINE NAME] matched a printer that was already registered.	If two or more printers are connected via USB 2.0, specify a unique [MACHINE NAME] for each printer on the operation panel.
Could not stop Print Spooler. Could not start Print Spooler.	The Windows Print Spooler service could not be stopped or started when creating or deleting a hot folder.	The Windows Print Spooler service cannot currently be stopped or started. Note that antivirus software may prevent starting or stopping of the service program. Either temporarily uninstall the antivirus software or temporarily disable the virus detection function.
Cannot create the printer driver. [Printer driver name] Cannot create the printer. [Printer name] Cannot remove the printer driver. [Printer driver name] Cannot remove the printer. [Printer name]	The printer driver corresponding to a hot folder could not be created or deleted when attempting to create or delete the hot folder.	This may be due to a non-Mimaki printer. Delete the non-Mimaki printer in [Control Panel] - [Hardware and Sound] - [Devices and Printers].
	The printer driver could not be deleted when uninstalling RasterLink7.	If this error occurs when uninstalling RasterLink7, restart the PC, then delete the printer created by RasterLink7 in [Control Panel] - [Hardware and Sound] - [Devices and Printers].
The file name contains prohibited characters. Please change the file name.	The file could not be imported due to a problem with the file name.	Remove any prohibited characters such as punctuation and brackets.

Error message	Display conditions (causes)	Corrective action
File name is too long.	A file could not be accessed when attempting to import the file using the [File] - [Open] menu or by dragging and dropping because the full path for the file was too long.	File paths supported by Windows must not exceed 255 bytes. Path names may become long particularly for network drives. Copy the file to a local hard disk or USB memory drive before importing to RasterLink7.
The maximum number [***] of registered jobs has been exceeded. No more jobs can be registered. Please delete unnecessary jobs.	The maximum number of registered jobs (** jobs) was reached when attempting to import a file using [File] - [Open] or by dragging and dropping.	Please delete unnecessary jobs.
Cannot recognize the file format.	An attempt was made to import a file with an unsupported format.	Output the printer driver from the application [File] - [Print] menu.
Cannot get the image size.	The image size (media size) of the file imported could not be determined.	Output the printer driver from the application [File] - [Print] menu.
Cannot move the file from [source]to [destination].	This may occur when copying files from a client PC to a hot folder.	This occurs when the copied files are not released by the client PC. Restart the client PC.
PostScript Error	The RIP core detected an error when importing a file or when ripping.	Output the printer driver from the application [File] - [Print] menu.
		If [VMerror] or [limitcheck] occur, this indicates that the input image data is too complex. Simplify the data such as by rasterizing vector objects. If the image includes gradation objects, try disabling [Compatible gradation], and if it includes gradation meshes, try enabling [Gradation mesh print].
		If Hyper Job Threading is set to Level 3 or higher, the error may be caused by increased memory usage during RIP processing. Set the level to 2 or lower and retry the operation.
The operation cannot continue due to extremely insufficient memory.	There is very little available memory.	Restart RasterLink7.
		Select [Environments] - [Option] - [Display], and reduce [Preview Resolution].

Error message	Display conditions (causes)	Corrective action
Layout preview cannot be displayed because the media width is zero. Confirm the media width at [Printer Status]-[Media]. Confirm the media width at [Printer Status]-[Media].	The display was switched to the layout preview screen when no media was installed in the printer or when [Media Size] was set to [Manual Input: 0 mm].	Install the media in the printer, then reacquire the printer status.
		When entering [Fit to Media Width], be sure to specify a valid size.
The job is arranged out of the print area.	The job has been arranged completely outside the print area.	Arrange the job inside the print area.
The job is arranged out of range of the print area.	The job has been arranged partially outside the print area. Parts outside the area will not print.	If this presents a problem, make sure the job fits completely within the print area.
Any of print tiles is not specified.	No tiles have been selected for printing on the [Tiling] screen.	Set at least one tile using [Divide Edit] - [Print Order].
The size of top row tiles is too small. The size of left column tiles is too small. The size of some tiles is too small.	Tiles on the [Tiling] screen are smaller than the minimum size.	Check the tiling settings to ensure that the tiling size is larger than 1 inch (25.4 mm).
The size of some tiles is smaller than the overlap.	Tiles on the [Tiling] screen are smaller than the overlap size.	Set so that the tiling size is larger than the overlap size.
Different [Resolution] is specified in selected jobs.	An attempt was made to arrange multiple jobs with different resolutions or dot types (ND/VD) on the [Arrange] screen.	Make sure all of the jobs to be arranged have the same resolution and dot type on the [Print Condition] screen.
Different [Multilayer Print Type]s are specified in selected jobs.	An attempt was made to arrange multiple jobs with different multilayer print types on the [Arrange] screen.	Make sure all of the jobs to be arranged have the same multilayer print type on the [Layer] screen.
This Print Condition is different from the selected job. [first job name] Print Condition applies to all selected jobs in case of arrangement. OK?	An attempt was made to arrange multiple arrangeable jobs on the [Arrange] screen, but the print settings will be changed when arranged.	Select [No] if you do not wish to change the print settings.
Only a part of Composited / Arranged Job is not Deletable. If you wish to delete certain jobs, cancel the arrangement/ composition before deleting them.	An attempt was made on the [Delete] screen to delete some of the arranged jobs or some of the composite jobs.	Cancel the arrangement or composition before deleting the jobs.
Unexpected abort from RIP CORE. [PREVIEW]	An error occurred when reading the file.	Please read the file again.
Unexpected abort from RIP CORE. Restart RasterLink7. [RIP]	An error occurred during RIP processing.	Restart RasterLink7.

Error message	Display conditions (causes)	Corrective action
USB2 : Cannot open port (W). <Error details> USB2: Cannot open port (U). <Error details>	Cannot connect to the printer.	Check that the printer is turned on and that the printer is connected to the PC with a USB 2.0 cable.
USB2: [DATA CLEAR] function was performed by the printer.	[DATACLEAR] was clicked on the operation panel while printing was in progress.	Printing was aborted by the data clear operation. Printing cannot be resumed. If you wish to print the job again, print from the start.
	The media end was detected while printing was in progress.	Use the following methods. (1) Use a USB cable no longer than 3 m. (2) Use a USB hub. (3) Increase the number of USB interfaces.
	Data may be cleared unexpectedly if there is a communication problem with the USB interface while print data is being sent to the printer.	
DRV: An error has occurred during output (W). <Error details> DRV An error has occurred during output (O). <Error details>	A USB communication fault occurred while the print command was being sent to the printer.	This problem is more likely to occur when using non-recommended configurations such as those below. <ul style="list-style-type: none"> • When not using a PC containing a genuine Intel chipset • When using a USB cable extended using a repeater cable • When using a poor-quality USB cable (It is recommended that you use a Mimaki-recommended cable, available separately.)
		If you are already using the recommended setup, use the following methods. (1) Use a USB cable no longer than 3 m. (2) Use a USB hub. (3) Increase the number of USB interfaces.
Cannot connect to the printer with USB2.0 Hi-Speed mode. Check that the PC USB port, USB cable, and USB hub all support USB2.0.	Unable to connect in USB 2.0 Hi-Speed mode with the USB connection to the printer.	Check the USB 2.0 connection configuration.
Cannot get information for the calculation of the consumption of ink from the printer status.	An attempt was made to RIP while the printer was not connected. With certain Mimaki printer models, the printer must be connected to allow calculation of ink consumption.	Check the connection to the printer.
		If ink consumption does not need to be calculated, disable [Calculate Ink Consumption] in [Environments] - [Option] - [Job Control].

Error message	Display conditions (causes)	Corrective action
Cannot execute the Job because the media width is zero.	An attempt was made to print when no media was installed in the printer or when [Media Size] was set to [Manual Input: 0 mm].	Install the media in the printer, then reacquire the printer status.
		When entering [Fit to Media Width], be sure to set a valid size.
Cannot get information for multi layer print from the printer status. Please check the connection to the target printer. Please check the connection to the target printer.	An attempt was made to RIP a 3-layer print job while the printer was not connected.	Check the connection to the printer.
Unable to read the file. Either the file has been damaged or the file format is not valid. Either the file has been damaged or the file format is not valid.	A fault was detected in the input file during ripping.	Create the input file once more.
		This error also occurs when an alpha channel TIFF has been imported. Remove the alpha channel.
No restorable printer is registered (Model name).	A job could not be restored when restoring the backup job file on the [Backup] screen because the printer for the backed-up job is not registered.	Add a printer with the same conditions as the printer for the backed-up job in [Printer Management].
Cannot restore the file because it was backed up by newer version of RasterLink7. Please update RasterLink7 to [Version No.] or later.	An attempt was made to restore a job backed up with a version of RasterLink7 newer than the version of RasterLink7 installed when restoring a backup job file on the [Backup] screen.	Backup job files created using a newer version of RasterLink7 cannot be restored in an older version of RasterLink7. First update RasterLink7 to the specified version or later.
Cannot restore the job because the necessary profile has not been installed. Please exit RasterLink7 and install the following profile by ProfileManager and then restore the job again.	A job could not be restored when restoring the backup job file on the [Backup] screen because the profile used by the backup job is not installed.	Exit RasterLink7, then install the profile specified in ProfileManager in accordance with the message.
The free space of the working drive (Drive Name) is less than the setting size (## GB). Please delete unnecessary jobs or Ripped Data. Please delete unnecessary jobs or Ripped Data.	The free space on the HDD has fallen below the setting ([Environments] - [Option] - [Disk] - [Disk Space to Keep]).	Delete any unwanted jobs to free up space on the hard disk.
Cannot operate the job which is not ready.	Execution was set for a job being executed before execution was completed.	Wait until the job has been fully executed.
No operation applies to locked job.	An attempt was made to change the attributes of or to arrange, create a plate, compose, or delete a locked job.	Unlock in [Properties] before operating.

Error message	Display conditions (causes)	Corrective action
The changes were not saved because one or more jobs has been locked.	An attempt was made to select a locked job and open the Edit screen. Changes made on the Edit screen will not be saved when switching to a different screen.	If you wish to edit the job settings, unlock in [Properties].
The print condition in effect is not the recommended print condition (recommended drawing mode) of the profile. It may compromise quality if you continue with printing.	This appears when the print settings (number of paths, overprinting, print direction, fast printing) do not correspond to the recommended print settings for the profile and the UV irradiation value inside the profile cannot be obtained.	<ul style="list-style-type: none"> • Print using the recommended print settings. • Set the printer UV mode to a setting other than [Host].
		Selecting [Yes] aborts printing.
		Selecting [No] resumes printing and uses the printer UV irradiation setting.
The specification method of the printing page range is not suitable.	The page specification specified invalid characters, or the upper limit of input pages exceeded the total number of pages.	Set the page configuration while taking care not to use "-" twice and characters other than "-" or ";", or to specify an upper limit for the input pages exceeding the total number of pages.
Cannot composite jobs with different color set of device profile.	An attempt was made to combine jobs with different color sets. Jobs with different color sets cannot be combined.	Change to device profiles with the same color set.
Cannot Speed-priority Composite jobs with different device profile. Combine using [Quality].	Cannot Speed-priority Composite jobs with different device profile. Jobs were combined using the same conditions as for [Quality].	When combining using the same conditions as for [Speed], apply the same profile to all of the jobs to be combined, then combine again using [Speed].
Cannot Speed-priority Composite jobs with different resolutions. Combine using [Quality].	Cannot Speed-priority Composite jobs with different resolutions. Jobs were combined using the same conditions as for [Quality].	When combining using the same conditions as for [Speed], set the same resolution for all of the jobs to be combined, then combine again using [Speed].
Server is busy, so cannot connect to the database. Please wait for a while and try again. Please wait for a while and try again.	An attempt was made to activate a license while the server was undergoing maintenance.	Wait a while and try again later.
Re-activate is needed.	The license may not have been activated.	Deactivate the license as described in the operation manual, then repeat license activation.
The PC configuration has been changed after your activation.	If the license was activated via a LAN cable connection, but RasterLink7 was started using a wireless LAN connection	<ol style="list-style-type: none"> 1. Restore to the same configuration as at the time of license activation before starting. Restore the network connection method (LAN

Error message	Display conditions (causes)	Corrective action
	<p>If the license was activated via a wireless LAN connection, but RasterLink7 was started using a LAN cable connection</p> <p>Because the PC configuration changed (such as motherboard replacement)</p>	<p>cable or wireless LAN connection) motherboard to the original configuration.</p> <p>2. Deactivate the license, repeat license activation, then start RasterLink7. If not connected to the Internet, deactivate the proxy license.</p>
Error occurred during activation.	<p>Errors may occur with the following network connections:</p> <ul style="list-style-type: none"> • PPP network adapter (such as USB data communication terminals) • USB connection network adapter (such as USB wireless LAN adapters) 	Connect using a LAN cable for license activation. Do not use PPP connection or USB connection network adapters.
This serial key is already used on another PC.	This error occurs if a serial key already used for activation is reused without first deactivating the license. (For example, if you attempt to install RasterLink7 and activate the license while another activated PC already exists)	Deactivate the license on the activated PC, then activate the license on the new PC.
An overflow error occurred.	This occurs if the image size for outline extraction in RasterLinkTools is too large.	If outline extraction is not possible, reduce the image size.
Unexpected problem occurred because parameter file was corrupted. Please restart Mimaki RasterLink 7.	Part of the job file is corrupted.	Delete all folders starting with "S01" under the MijCtrl\Jobs\ number folder.
	The configuration file for the environment information is corrupted.	Reinstall RasterLink7.
RasterLink7 cannot be started because Mimaki Driver is unavailable or not installed. If Mimaki Driver is not installed, please install v5.0.0 or later. If it is installed, restart your PC and then start RasterLink7.	This occurs when Mimaki Driver is not running.	<p>Try the following steps in order:</p> <ol style="list-style-type: none"> 1. Install Mimaki Driver, then restart the PC. 2. Enable unitMDC.exe in the startup settings. 3. Manually start the driver by double-clicking the following file. "C:\Program Files\Mimaki\MimakiDeviceController\unitMDC.exe"

5.2 PC-Related Installation Issues

5.2.1 Unable to connect to the Internet when using tools

If you are using security software that includes a firewall feature, connections to a network (Internet) may be blocked when using tools for license activation, program updating, and profile updating. Most security software will prompt the user for permission to connect when the software connects to a network for the first time.

Be sure to allow the connection if prompted to confirm for the first time for license activation, program updating, and profile updating.

If you accidentally refuse the connection, refer to the manual for the security software in use and allow network connections for the following files:

- RasterLink7 installation drive\ RsLink7thWeb\Bin\AppWebcLicense.exe
- RasterLink7 installation drive\ RsLink7thWeb\Bin\AppWebcNotify.exe
- RasterLink7 installation drive\ RsLink7thWeb\Bin\AppWebcProfile.exe
- RasterLink7 installation drive\ RsLink7thWeb\Bin\AppWebcProgram.exe

5.2.2 The screen display is faulty in RasterLink7.

The following problems may occur with the screen display in RasterLink7:

- Parts of the previous tab display remain when selecting other tabs.
- The preview is corrupted.
- The screen display may become corrupted or the PC may freeze if RasterLink7 runs for extended periods.

Check the following details if problems like this occur:

- Update the graphic board driver to the latest version.
For more information on how to update the graphic board driver, refer to the manual for your PC or graphic board.

5.2.3 RasterLink7 fails to start.

RasterLink7 may sometimes fail to start even when the RasterLink7 icon on the desktop is double-clicked.

Check the following details if problems like this occur:

- Launch RasterLink7 from the Windows Start menu.

5.3 Precautions Regarding Design Software

5.3.1 Adobe Illustrator Related Issues

Transparency effects and drop shadows

Data with transparency effects applied may result in noticeable jagged edges when enlarged and printed with RasterLink7.

If problems like this occur, set [Document Setup] in Adobe Illustrator as follows.

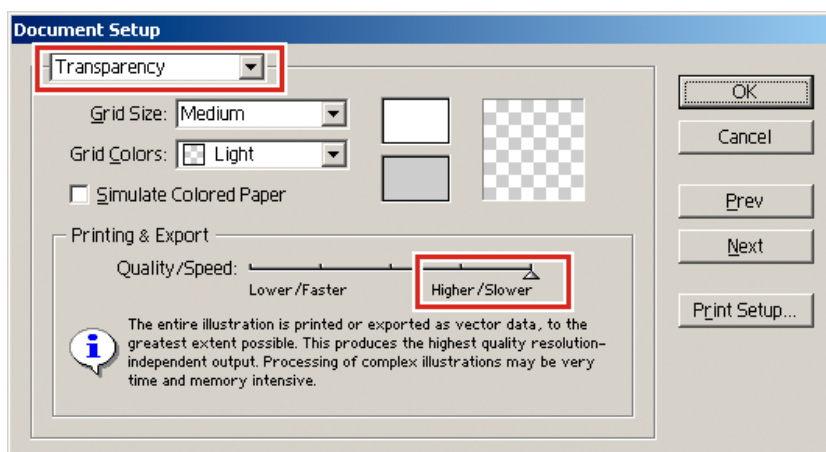

If the Drop Shadow command is used, the color around the object with a drop shadow added will differ from other colors.

Set the same [Color Matching Method] for [Illustration] and [Image] in RasterLink7.



Text does not print correctly

If text cannot be printed, is printed in italics, or if parts of objects around text fail to print at all, create an outline for the fonts being used.

If printing using a printer driver, select the [Download Font] checkbox.

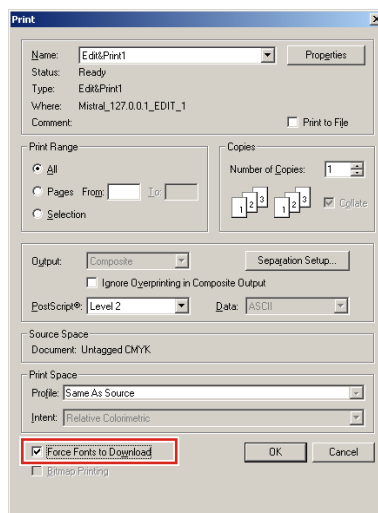
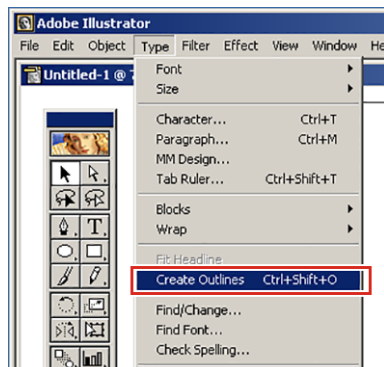

Circles and text appear as polygons

Circles and text will appear as polygons if the path output resolution is low in Adobe Illustrator or if the scale set in RasterLink7 is too high. (For example, when the scale for RasterLink7 is set to 1,000%.) The default path output resolution in Adobe Illustrator is 800 dpi. Either increase the path output resolution in Adobe Illustrator or reduce the scale in RasterLink7.

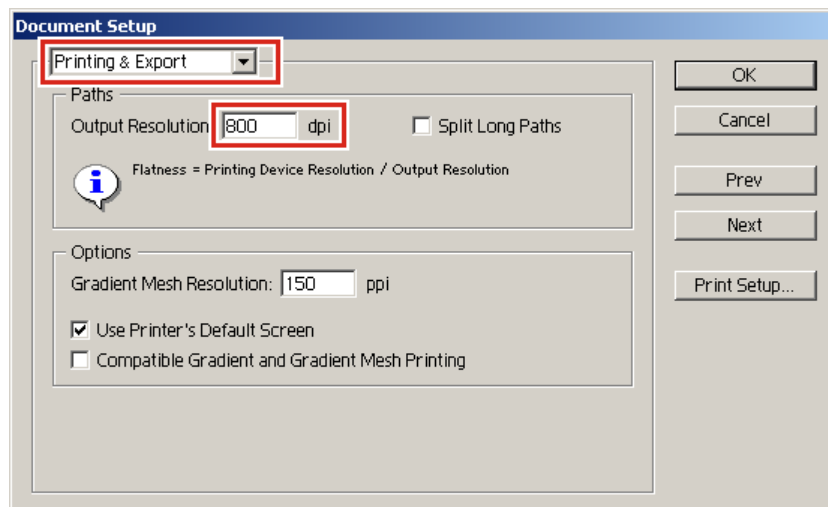

When increasing the path output resolution in Adobe Illustrator, calculate resolution using the following equation. No benefits will be gained even when a value greater than this is set.

There is no path output resolution setting when saving to an eps file. Output from Adobe Illustrator using the printer driver with [Smoothness] in [Graphics] set to [High quality].

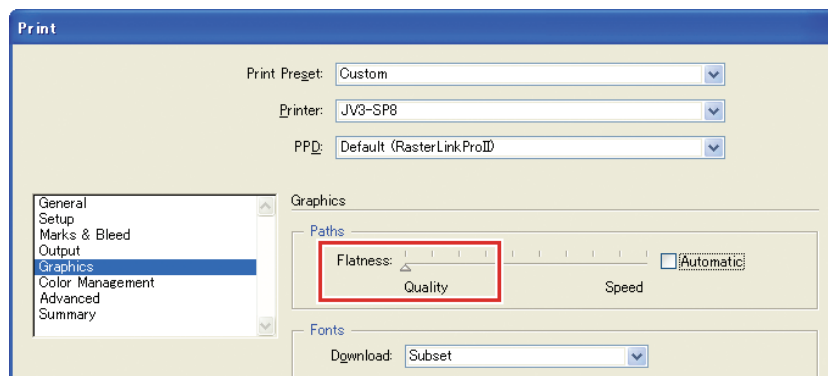

Circles and text may be printed as polygons if the scale value has not been increased in RasterLink7 or if the path output resolution has been increased in Adobe Illustrator.

If this occurs, select the corresponding objects in Adobe Illustrator, then use [Add Anchor Point] one to three times to shorten individual curve segments.

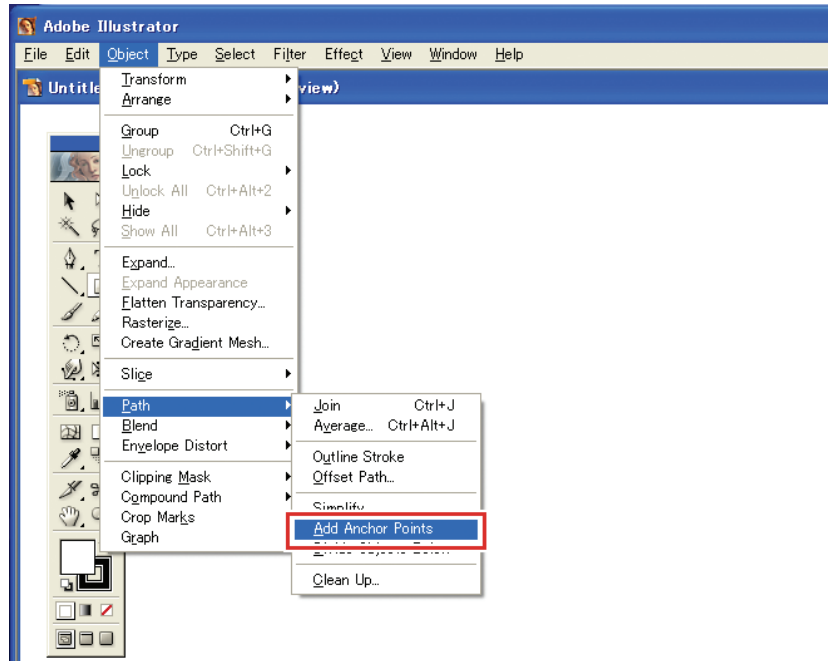

Text with transparency effects applied appears jagged

Text with transparency effects applied may appear jagged when enlarged in RasterLink7.

If problems like this occur, set [Document Setup] in Adobe Illustrator as follows.

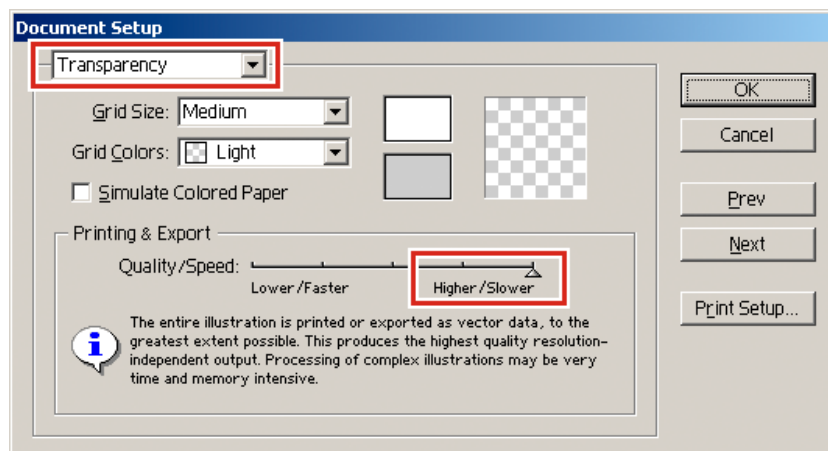

Some parts are not printed or unwanted lines are printed

Some rectangular parts may fail to print, or unwanted lines may print with complex objects or photographs with transparency effects applied.

If problems like this occur, set [Document Setup] in Adobe Illustrator as follows.

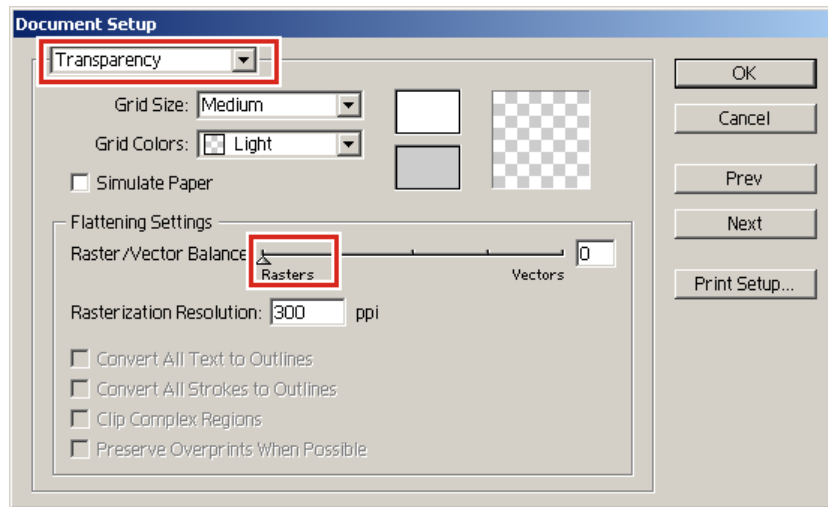

Problems occur with gradation printing

● Saving in eps format

Set the [EPS Options] as follows when saving in eps format.

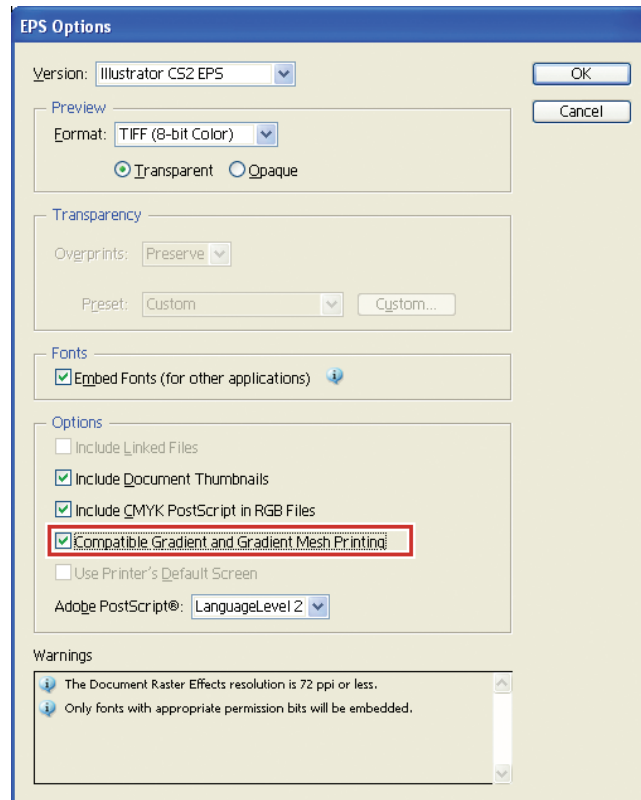

● Printing

Set the [Print] options as follows when outputting with the printer driver.

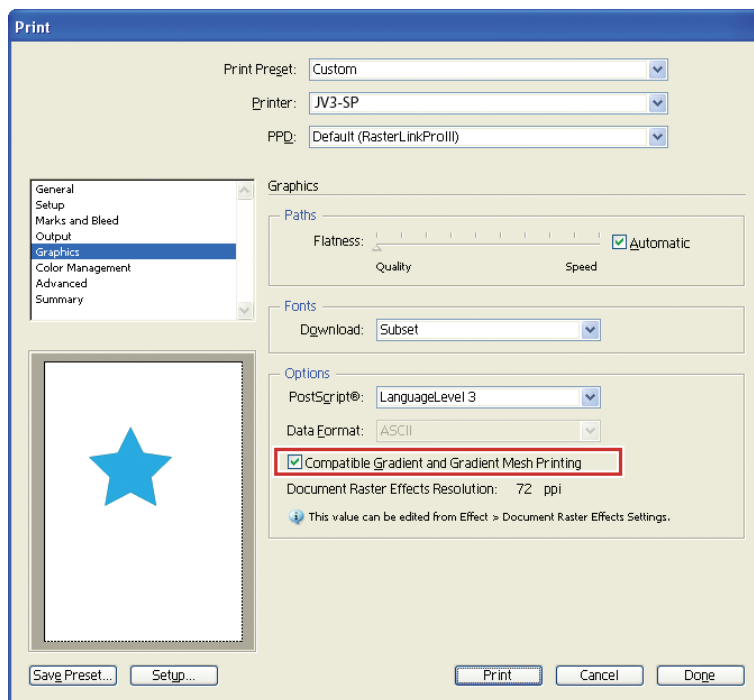

Important!

- In the case of data that includes gradation replacement, do not select the [Compatible gradation and Gradation mesh print] checkbox. This will prevent color replacement.

Positioned images are missing and ripping does not start

If data created in Adobe Illustrator contains positioned link images, embed these images using Adobe Illustrator.

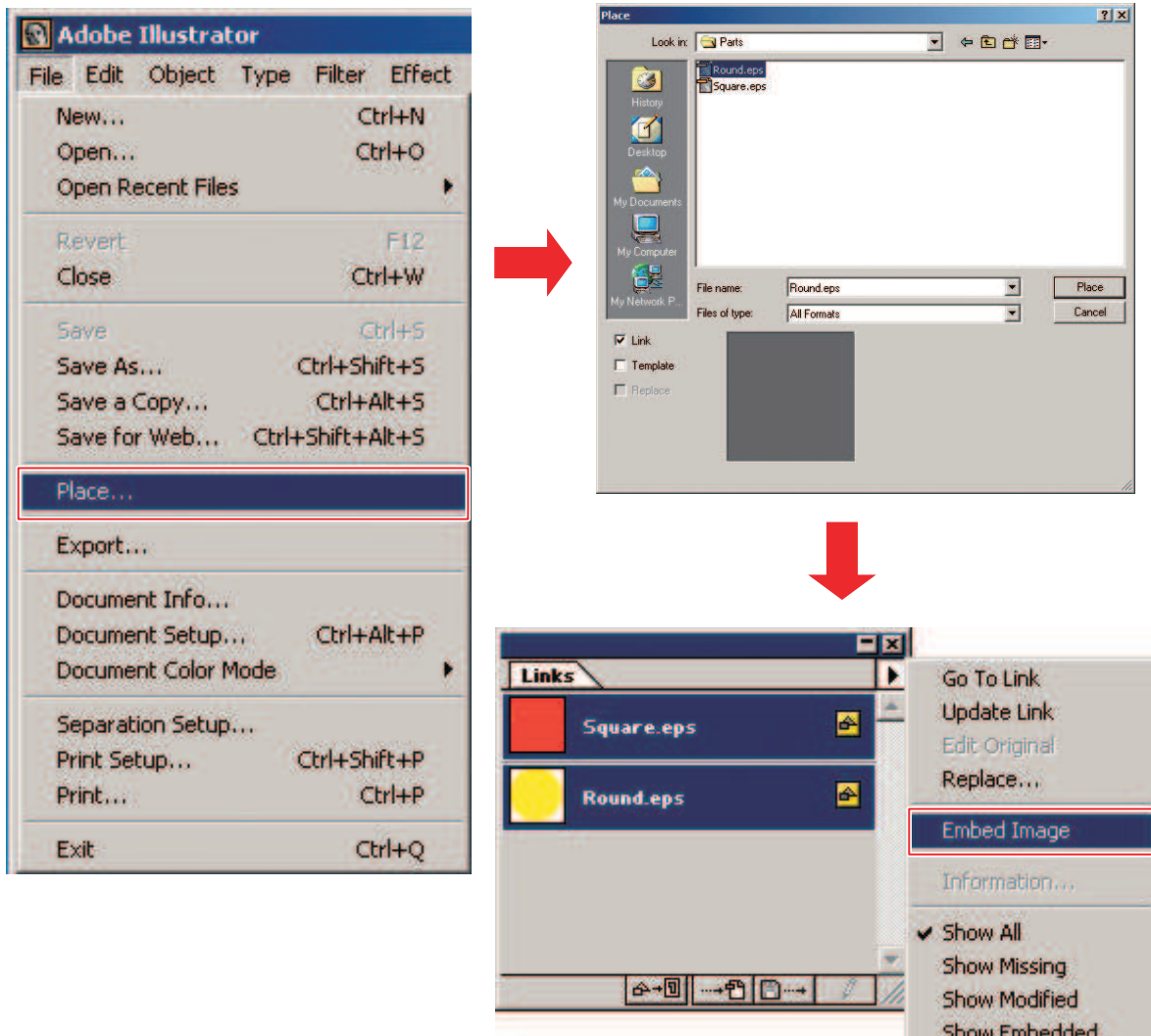

Parts surrounding images are missing

When rectangular objects are positioned with thin lines around images, the lines may become thinner or fail to print at all.

This occurs because Adobe Illustrator clips by rounding the overall image size to the nearest integer number of points when saving in eps format.

When using Adobe Illustrator, either place dummy objects around the image when saving in eps format or set a slightly larger PostScript custom page size with the printer driver output.

The image size in the design software differs from the image size in RasterLink7

The size of images created in design software will not perfectly match the image size displayed in RasterLink7. This can be due to a number of reasons.

- **Restrictions on how image size is handled in PostScript language**

Size is normally specified in units of mm or inches in design software, but in PostScript, values are managed in Points (1/72 inch).

The sizes of image objects are handled as the actual number of Points, but the overall size when saving as an eps file or PostScript custom page size for printer driver output is ultimately converted to an integer-based number of Points. This can result in conversion errors of up to 1 Point (0.353 mm).

- **Effects of line width**

The object size displayed in the [Information] window in Adobe Illustrator does not include line width. The actual object size will be the size including line width.

- **Effects of size calculation method in specific design software**

Effects occur due to specific size calculation methods in the design software, in the same way as described in  "Parts surrounding images are missing"(P. 314).

Because errors of approximately 1 Point will occur for this reason even when outputting at actual size, enlarging or reducing using RasterLink7 will increase these errors. (An error of 1 Point will become an error of 3.5 mm if enlarged by 1000%.)

If accuracy of the output size is an important factor, the following points should be borne in mind to minimize any errors:

- Try to print at actual size where possible.
- Set in % when enlarging or reducing. (Do not set values in mm or inches.)

The same location is cut twice or cut paths are not recognized.

When data with transparency effects applied is printed and cut using RasterLink7, cut data may be subject to cutting twice or cut paths may not be recognized.

If this occurs, set the data as follows in Adobe Illustrator:

- 1 Split print data and cut data onto separate layers and move the cut data layer to the top.

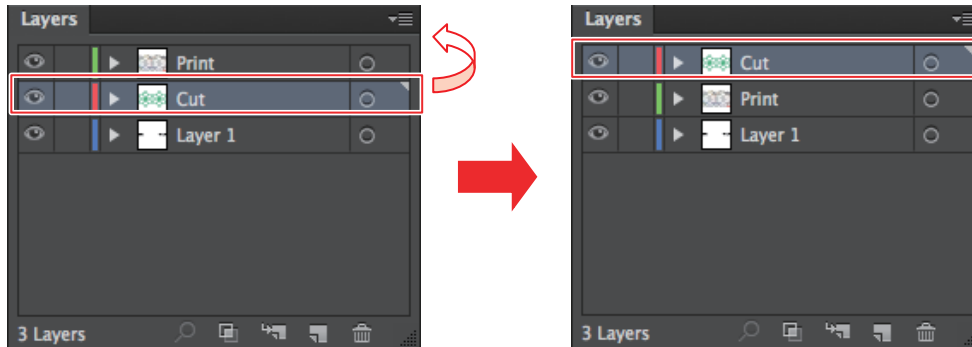

- 2 Click [File] - [Document Setup] - [Simulate Colored Paper] - [Custom], then unselect the [Convert all text to outlines] and [Convert all lines to outlines] checkboxes.

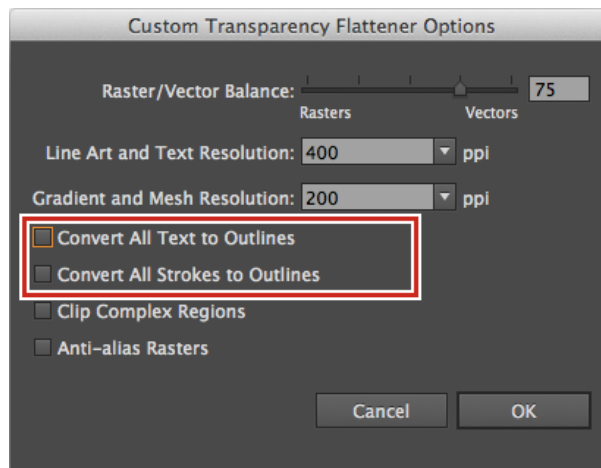

- This setting can also be configured using [Object] - [Flatten Transparency].



- If the above procedure does not resolve the issue, use the Adobe Illustrator file save function to save the data in PDF1.4 or later format.

Pattern objects are printed offset

When printing pattern objects created using Illustrator, the pattern objects may sometimes be printed offset compared to the Illustrator screen display.

The extent of the offset varies depending on the printing resolution.

It will also vary depending on the distance correction value for a flatbed printer, if specified.

- Illustrator screen display



- Printed results when scan direction distance correction is specified in RasterLink7



Select [Print Condition] - [Print Quality] - [RIP Core Setting], then enable the setting for [Renders pattern object with TilingType: 2 (no distortion)].

Alternatively, use the following procedure to set division and expansion for the object pattern:

1 Select the pattern object in Illustrator.

2 Select [Object] - [Expand].

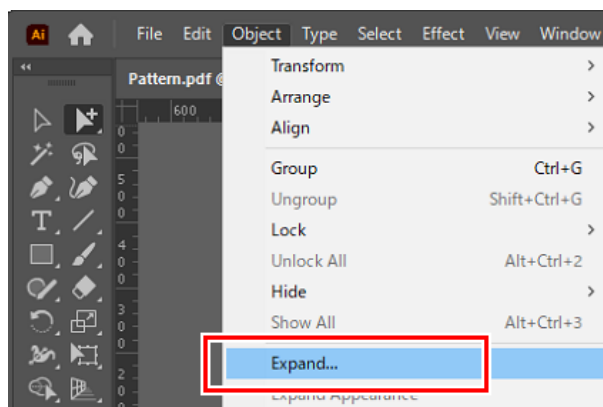

- The [Expand] dialog appears.

3 Click [OK].

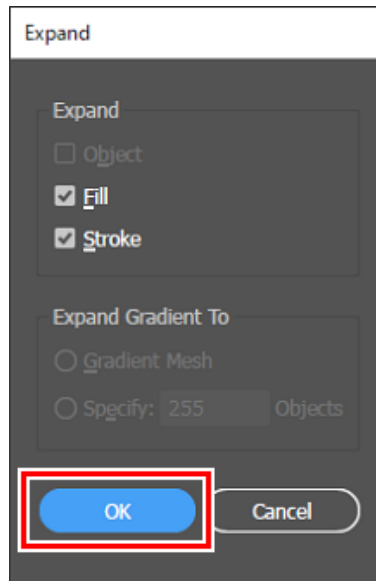

White objects are sometimes not printed

For white objects, if the [Overprint Fill] check box is selected on the [Attribute] panel, white objects may not be printed.



Color: CMYK (0,0,0,0)
Attribute: [Overprint Fill] selected

White objects are sometimes not printed under such conditions.

If this occurs, select the [Discard White Overprint in Output] check box in [Document Setup] in the [File] menu.

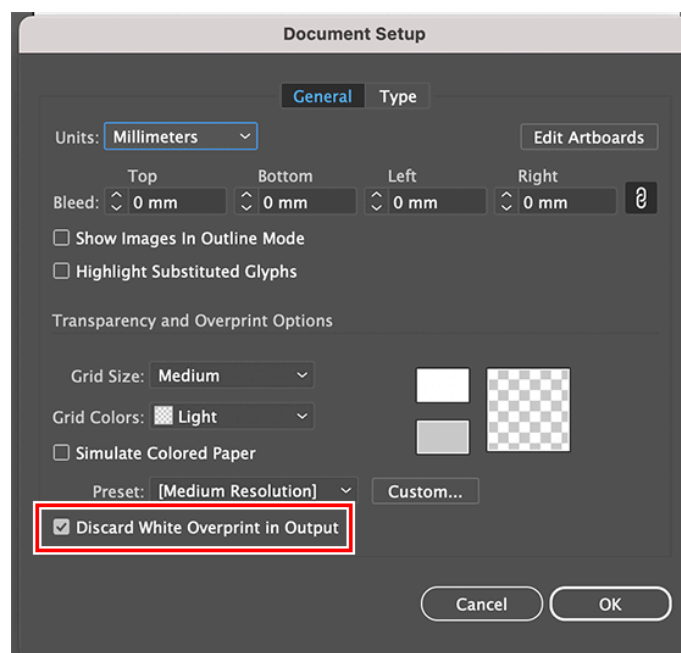

When importing image data, colors are sometimes automatically replaced with special colors, resulting in printing with unintended overlay printing conditions

When using PSD/TIFF data with spot color channels as an embedded image, special color names may be misrecognized when the image data is imported, resulting in special color replacement being automatically set.

If this occurs, avoid setting spot color channels for the image, as this results in printing with unintended overlay printing conditions.

Alternatively, disable color collection for the special color names used for the spot color channels.

5.4 Macintosh Related Issues

5.4.1 Precautions when using hot folders

Errors during file copying

Files for which copying was aborted will normally be ignored or produce a read error, but RasterLink7 may sometimes malfunction if incomplete files are imported. Avoid aborting file copying where possible.

5.4.2 Ways to improve import speed when printing from design software

With some design software, the output destination for printing can be changed to a hot folder, which improves the import speed. Try the following methods:

Data can be imported from the design software to a hot folder using the following procedure: It may not be possible to import some files. If this problem occurs, set the printer registered in RasterLink7 in [Printer] on the [Print] screen.

- 1 Open the [File] - [Print] menu in the design software.
- 2 Set a printer for RasterLink7 in [Printer].
 - Select [Adobe PostScript® File] in [Printer].
 - Select [MimakiInkjetPrinter (for macOS)] in [PPD].

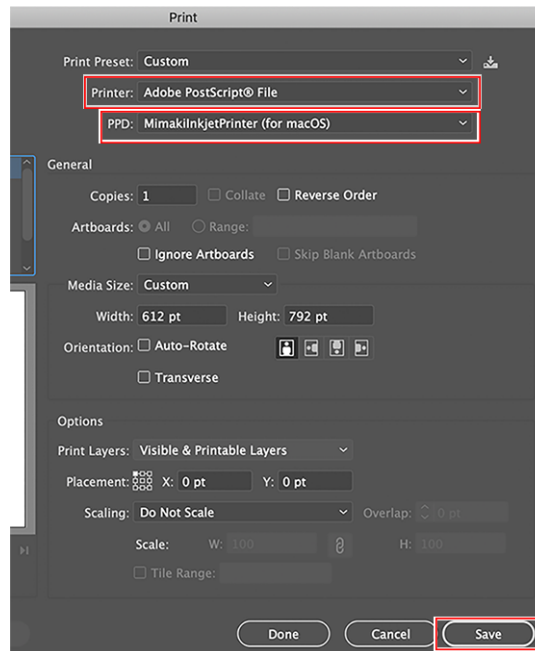

- 3 Click [Save].
- 4 Set the output destination to the RasterLink7 hot folder.
- 5 Click [Save].

5.5 Miscellaneous

5.5.1 Ways to improve ripping speed for images containing gradation objects

Ripping will take some time for images that contain complex gradation mesh objects or a large number of gradation objects. In such cases, the Adobe Illustrator settings can be altered to improve the ripping speed. Normally, the [Compatible gradation and Gradation mesh print] checkbox should be unselected. Try the following methods if this does not improve ripping speed:

Images containing a large number of gradation meshes or large gradation objects

Select the [Compatible gradation and Gradation mesh print] check box in the Adobe Illustrator settings.

Images containing a large number of gradations for filling and lines or large gradation objects

Unselect the [Compatible gradation and Gradation and Gradation mesh print] checkbox in the Adobe Illustrator settings.



- The [Compatible gradation and Gradation mesh print] setting applies either to gradation objects or gradation mesh objects only. Change the setting that specifies which of these should be applied in the Adobe Illustrator [Document Information] window.

Large number of gradation objects

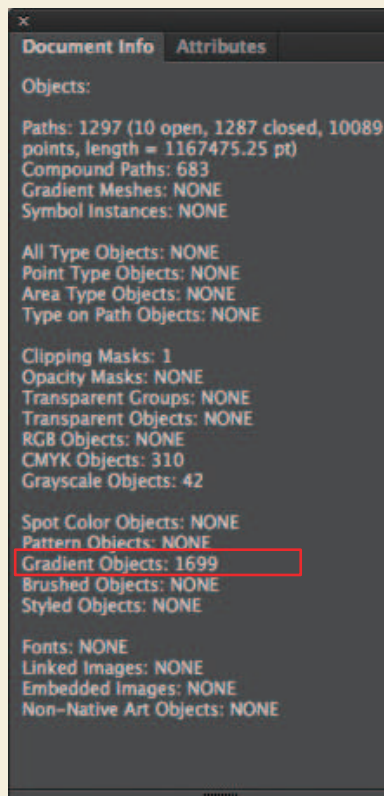

Large number of gradation mesh objects

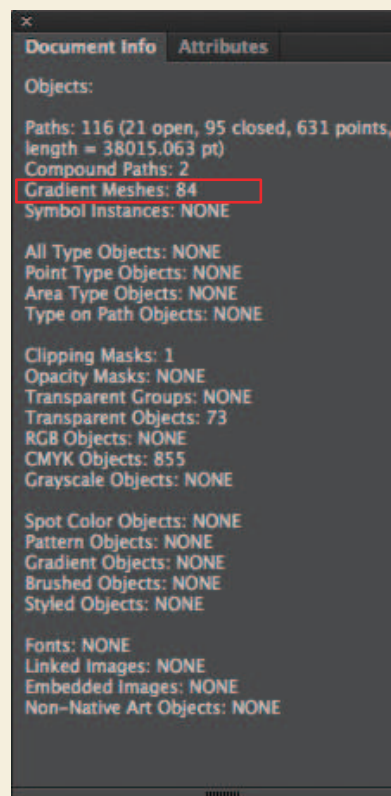

5.5.2 How to improve streaking when printing with a printer equipped with clear or primer ink

When printing with a printer equipped with a single clear or primer ink, the clear or primer ink may appear as streaks.

If this occurs, increase the number of passes by one level on the RasterLink7 [Print Condition] screen. This may resolve the issue.

5.5.3 Composite is possible but cannot be printed

In the following cases, compositing is possible but printing is not possible. If you want to print the image, recomposite the image with "Quality" before printing.

- UJF-6042MkII e CMYKCIPWW: Color to Clear

Chapter 6 Appendix



This chapter

Identifies the printer models and icons that can be used under certain printing conditions.

Available Printing Conditions, by Model	324	Special Conditions.....	334
Available Conditions by Cutting Device.....	327	About Type of Device Profile	335
Quick Reference Table of Conditions Preventing Function Icon Selection	328	Generic Profile	335
		Version of Device Profile.....	335
		About Media Name Types of v3 Profile	336

6.1 Available Printing Conditions, by Model

The following compatibility table lists models that support various [Print Condition] settings.

Supported settings are indicated by check marks in the row for that model.

● Using the compatibility table

Setting item numbers in the table correspond to the following setting items.

1. Pause Time per Scan
2. Drying time after printing
3. Cut after Print
4. Leading Margin / Trailing Margin / Follow by data
5. Heater OFF
6. Vacuum
7. Top Blower
8. Print Pinch Roller Pressure
9. Estimated print time
10. Color Pattern Print
11. Selecting a head unit for printing (multi-unit machines)
12. Printing white at higher density
13. Printing white at recommended density
14. Printing primer at recommended density
15. Printing clear at recommended density
16. Feed direction distance correction
17. Scan direction distance correction
18. Scan direction distance correction (auto correction)
19. Edge optimization
20. Media thickness
21. Ink saving
22. LamiFit

● Compatibility table

Model / Setting item	1	2	3	4	5	6	7	8	9	10	11	12	13	14	15	16	17	18	19	20	21	22
JV100	✓		✓	✓	✓	✓	✓		✓	✓	✓								✓			
UJV100			✓	✓		✓			✓	✓	✓		✓									
TS100	✓		✓	✓		✓	✓		✓	✓	✓											
UCJV300			✓	✓		✓		✓	✓	✓			✓									

Model / Setting item	1	2	3	4	5	6	7	8	9	10	11	12	13	14	15	16	17	18	19	20	21	22
JV300Plus	✓		✓	✓	✓	✓	✓		✓	✓	✓											
JV300	✓		✓	✓	✓	✓	✓		✓	✓	✓											
JV150	✓		✓	✓	✓	✓			✓	✓												
JV200	✓		✓	✓	✓	✓			✓	✓									✓		✓	
CJV300Plus	✓	✓	✓	✓	✓	✓	✓	✓	✓	✓	✓											
CJV300	✓	✓	✓	✓	✓	✓	✓	✓	✓	✓	✓											
CJV150	✓	✓	✓	✓	✓	✓		✓	✓	✓												
CJV200	✓	✓	✓	✓	✓	✓		✓	✓										✓		✓	
UJF-3042MkII													✓	✓		✓						
UJF-3042MkII EX													✓	✓		✓						
UJF-6042MkII													✓	✓		✓						
UJF-A3MkII, UJF-A3MkII EX													✓	✓		✓						
UJF-7151plus												✓		✓		✓						
UJF-3042MkII e												✓	✓	✓		✓			✓	✓		
UJF-3042MkII EX e												✓	✓	✓		✓			✓	✓		
UJF-6042MkII e												✓	✓	✓		✓			✓	✓		
UJF-7151plusII												✓	✓	✓		✓			✓	✓		
UJF-7151plusII e												✓	✓	✓		✓			✓	✓	✓	
JFX200-2513														✓		✓	✓					
JFX200-1213EX									✓				✓	✓	✓	✓	✓	✓				
JFX500														✓		✓	✓					
JFX200EX									✓				✓		✓	✓	✓	✓				
JFX600									✓				✓	✓		✓	✓	✓				✓
JV330	✓		✓	✓	✓	✓	✓		✓	✓	✓								✓		✓	
CJV330	✓	✓	✓	✓	✓	✓	✓	✓	✓	✓	✓								✓		✓	
Tiger600-1800TS									✓													
TS200			✓	✓		✓			✓	✓												✓
TS330	✓		✓	✓	✓	✓	✓		✓	✓	✓											

Model / Setting item	1	2	3	4	5	6	7	8	9	10	11	12	13	14	15	16	17	18	19	20	21	22
TS330-DS	✓			✓	✓	✓			✓	✓	✓											✓
SWJ-320EA	✓	✓		✓		✓				✓												
SIJ-320UV	✓	✓		✓		✓				✓												
UJV55				✓						✓		✓										
TS55	✓	✓		✓	✓	✓				✓												
TxF150	✓		✓	✓	✓	✓			✓	✓			✓							✓		
TxF300	✓		✓	✓	✓	✓			✓	✓			✓							✓		
Tx330	✓	✓		✓	✓	✓	✓		✓	✓	✓											✓
Tx330-Hybrid	✓	✓		✓	✓	✓	✓		✓	✓												✓
UCJV330			✓	✓		✓		✓	✓	✓	✓		✓							✓	✓	✓
UJV100Plus			✓	✓		✓			✓	✓	✓		✓							✓	✓	
UJV200			✓	✓	✓	✓			✓				✓							✓	✓	✓
UJV300DTF-75				✓		✓			✓				✓									
UJ330H				✓		✓			✓	✓	✓		✓							✓	✓	✓

6.2 Available Conditions by Cutting Device

This table shows the items available for individual cutting devices.

Supported items are indicated by check marks in the corresponding cutting device column.

Conditions	Detailed conditions	CG-AR Series	CG-FX II Plus Series
Cutting conditions	Auto Cut		✓
	Sort	✓	✓
	Sheet Feed	✓	✓
	Approximation Type	✓	✓
	Head withdrawal after cutting	✓	✓
	Split Cut	✓	
	Double pass creasing	✓	
Output	Intermediate register mark support	✓	
	Continuous output		
Compatible register mark types	Type 1	✓	✓
	Type 2	✓	✓
	Square register mark		
	Zero margin register mark		

6.3 Quick Reference Table of Conditions Preventing Function Icon Selection

This quick reference table identifies conditions under which function icons cannot be selected.

If a setting/condition with a check mark is enabled, the corresponding function icon cannot be selected.













For more information on icons, see  ["Function Icon List"\(P. 30\)](#).

● Using Table 1

The following functions are represented by icons from left to right at the top of the table.

1. PrintGroup
2. Arrange
3. Print Condition
4. Crop
5. General Print
6. Jig Print
7. Tiling
8. Step & Repeat
9. Variable Print
10. Execute
11. Special plate
12. Rigid Media Placement Printing

● Table 1

Setting / Condition	1	2	3	4	5	6	7	8	9	10	11	12
												
Register mark settings						✓	✓	✓				
Print area definitions						✓						
Separation marks		✓		✓		✓	✓	✓			✓	✓
Information labels						✓						
Lock the trimming position		✓				✓	✓	✓				
Cut lines						✓		✓				
2 or more copies							✓	✓				
Mirror									✓			

Setting / Condition	1	2	3	4	5	6	7	8	9	10	11	12
Formats other than PDF/ EPS/PS									✓			
Crop									✓			
Composite + 2 or more copies									✓			
Deskew									✓			
XY slitter	✓	✓				✓	✓	✓				✓
Execution status	✓	✓	✓	✓	✓	✓	✓	✓	✓	✓	✓	✓
With composite jobs							✓	✓			✓	
Arranged jobs	✓						✓	✓			✓	
Jig print jobs					✓		✓	✓			✓	✓
Tiling jobs		✓		✓	✓	✓		✓			✓	✓
Step & Repeat jobs	✓	✓			✓	✓	✓		✓		✓	✓
With Print & Cut jobs				✓		✓	✓	✓				✓
Kebab jig print jobs	✓				✓	✓	✓	✓				✓
RL output + jobs with register marks		✓		✓		✓	✓	✓	✓			
Multi-page jobs							✓	✓	✓			
Cut jobs							✓		✓		✓	
Braille jobs (compliant)		✓	✓	✓		✓	✓	✓	✓		✓	
Braille jobs (high speed/ normal)		✓	✓	✓			✓	✓	✓		✓	
Mono color (special color) jobs									✓			
Glossy print jobs*1												
Variable print jobs				✓			✓	✓				
Composite + variable print jobs												
Composite + color replacement jobs									✓			

Setting / Condition	1	2	3	4	5	6	7	8	9	10	11	12
2.5D print jobs				✓			✓	✓	✓		✓	
Composite + 2.5D print jobs				✓			✓	✓	✓			
Marginless Multi Mode							✓	✓				
Composite + Auto deskew jobs						✓	✓	✓	✓		✓	
Fotoba cut mark						✓						✓
OptiScout jobs	✓	✓		✓		✓	✓	✓	✓			✓
Media size crop jobs				✓					✓			

*1. Varies depending on model

● About arranged job and print group job settings

The following list shows the settings available for each job.

• Image Edit screen settings

Setting	Arranged jobs	PrintGroup jobs
[Scale]	✓	✓
Rotate	✓	✓
Deskew	✓	Printing allowed, editing not allowed
Mirror	✓	✓
Position	✓	✓
Arrange in the Center	✓	✓
Copy	✓	✓
Print Area	✓	
Layout	✓	✓
Register marks	✓	
Cut lines	✓	
Fotoba cut mark	✓	✓
XY slitter	✓	

Setting	Arranged jobs	PrintGroup jobs
Information labels	✓	Printing allowed, editing not allowed
Print order change		✓
Copy all		✓
Copying reverse even-numbered columns		✓

- **Rearrange settings**

Setting	Arranged jobs	PrintGroup jobs
Sequential	✓	✓
Sequential (Keep rotation)	✓	✓
Minimize	✓	✓
No rotation	✓	✓
Minimize (Keep rotation)	✓	✓
Jig		✓*1

*1. When using a flatbed printer

- **Function settings after setting Arranged/PrintGroup**











Setting	Arranged jobs	PrintGroup jobs
General Print setting	✓	
PrintGroup	-	-
Arrange	-	-
Jig Print	✓	
Trimming	✓	Printing allowed, editing not allowed
Print Condition	✓	✓
Composite		
Step & Repeat		
Kebab	✓	

● Using Table 2

The following functions are represented by icons from left to right at the top of the table.

1. Composite
2. Layer
3. Color Replacement
4. Favorite
5. Properties
6. Duplicate
7. Backup
8. Delete
9. Printer FAQ
10. Kebab jig printing

● Table 2

Setting / Condition	1 	2 	3 	4 	5 	6 	7 	8 	9 	10 
Register mark settings										✓
Print area definitions										✓
Separation marks	✓	✓								✓
Information labels										✓
Lock the trimming position										✓
Cut lines										✓
2 or more copies										
Mirror										
Formats other than PDF/EPS/ PS										
Crop										
Composite + 2 or more copies										
Deskew										
XY slitter										
Execution status	✓	✓	✓	✓	✓	✓	✓	✓	✓	✓
With composite jobs										

Setting / Condition	1 	2 	3 	4 	5 	6 	7 	8 	9 	10 
Arranged jobs	✓									
Jig print jobs	✓	✓								✓
Tiling jobs	✓	✓								✓
Step & Repeat jobs										✓
With Print & Cut jobs										✓
Kebab jig print jobs										
RL output + jobs with register marks										✓
Multi-page jobs										
Cut jobs			✓							✓
Braille jobs (compliant)			✓							✓
Braille jobs (high speed/normal)			✓							✓
Mono color (special color) jobs			✓							
Glossy print jobs*1										✓
Variable print jobs	✓									
Composite + variable print jobs			✓							
Composite + color replacement jobs										
2.5D print jobs			✓							✓
Composite + 2.5D print jobs										✓
Marginless Multi Mode										
Composite + Auto deskew jobs										✓
Fotoba cut mark										✓
OptiScout jobs										✓
Media size crop jobs										

*1. Varies depending on model

6.4 Special Conditions

● Base clear, Base primer, High-speed primer

Printing color layers directly on some media may cause dot bleeding, resulting in blurred thin lines and small characters.

In such cases, printing a primer or clear layer underneath the color layer enables sharp, non-bleeding characters and thin lines.

Base primer/High-speed primer also has the effect of a primer, and High-speed primer enables output in a shorter time.



- High-speed primer is supported only on UJF-7151plusIIe.

● LD1, LD2, LD3 (LD = Long Distance Mode)

It can be used with media that has a distance from the print head to the print surface.



- The distance from the print head to the print surface includes the print head gap.

Distance from the print head to the printing surface

- For 4.0mm or less: LD1
- For 6.0mm or less: LD2
- For 10.0mm or less: LD3



- The amount of ink mist tends to occur more frequently compared to the normal mode. When the gap widens, ink droplets fail to reach the media and become misted.
- Please perform cleaning after printing and regularly clean the nozzle area.
- When using LD Mode, color tones may change or image quality may be reduced.

6.5 About Type of Device Profile

This section describes the device profiles used by RasterLink series.

Device profile is provided by the combination of printer, ink set, material such as media, and printing conditions such as resolution and pass numbers.

6.5.1 Generic Profile

The profiles for general purpose.

The profile name includes "Generic".

ex.) Generic PVC Gloss

6.5.2 Version of Device Profile

There are two versions of device profiles available for use with the RasterLink series.

● v2 Profile

Profile extension is [cot].

The v2 profile can be used by RasterLink5 or earlier RIP software.

v2 Profile Creation Software

- Mimaki Profile Master II

● v3 Profile

Profile extension is [icc].

It is generally compatible with RIP software starting from RasterLink6, but some profiles are also supported by RasterLink5 depending on the version.

v3.x Profile Creation Software

- v3 to v3.4
 - Mimaki Profile Master II
- v3.5
 - Mimaki Profile Master 3

6.5.3 About Media Name Types of v3 Profile

For v3 Profile, different types of device profiles are available depending on the concept differences and versions.

The types are divided by the symbol at the end of media name.

● v3.x Profile

Device profiles have versions, which are appended to the end of the media name as "v3.x".

Unless "v3.x" is appended at the end, all profiles are v3.3 or later.

RasterLink Version Compatibility for v3 Profiles

- RasterLink5
It is compatible with v3 and v3.1, but not with v3.2 or later.
- RasterLink 6 or later
Compatible with all v3 versions.

Recommended values for RasterLink's color matching function

Recommended values for RasterLink's [color matching] function will vary

• v3 - v3.4 Profile

This profile recommends "Default".

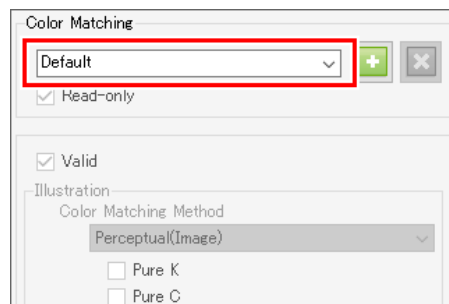

• Profile v3.5 or later

This profile recommends "Mimaki_Expand_Color" or "Deep_Color_Natural".

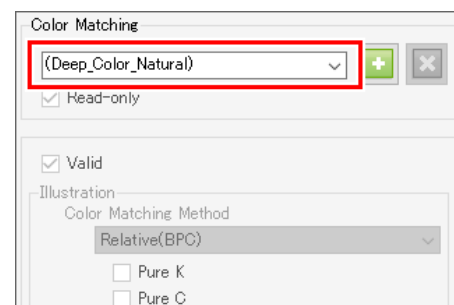
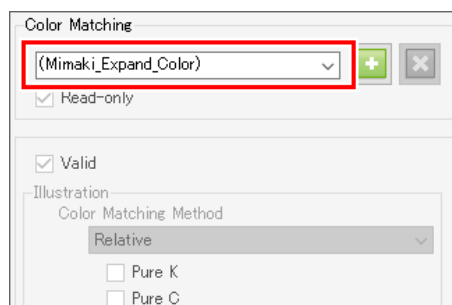

"D" to "LD"

File name suffix	Explanation
"_D"	The profiles are designed to raise the overall density based on the concept of emphasizing density. <ul style="list-style-type: none"> ex.) GPVC[441]_D v3
"-S" or "_s"	The profiles are designed to reduce the density based on the concept of ink consumption reduction. <ul style="list-style-type: none"> ex.) Mimaki GPVC[SPC706] -S
"Quality"	The profiles are designed to fill the dots in gaps to reduce graininess based on the concept of image quality improvement. <ul style="list-style-type: none"> ex.) Mimaki GPVC[SPC706] Quality
"sp"	The profiles are designed to fill the dots in gaps to reduce graininess based on the concept of image quality improvement. Use more Small dots and realize a smooth expression in photographic images. <ul style="list-style-type: none"> ex.) Mimaki GPVC[SPC706] v3.5sp
"br"	The profiles are designed based on the concept of banding reduction. Use more Large dots to reduce banding (Bi direction banding, streak banding etc.) The profiles are suitable for the data with many solid images. <ul style="list-style-type: none"> ex.) Mimaki GPVC[SPC706] v3.5br
"nr"	The Profiles are designed to reduce noise such as black spots. <ul style="list-style-type: none"> ex.) Generic Transfer Paper_nr
"White", "WonC", "ConW"	The Profiles for using white ink. Printing methods change according to the following notation.
	<ul style="list-style-type: none"> (White on Color), (WonC) The optimized profile for printing in order from Color to White. <ul style="list-style-type: none"> ex.) SABIC LEXAN8010Film(White on Color) ex.) Mimaki BckTLX[MSL140](WonC)
	<ul style="list-style-type: none"> (Color on White), (ConW) The optimized profile for printing in order from White to Color. <ul style="list-style-type: none"> ex.) SABIC LEXAN8010Film(Color on White) ex.) Mimaki BckTLX[MSL140](WonC)
	<ul style="list-style-type: none"> (withWhite) The optimized profile for using white ink environment irrespective of printing order. <ul style="list-style-type: none"> ex.) Mitsubishi AcryliteEX001(withWhite)
"LD"	(In front of media name) The optimized profile for the environment when using LD mode. <ul style="list-style-type: none"> ex.) LD1 UV-PET v3.5  About the explanation of LD mode, please refer to the instruction manual.

"G" to "ff"

File name suffix	Explanation
"G"	The profiles with gray balance adjustment. The profiles are optimized for "Gray Balance" mode in "Color Matching" of RasterLink. There are several versions for "G" profiles.
	<ul style="list-style-type: none"> v3G The profiles which are adjusted to optimize "Gray Balance" mode in "Color Matching" of RasterLink. – ex.) JC4k-Tropical v3G
	<ul style="list-style-type: none"> v3G-1 The profiles which are adjusted blueness lower than "v3G". – ex.) JC4k-Tropical v3G-1
	<ul style="list-style-type: none"> v3GDK The optimized profiles for using DeepBlack ink. – ex.) JC4k-Tropical v3GDK
	<ul style="list-style-type: none"> v3GBL The optimized profiles for using Bule ink and LightBule ink (Ver.2). – ex.) JC2K-Tropical v3GBL
	<ul style="list-style-type: none"> v3GBB The optimized profiles for using BrilliantBlue ink. – ex.) JC4k-Tropical v3GBB
	<ul style="list-style-type: none"> v3GBB-1 The profiles which are adjusted blueness lower than "v3GBB". – ex.) JC4k-Tropical v3GBB-1
	<ul style="list-style-type: none"> v3GKT The profiles for using transfer paper specific Black ink. – ex.) JC4k-Tropical v3GKT
"DK"	The optimized profiles for the environment of using DeepBlack ink. <ul style="list-style-type: none"> ex.) Coldenhove Jetcol HTR3000 DK
"ff"	This profile emphasizes the expression of fine lines. <ul style="list-style-type: none"> ex.) Generic Transfer paper_ff

That concludes the descriptions of each profile.

When there is any further information, please see the remarks section for each profile at downloading page.

RasterLink7 Reference Guide

April, 2026

MIMAKI ENGINEERING CO.,LTD.

2182-3 Shigeno-otsu, Tomi-shi, Nagano 389-0512 JAPAN

D203522-34-30042026

