

CUTTING PLOTTER

CG-60AR

CG-100AR

CG-130AR

Operation Manual

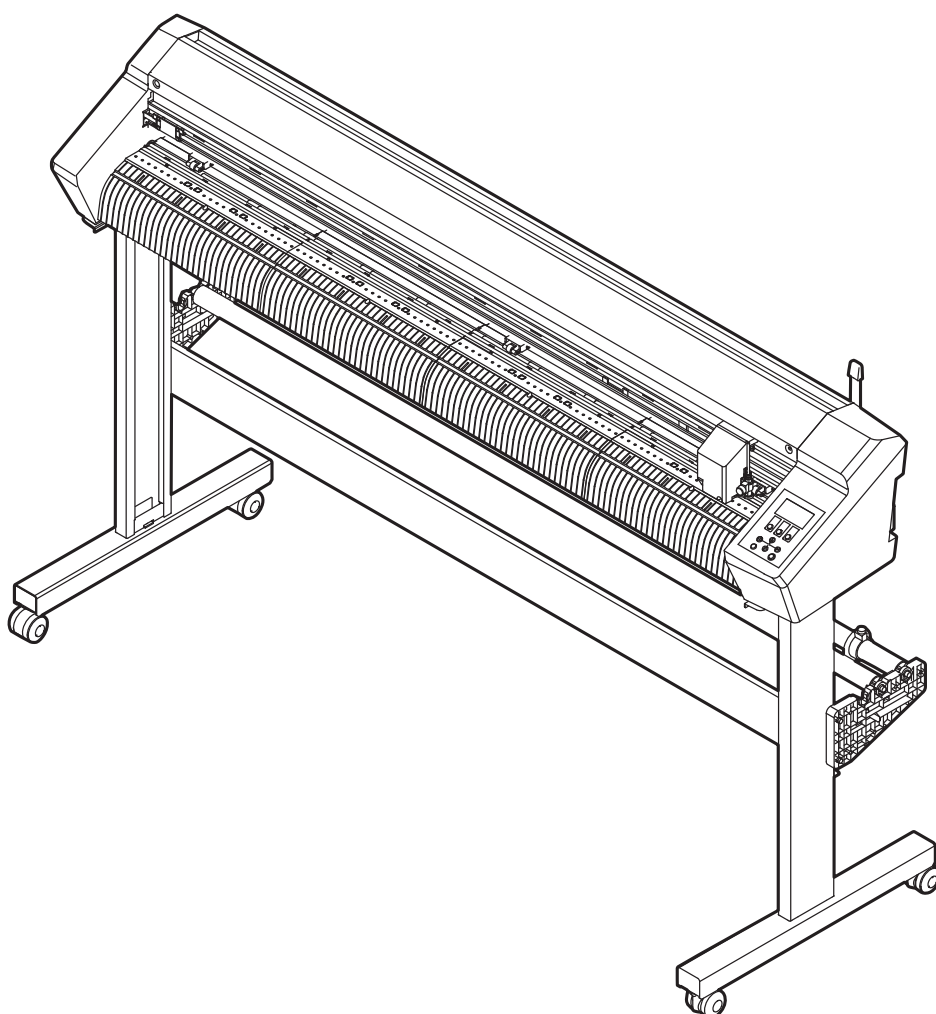

You can also download the latest manual from official website.

MIMAKI ENGINEERING CO., LTD.

<https://mimaki.com/>

D203577-12

Original instructions

Operation Manual

TABLE OF CONTENTS

Introduction	6
Product Description	8
To ensure safe use	9
Symbols	9
Usage Precautions	10
Installation Precautions.....	12
Installation Space	13
When moving This Machine	13
Warning Label.....	14

Chapter 1 Before Using This Machine

1.1 Preparation	16
Assembling the Legs and Sheet Basket	16
Attaching the cutter guard.....	16
Installing Cutting Software and Plotter Driver	20
Installing the Firmware Updater	21
1.2 Part Names and Functions	23
Front	23
Rear	25
Carriage	27
Pinch Rollers and Grit Rollers.....	28
SHEET sensor	28
Clamp	28
Tray.....	29
Operating panel	30
1.3 Connect host computer to machine.	33
Using a USB Cable	33
Using a LAN Cable	33
Using an RS-232C Cable	34
Notes on the setting items	35
1.4 Connecting the Power Cable	36
Turning On the Power.....	38
Turning Off the Power.....	38
1.5 System Configuration	40

Chapter 2 Cutting

2.1 Cutting Process	42
2.2 Loading a Sheet.....	44
Loading a Leaf Sheet (Cut Sheet)	47
Loading a Roll Sheet (CG-60AR)	48
Loading a Roll Sheet (CG-100/130AR)	52
Pinch Roller Position/Number and Clamp Settings	55
2.3 Installing Tools.....	59
Using the Cutter	59
Using a Pen	63
Using the Creasing Tool	67

2.4 Selecting Tool Conditions	68
2.5 Setting Tool Conditions.....	69
2.6 Test Cutting	72
2.7 Cut the data.	73
Setting the Origin	73
Starting Cutting	73
Pausing Cutting	74
Aborting Cutting (Data Clear)	74
Retracting the Carriage.....	74
2.8 Separating Sheets (Manual Cutting).....	75

Chapter 3 Cutting Data with Register Marks

3.1 Process for Cutting Data with Register Marks	78
3.2 Creating Register Marks	80
Register Marks.....	80
Register Mark Size	81
Spacing Between Register Marks.....	82
Reading Range of Register Marks.....	82
No-Plotting Areas Around Register Marks	84
Register Mark Detection Precautions	84
3.3 Setting Register Mark Detection Conditions	85
Notes on Register Mark Detection Setting Items.....	85
3.4 Detect register marks.....	89
Checking Sheet Tilt Using the LED Pointer	89
Detecting Register Marks Using Full-Automatic Detection	90
Detecting Register Marks Using Semi-Automatic Detection.....	92
Detecting Register Marks Automatically After Sheet Detection.....	95
3.5 ID Cut Process.....	97

Chapter 4 Helpful Tips

4.1 Jog Mode Functions	100
2-Point Line Correction [AXIS CORRECT]	100
Cut Area Setting [CUT AREA]	101
Digitizing [DIGITIZE]	101
4.2 Length Correction [DIST.COMP.]	103
4.3 Cutting Multiple Copies of the Same Data [MULTI COPY]...	106
4.4 Expanding the Cutting Area [EXPANDS].....	108
4.5 Selecting the Cutting Movement Direction [ROTATION]	109
Setting Rotation	109
4.6 Divided Cutting [DIVISIONcut].....	111
Y Direction (Width Direction) Divided Cutting	112
X Direction (Feed Direction) Divided Cutting	114
4.7 Changing the Cutting Sequence [SORTING]	116
Setting Sorting	117
Sorting Procedure	117

4.8 Operating the Main Unit Panel Remotely [R.CONTRL]	118
4.9 Other Useful Functions	120
Sheet Feed	120
Pause [HOLD].....	120
Feed Settings [FEED OPTION]	121
Preventing Uncut Media [OVER CUT/CORNER CUT].....	123
Configuring the Network Settings [NETWORK].....	124
Event Email Function Settings [EVENT MAIL]	125
Outputting the Settings List [LIST]	129
Copying Settings from Other User Settings [CONFIG COPY].....	130
Restoring Default Settings [SETUP RESET]	130
Changing Users [CHANGE USER].....	131
Outputting Received Data as ASCII Code [DUMP]	131
Selecting the Screen Display Language [DISPLAY].....	131
Checking Machine Information [INFORMATION]	132

Chapter 5 Settings

5.1 FUNCTION	134
SET UP.....	135

Chapter 6 Maintenance

6.1 Maintenance Precautions	142
6.2 Maintenance Items and Timing.....	143
Items Required for Maintenance.....	143
6.3 Maintenance Procedure.....	144
Cover (Exterior) Cleaning	144
Cleaning the Y-Bar Rail Surfaces	145
Cleaning the Grit Rollers.....	146
Cleaning the Pinch Rollers	146
When Not in Use for Extended Periods	146
6.4 Consumable Item Replacement	147
Cutter Replacement.....	147
Pinch Roller Replacement	147
Pen Line Rubber Replacement.....	148

Chapter 7 Options

7.1 Sheet Tables and Cutting Sheet.....	152
Attaching the Sheet Tables.....	152
Loading a Sheet on the Cutting Sheet.....	153
Cutting	154
Storing the Cutting Sheet.....	157

Chapter 8 Troubleshooting

8.1 Troubleshooting	160
Checking Register Mark Sensor Responsiveness.....	162
Aligning the Register Mark Sensor Position	164
Investigating the Cause of Cutting Failures	165
8.2 Problems Indicated by Messages.....	167
Error Messages	167
Display Message List.....	170

Chapter 9 Appendix

9.1 Specifications.....	174
9.2 Repetition Accuracy Conditions.....	176
9.3 Setting Sheet	177

Introduction

Thank you for purchasing the Cutting Plotter CG-60/100/130AR.

Read this operating manual ("this document" hereinafter) thoroughly and make sure you understand its contents to ensure safe and correct use of the product.

Please note that the illustrations contained in this manual are intended to show functions, procedures, or operations and may sometimes differ slightly from the actual machine.

Adobe, the Adobe logo, Acrobat, Illustrator, Photoshop, and PostScript are the trademarks or registered trademarks of Adobe Incorporated in the United States and other countries.

RasterLink is a trademark or a registered trademark of Mimaki Engineering Co. Ltd. in Japan and other countries.

Other company and product names mentioned herein are the trademarks or registered trademarks of the respective companies in Japan and in other countries.

Unauthorized reproduction of any portion of this document is strictly prohibited.

© 2021 MIMAKI ENGINEERING Co., Ltd.

● Disclaimers

- Mimaki Engineering accepts no liability for damages arising directly or indirectly from the use of the CG-AR ("this machine" hereinafter), whether or not the product is faulty.
- Mimaki Engineering rejects all liability for damages, direct or indirect, attributable to materials created while using this machine.
- Using this machine in conjunction with devices other than those recommended by Mimaki Engineering may result in fire or accidents. Such incidents are not covered by the product warranty. Mimaki Engineering rejects all liability for damages, direct or indirect, arising from such incidents.

● TV and radio interference



- The machine emits high-frequency electromagnetic radiation while operating. Under certain circumstances, this may result in TV or radio interference. We make no guarantee that this machine will not affect special radio or TV equipment.
-

If radio or TV interference occurs, check the radio or TV reception after turning off the machine. If the interference disappears when the power is turned off, the machine is likely to be the cause of the interference.

Try any of the following solutions or combinations of these solutions:

- Change the orientation of the TV or radio antenna to find a position where interference does not occur.
- Move the TV or radio away from this machine.
- Plug the TV or radio into a power outlet on a power circuit other than the power circuit to which this machine is connected.

● FCC (Federal Communications Commission) regulations

The machine has been tested and certified to comply with restrictions applying to Class A digital devices under Part 15 of the FCC regulations. These restrictions are designed to provide suitable protection from harmful interference when the printer is used in commercial environments.

This product may generate, use, or emit radio frequency energy and may cause harmful interference with radio communications if not installed or used in accordance with the operating manual.

Use of this product in residential areas may cause harmful interference. If so, the user is responsible for rectifying such interference.



- Use only the cables recommended by Mimaki Engineering when connecting to the machine. Use of other cables may cause the product to exceed the restrictions stipulated by FCC regulations. To maintain compliance with FCC regulations, use the cables recommended by Mimaki Engineering.
-

Product Description

This section describes the features of this machine. Please use this section in conjunction with the operating procedures described in this document to familiarize yourself with cutting procedures.

● Mark sensor function

High-accuracy register mark reading sensors are used to automatically read register marks printed on sheets. This allows distance correction, print origin setting, and sheet tilt correction.  ["Cutting Data with Register Marks"\(P. 77\)](#)

● Two-stage clamping pressure selection function

The sheet clamping mechanism provides a choice of two clamping pressures, expanding the range of sheets that can be used with this machine. High pressure greatly increases the clamping pressure, preventing sheet slippage during long-sheet cutting.

Low pressure minimizes any damage to the sheet caused by the grit rollers during cutting.  ["Setting the Clamp High/Low Mode"\(P. 57\)](#)

● ID cutting function

This allows data to be printed with an ID on a printer, enabling it to be detected and cut automatically using this machine.  ["ID Cut Process"\(P. 97\)](#)

● Plug-in cutting software provided as standard

The MIMAKI FineCut/Coat9 plug-in cutting software enables text and graphics edited in Illustrator to be cut easily and cleanly.  ["Installing Cutting Software and Plotter Driver"\(P. 20\)](#)

● Cutting using Windows plotter driver

Using the Windows plotter driver allows cutting data to be output from applications such as Microsoft Word and Excel in addition to the MIMAKI SimplePOP design software. For more information on the supported applications, refer to "Readme" on the installation screen for the Windows plotter driver.  ["Installing Cutting Software and Plotter Driver"\(P. 20\)](#)

● Heavy-weight media cutting and creasing

Heavy-weight media can be cut and creased using the sheet table and cutting sheet.  ["Sheet Tables and Cutting Sheet"\(P. 152\)](#)









● Roll stopper function (CG-100/130AR only)

The roll stopper prevents the sheet from rotating when the roll sheet is pulled out. A roll stopper mechanism is used to reduce roll sheet meandering. The improved sheet feeding surface also reduces roll sheet jamming. This eliminates unwanted problems.  ["Roll stopper"\(P. 53\)](#)

To ensure safe use

Symbols

In this manual, the symbols indicate and explain precautions. Make sure you fully understand the meaning of each symbol and use the machine safely and correctly.

Explanation		
	Warning	Indicates a potential hazard that may result in death or serious injury if handled improperly or if instructions are disregarded.
	Caution	Indicates a potential hazard that may result in minor or moderate injury if handled improperly or if instructions are disregarded.
	Notice	Indicates a potential hazard that may result in property damage if handled improperly or if instructions are disregarded.
	Warning sign	Indicates something that requires attention. Warning specifics are drawn inside the symbol.
	Mandatory action sign	Indicates an action that must be carried out. The specifics of the mandatory action are drawn inside the symbol.
	Prohibition sign	Indicates a prohibited action. The specifics of the prohibited action are drawn inside the symbol.
	Important	Indicates important information related to use of this machine.
	Tip	Indicates useful reference information.
	Reference information	Indicates the corresponding page for related information.

Usage Precautions

● In the event of abnormal conditions

WARNING



- In the event of abnormal conditions such as smoke or unusual odor, turn off the main power immediately and unplug the power cable. Continuing to use the machine under these conditions may result in failure, electric shock, or fire. Once you have confirmed that smoke is no longer being emitted, contact your local dealer or our service office. Never attempt to repair the machine yourself, which is hazardous.

● Power supply precautions

WARNING



- Use the power cable provided. Otherwise there is a risk of failure, electric shock, or fire. Do not use the power cable with other electronic devices.
- Always grasp the plug when unplugging the power cable. Pulling on the power cable itself may damage the cable and result in failure, electric shock, or fire.
- Do not use the power plug with dust on it. Otherwise there is a risk of failure, electric shock, or fire.
- Avoid touching the blade of the power plug with a metal object. Otherwise there is a risk of failure, electric shock, or fire.
- Do not attempt to modify the cable. Avoid damaging the cable. Avoid placing heavy objects on the power cable or pulling on or exposing the cable to heat. Doing so may damage the cable, resulting in electric shock or fire.
- Do not use extension cords or multi-outlet extension cords. Otherwise there is a risk of failure, electric shock, or fire.
- Do not use if the power cable appears to be damaged or the core wire has an exposed or broken core. Otherwise there is a risk of failure, electric shock, or fire.



- Do not handle the power plug with wet hands. Disregarding this precaution may result in electric shock.



- Plug the power cable plug into a grounded power outlet. Otherwise there is a risk of failure, electric shock, or fire.
- When installing electrical outlets, perform grounding work to prevent electric shock. All electrical work (Class C grounding work; formerly Type 3 grounding work) must be handled by a licensed electrician.

NOTICE



- Use the machine with a power supply that meets specifications.
- Be sure to plug the power cable into a power outlet close to the machine. Insert the power plug blade securely.
- When connecting the power cable, check the input voltage of the power outlet and the capacity of the breaker. Also, connect each cable to a separate power source with an independent breaker. Connecting to power outlets linked with the same breaker will cause the breaker to trip.

● Caution regarding moving parts

CAUTION



- Do not touch the rotating grit rollers. There is a risk of injury due to abrasion of the skin or fingernails of hands.
- Keep parts of the body such as the face and hands away from moving parts. Also keep clothing (e.g., loose clothing and accessories) that may impede work away from the machine. Failure to do so may result in injury.



- Long hair should be tied back. Failure to do so may result in injury.

● Do not disassemble or repair

WARNING



- Do not attempt to disassemble or repair this machine. Otherwise there is a risk of failure, electric shock, or fire.

● Handling the cutter

CAUTION



- Avoid touching the cutter blade. Failure to do so may result in injury.
- Do not shake or swing the cutter holder. Doing so may cause the blade to come off.

● Note about sheets

NOTICE



- Curled sheets must be uncurled before use. Cutting (and printing) may be affected by excessive curling.

● Other usage precautions

WARNING



- Keep children away from this machine.

NOTICE



- Printing may show through from the underside depending on the sheet type and sheet storage method after printing (such as the load due to placing flat sheets that have been rolled up). Perform a test beforehand to check that print does not show through from the underside.

● Disposing of the product

CAUTION



- Please contact your local retailer or service agent.
- When disposing of the product yourself, contact an industrial waste disposal operator or dispose of the product in accordance with local laws and regulations.

Installation Precautions

WARNING



- Do not install this machine in environments where flammable substances are present (e.g., gasoline, flammable spray, alcohol, thinner, lacquer, or powder). This machine is not explosion-proof. The product poses a risk of explosion.



- Do not place vases, pot plants, cups, cosmetics, containers of chemicals or water, or small metal objects on top of this machine. There is a risk of failure, electric shock, or fire if liquids or items drop inside the machine.



- Do not install this machine in humid locations or locations where it may be exposed to splashing water. Otherwise there is a risk of failure, electric shock, or fire.



- Avoid installing this machine in locations accessible to children.

NOTICE



- Do not install this machine in locations where dust or powder is present. Failure may result if dust gets inside this machine.
- Do not install this machine in locations exposed to drafts (e.g., from air conditioning). Disregarding this precaution may result in dust or powder getting inside this machine.
- Do not install this machine in unstable locations or locations subject to vibration. Disregarding this precaution may result in failure.
- Do not install this machine in locations exposed to direct sunlight.
- Do not install this machine in locations subject to sudden temperature changes. Disregarding this precaution may result in failure.
- Do not install this machine in locations exposed to excessive noise from large machinery.



- Operating environment: 5 °C to 35 °C (41 °F to 95 °F), 35 %RH to 75 %RH (no condensation)

Installation Space

Make sure sufficient installation space is available before assembling this machine. Consider the size of the machine and the space required for printing work before installing the machine.

Item	CG-60AR	CG-100AR	CG-130AR
Width	1,010 mm	1,510 mm	1,810 mm
Depth	355 mm (580 mm)*1	580 mm	580 mm
Height	355 mm (1,160 mm)*1	1,160 mm	1,160 mm
Weight	17 kg (27 kg)*1	35 kg	43 kg

*1. The CG-60AR is not equipped with legs as standard. The dimensions in parentheses apply when the optional legs are fitted.

The CG-100/130AR are equipped with legs as standard.

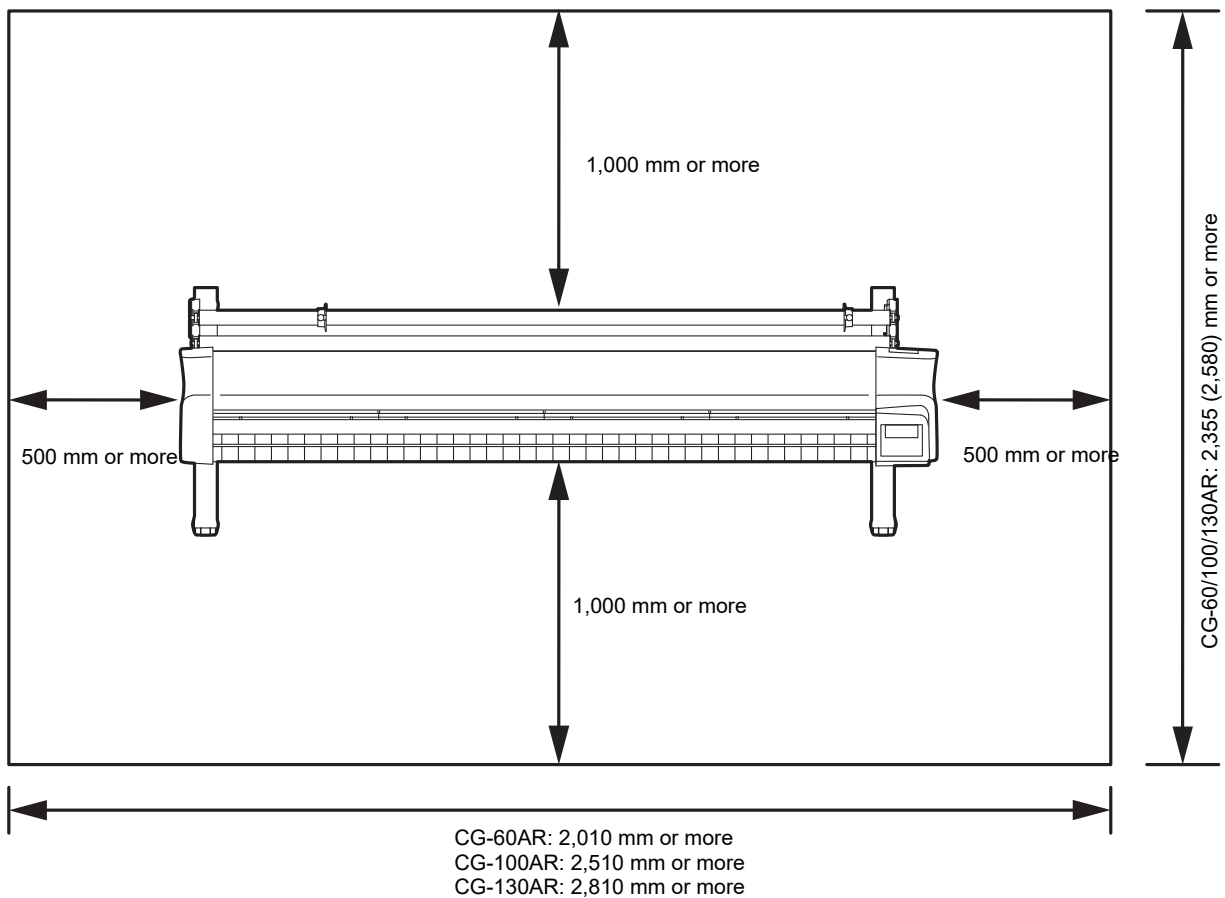

When moving This Machine

Move with legs on the step-free same floor only.





- Do not move by pushing the cover. Otherwise the cover may be damaged.

Warning Label

Make sure you fully understand the details indicated on the various warning labels.

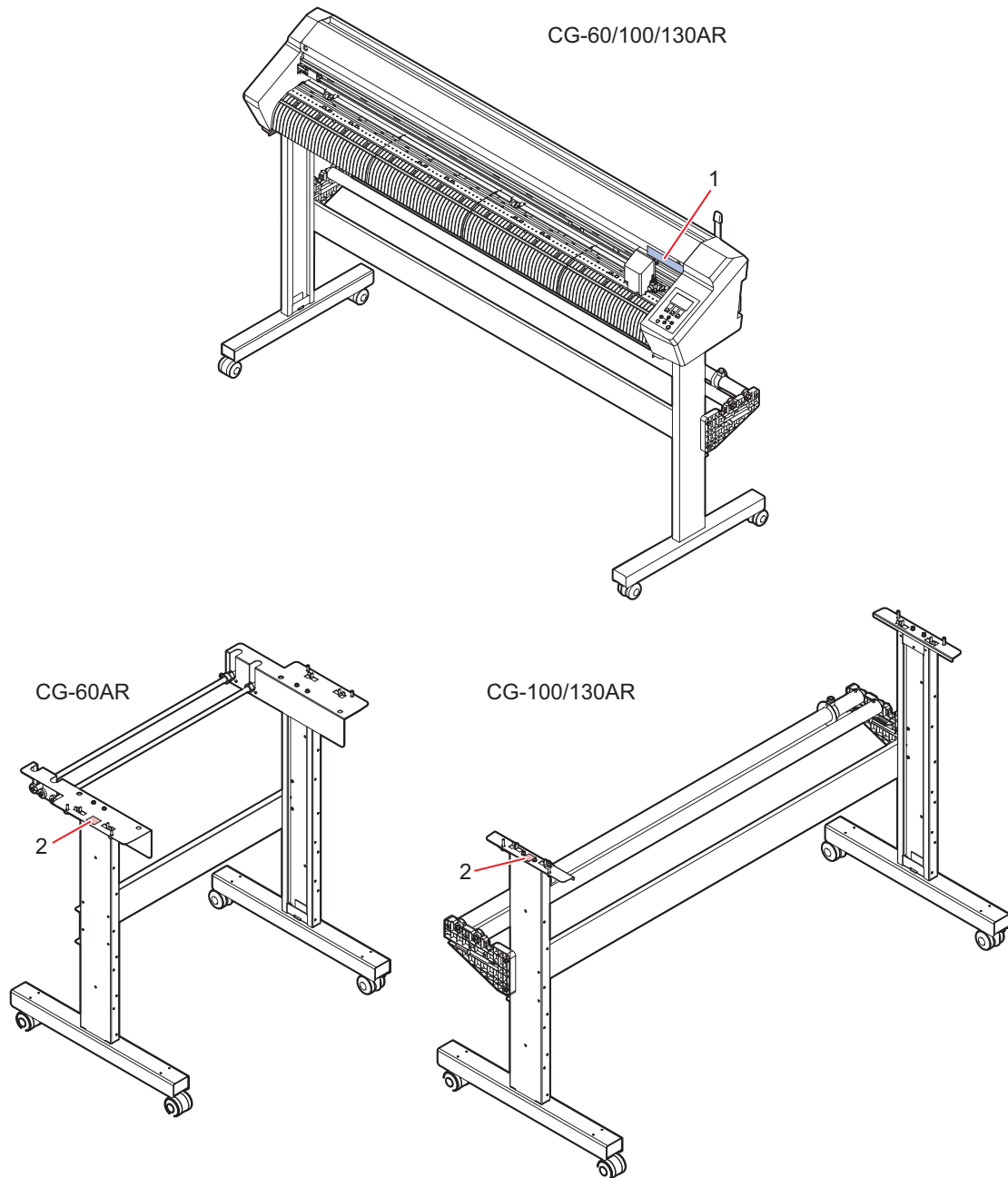
If any of the warning labels becomes dirty and illegible or peel off, contact your local dealer or our service office to request new warning labels.



No.	Order code	Label	Details
1	M904451		PL label <ul style="list-style-type: none"> • Be careful not to touch the cutter or grit rollers while this machine is operating. Failure to do so may result in injury.
2	M917473		Caution label <ul style="list-style-type: none"> • This machine must be assembled by at least two persons.

Chapter 1 Before Using This Machine



This chapter

Describes items such as the individual part names with which operators should familiarize themselves before using this machine.

Preparation.....	16	Connect host computer to machine.....	33
Assembling the Legs and Sheet Basket	16	Using a USB Cable	33
Attaching the cutter guard	16	Using a LAN Cable	33
Installing Cutting Software and Plotter Driver		Using an RS-232C Cable.....	34
.....	20	Notes on the setting items	35
Installing the Firmware Updater	21	Connecting the Power Cable.....	36
Part Names and Functions	23	Turning On the Power.....	38
Front.....	23	Turning Off the Power.....	38
Rear	25	System Configuration	40
Carriage	27		
Pinch Rollers and Grit Rollers.....	28		
SHEET sensor	28		
Clamp.....	28		
Tray.....	29		
Operating panel.....	30		

1.1 Preparation

Assembling the Legs and Sheet Basket

Assemble the legs (CG-60AR is optional) and attach the sheet basket (option).

When assembling the sheet basket, make use of the assembly instruction video as described below or read the "Assembly Procedure" included with this machine carefully.

When assembling the legs (CG-100/130AR), make use of the assembly instruction video as described below or read the "Assembly Procedure" included with this machine carefully.

The "Assembly Procedure" can be downloaded from the following URL:

<https://mimaki.com/product/cutting/c-roll/cg-ar-series/download-manual.html>

Important!

- The legs for the CG-60AR are options available separately. Contact your local dealer or our service office. No "Leg Stand Assembly" video is provided for the CG-60AR. Read through the "Assembly Procedure" included with this machine or downloaded from the following URL carefully before assembling: <https://mimaki.com/product/cutting/c-roll/cg-ar-series/download-manual.html>

1 Scan the following QR code with a smartphone or tablet: (Required first time only)

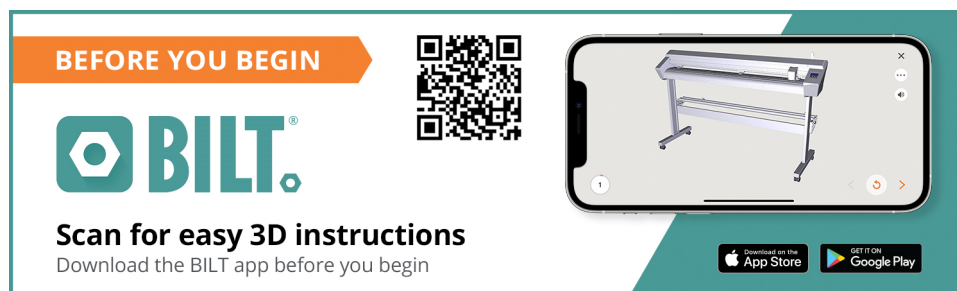

- BILT starts up automatically, if it is already installed.
- If BILT is not installed, a screen appears for installing it. Install and launch BILT.

2 Tap on the bar at the top left of the BILT home screen.

3 Select [Settings] > [Languages], then tap on the desired language.

4 Enter "CG-AR Roll_Based Cutting Plotter" in [Product search] on the home screen.

5 Select [CG-AR Roll_Based Cutting Plotter] > [Leg Stand Assembly] (CG-100/130AR) or [Sheet Basket Installation], then tap on [Start].

- The video will play.



- The video can subsequently be checked from the BILT [My stuff] page.

Attaching the cutter guard

The cutter guard is used to prevent the sheet from lifting up.

It is recommended that the cutter guard be attached if the sheet may be damaged by the cutter due to the sheet lifting during cutting.



- Turn off the machine power supply before attaching or removing the cutter guard.
- Attaching the cutter guard reduces the size of the gap below the carriage. Remove the cutter guard if it prevents loading of thick sheets.

● Attaching the cutter guard

1 Remove the carriage cover.

- (1) Remove the screw on the front of the carriage cover.
 - Do not to lose this screw.

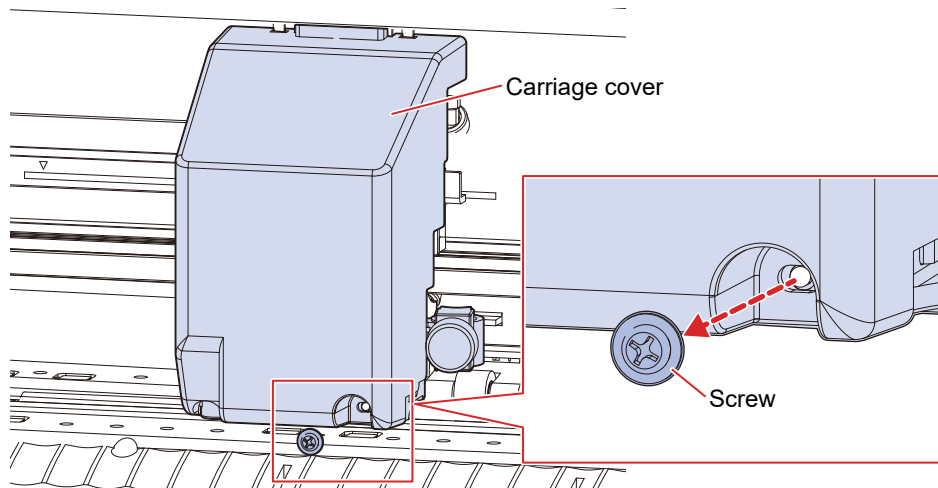

- (2) Lower the carriage cover.

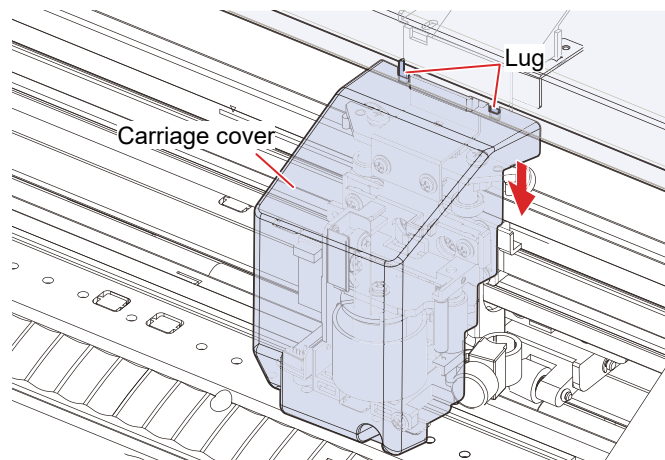

- (3) Pull the carriage cover diagonally out toward you, then detach from the lugs.

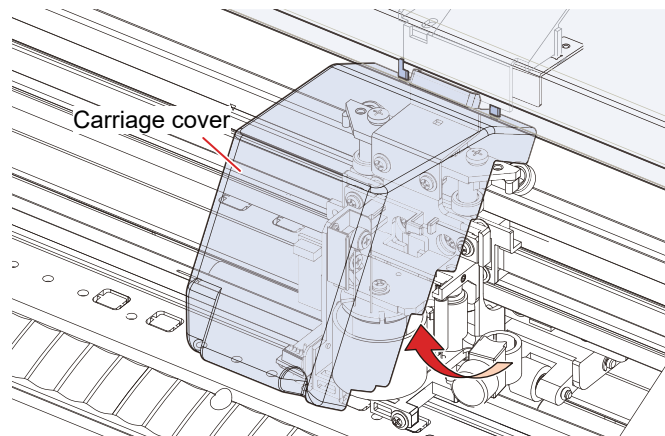

2 Insert the cutter guard into the pen shaft.

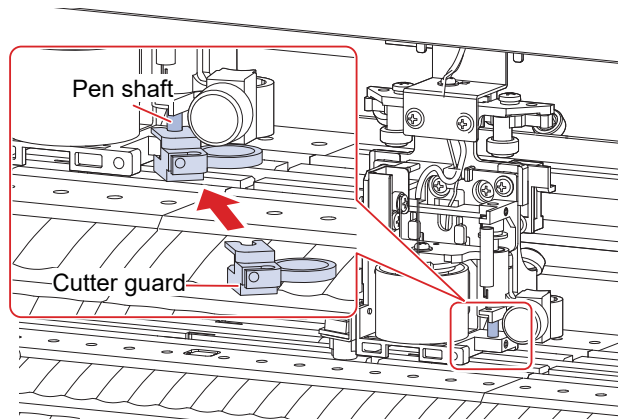

3 Rotate the cutter guard and engage the protrusion into the slot in the yoke-bracket.

- Push in until it engages with a click.

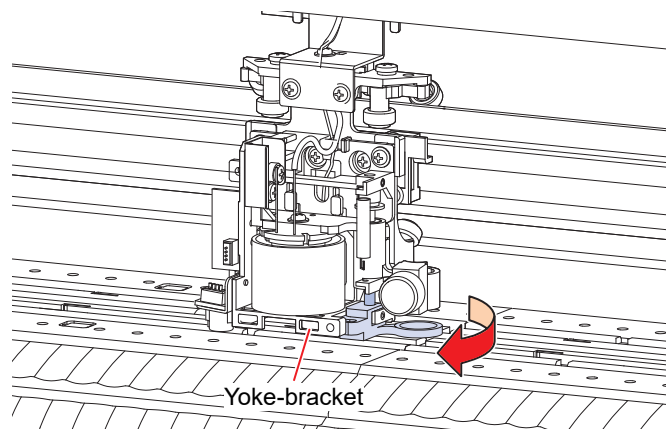

4 Reattach the carriage cover.

- (1) Mount the carriage cover diagonally, engaging the two holes in the carriage cover on to the two lugs on the machine.

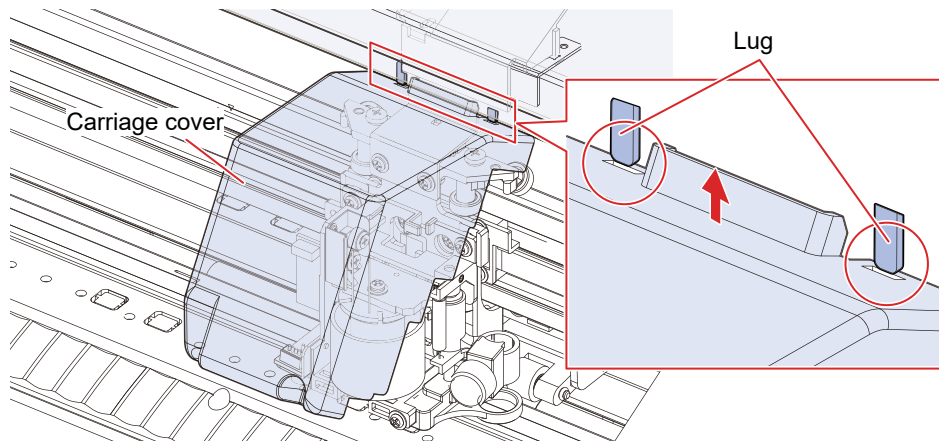

- (2) Lower the carriage cover until it is vertical, making sure it does not detach from the lugs.

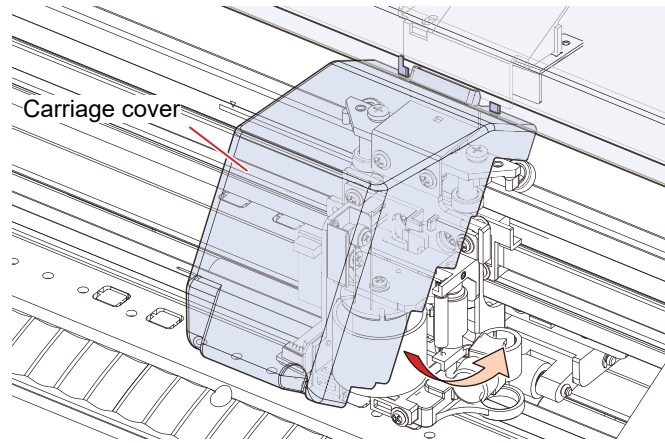

- (3) Lift the carriage cover to push it into the lugs.

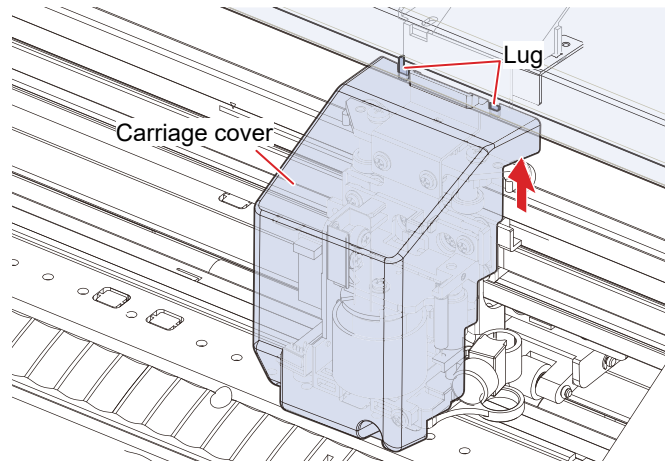

- (4) Reattach the screw into the screw hole in the carriage cover.
- If the screw hole is not aligned, remove and reattach the cover.

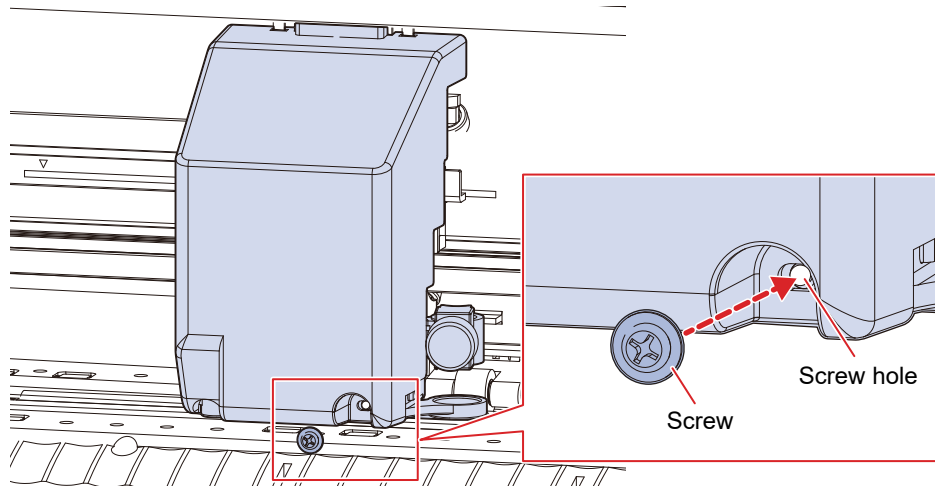

● Removing the cutter guard

1 Remove the pen-type cutter.

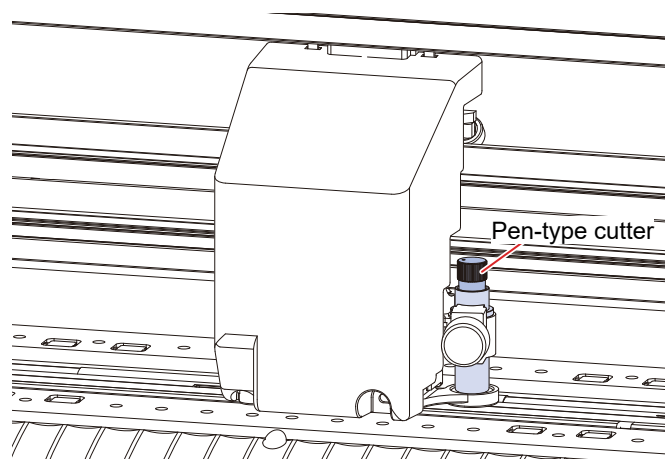

2 Remove the carriage cover.

- "Remove the carriage cover."(P. 17)

3 Remove the cutter guard from the pen shaft.

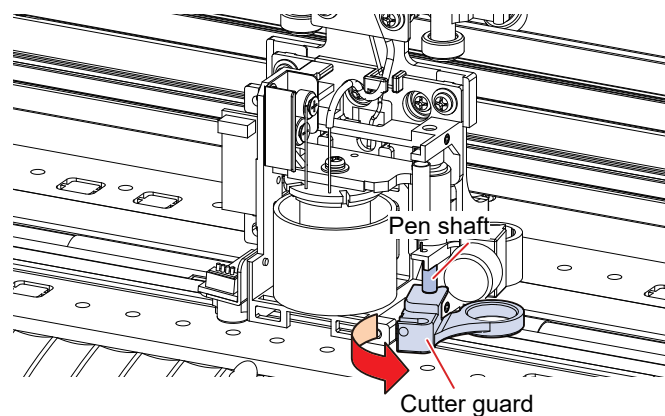

4 Reattach the carriage cover.

- "Reattach the carriage cover."(P. 18)

Installing Cutting Software and Plotter Driver

The following two Mimaki software applications are available for cutting:

Software name	Explanation
FineCut/Coat9	Plug-in software allowing processes from design to cutting data creation and output to a cutting plotter to be performed within Adobe® Illustrator®.
Simple POP	Design software allowing easy creation of POP data for printing and cutting.

The following driver is required for outputting data from Simple POP to a cutting plotter. It must be installed.

Software name	Explanation
Windows plotter driver	Printer driver allowing vector data to be extracted from data printed using an application and then output to a plotter.

For more information on how to install "FineCut/Coat9", "Simple POP", and the "Windows plotter driver", refer to the corresponding software reference guides, operation manuals, or instruction videos. The installers, reference guides, and operation manuals can be downloaded from the official Mimaki website.

<https://mimaki.com/download/software.html>

The instruction videos can be viewed at the following URLs:

<https://mimaki.com/product/cutting/c-roll/cg-srIII-series/video.html>

<https://mimaki.com/product/software/cutting/fine-cut9-ai/video.html>

Installing the Firmware Updater

The Mimaki Firmware Updater provides automatic notification of firmware update information for Mimaki products registered with this software, and allows product firmware connected to a computer to be updated to the latest version.

Updating enables issues such as faults with Mimaki products to be resolved. This software should be used to check the latest information.



- Do not turn off the plotter/printer power or disconnect the USB2.0 interface cable until the firmware version update has finished. Disregarding this precaution may prevent the plotter/printer from starting up.



- Connect only one plotter/printer. Version updating will not be possible if more than one plotter/printer is connected.

- 1 Select the plotter/printer you are using from the following download page:**
 - <https://mimaki.com/download/>
- 2 Select the [Driver/Utility] tab.**
- 3 Click "Mimaki Firmware Updater".**
- 4 Click the [Download] button at the bottom of the page to download to your computer.**
- 5 Double-click the downloaded exe file to decompress it.**
- 6 Double-click "setup.exe" in the decompressed folder.**
 - Reboot the computer.
- 7 Double-click "setup.exe" again after the computer has restarted.**
 - Installation starts.
- 8 Install in accordance with the on-screen instructions.**
 - A prompt to reboot appears on the screen again once installation is complete. Reboot the computer.



- For more information on how to register Mimaki products and update the firmware version, click [Mimaki Firmware Updater] - [Firmware Version Update Guide] on the Windows menu, to read the manual. The latest version can be downloaded and viewed at the following URL:
<https://mimaki.com/product/cutting/c-roll/cg-ar-series/download-manual.html>
-

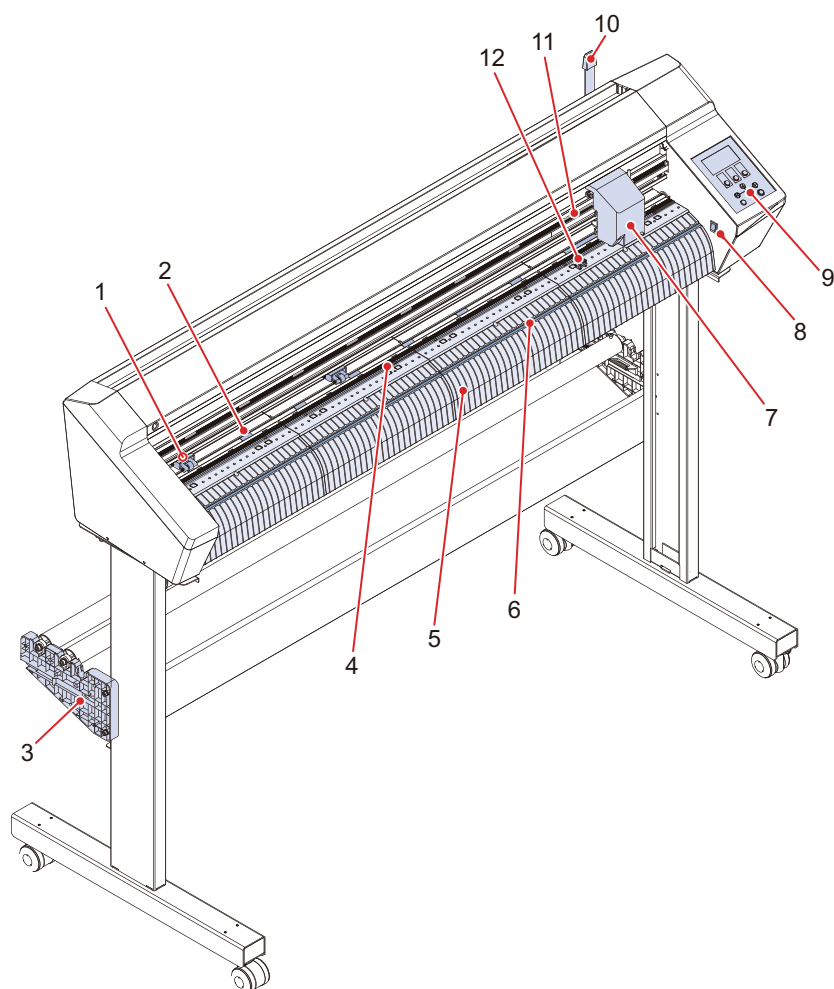

1.2 Part Names and Functions

Front



1

No.	Name	Outline
1	Pinch rollers	The pinch rollers and grit rollers grip the sheet to feed it. ☞ "Pinch Rollers and Grit Rollers"(P. 28)☞ "Moving the Pinch Rollers"(P. 55)
2	Grit roller	
3	Roll stay	Holds the roll bar. ☞ "Loading a Roll Sheet (CG-100/130AR)"(P. 52) (The legs are options available separately for the CG-60AR.)
4	Pen line	Area in which printing and cutting is performed. ☞ "Pen Line Rubber Replacement"(P. 148)
5	Platen	The sheet is moved along the platen.
6	Cutting slot	Used to cut sheets manually. ☞ "Separating Sheets (Manual Cutting)"(P. 75)
7	Carriage	Consists of a cutter unit for moving, raising, and lowering the pen and cutter.
8	Power supply switch	Turns the power on and off. ☞ "Turning On the Power"(P. 38)☞ "Turning Off the Power"(P. 38)
9	Operating panel	Includes operating keys and displays indicating various settings and other items. ☞ "Operating panel"(P. 30)
10	Clamp lever	Pulling the clamp lever forward secures the sheet. Pushing the clamp lever back releases the sheet.

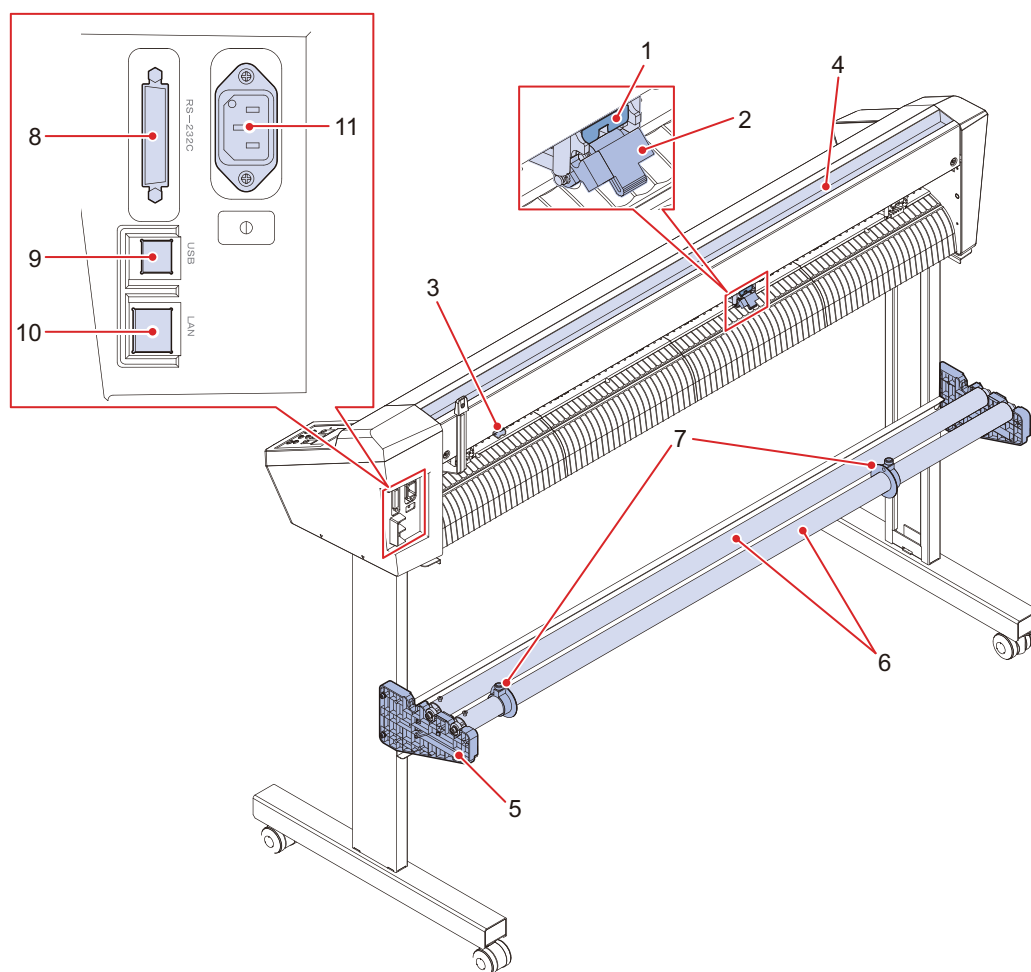

No.	Name	Outline
11	Pinch roller guide marks	Indicates the pinch roller setting position.  "Pinch Rollers and Grit Rollers"(P. 28)  "Moving the Pinch Rollers"(P. 55)
12	SHEET sensor	Detects whether a sheet is present and detects the sheet length.  "SHEET sensor"(P. 28)

Rear



1

No.	Name	Outline
1	Clamp pressure lever	Selects high or low pressure to clamp the sheet. "Clamp"(P. 28) "Setting the Clamp High/Low Mode"(P. 57)
2	Center clamp on/off lever	Enables and disables the center clamp. Disabling the center clamp offers the following benefits: "Enabling and Disabling the center clamp"(P. 57) <ul style="list-style-type: none"> • No marks are left on the sheet. • Prevents the sheet from lifting up.
3	SHEET sensor	Detects whether a sheet is present and detects the sheet length. "SHEET sensor"(P. 28)
4	Tray	Tray used for placing small items such as retractable knives and various types of cutters. "Tray"(P. 29)
5	Roll stopper (CG-100/130AR only)	Prevents the roll sheet from rotating when loading a sheet. "Loading a Roll Sheet (CG-100/130AR)"(P. 52) (The legs are options available separately for the CG-60AR.)
6	Roll bars	A roll sheet is loaded on top of the two bars. "Loading a Roll Sheet (CG-100/130AR)"(P. 52) (The legs are options available separately for the CG-60AR.)
7	Roll holder (CG-100/130AR only)	Clamps the two ends of a roll sheet. ""(P. 53)
8	RS-232C interface connector	An RS-232C interface connector. "Using an RS-232C Cable"(P. 34)

No.	Name	Outline
9	USB interface connector	A USB interface connector.  "Using a USB Cable"(P. 33)
10	LAN connector	A LAN connector.  "Using a LAN Cable"(P. 33)
11	AC inlet	Used to connect the power cable (provided).  "Connecting the Power Cable"(P. 36)

Carriage

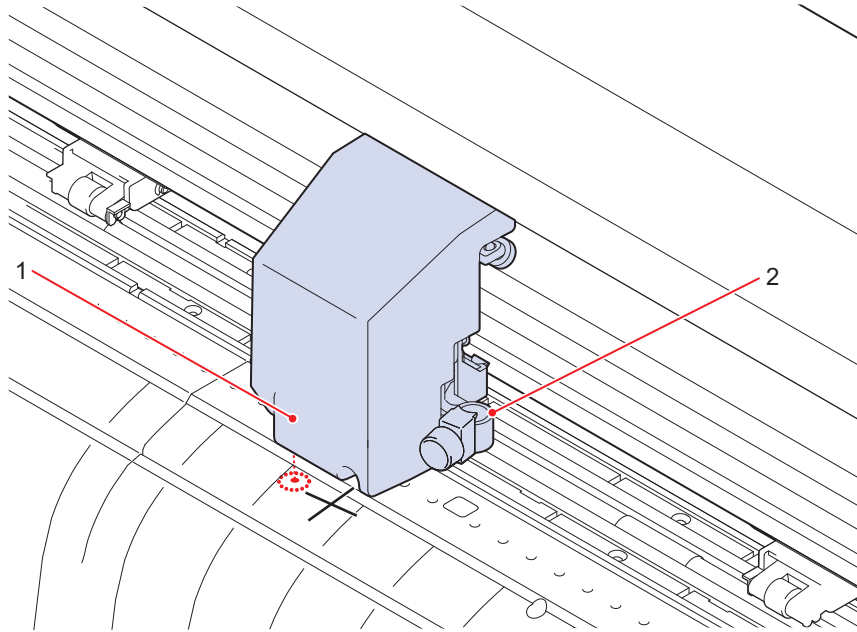

1

No.	Name	Outline
1	LED pointer	<p>The red LED pointer lights up in the following situations:</p> <ul style="list-style-type: none"> • Before sheet detection (Automatically goes out after sheet detection or if no sheet has been detected for 5 minutes.) • When reading register marks
2	Tool holder	Used to mount a pen-type cutter for cutting or water-based ballpoint pen for printing.

Pinch Rollers and Grit Rollers

The pinch rollers and grit rollers are used to grip and feed the sheet.

For more information, refer to  ["Moving the Pinch Rollers"\(P. 55\)](#).

For more information on the settings for the number of pinch rollers, refer to  ["Setting the Number of Pinch Rollers to Use"\(P. 56\)](#).

For more information on the sheet clamping pressure, refer to  ["Setting the Clamp High/Low Mode"\(P. 57\)](#).

SHEET sensor

The sheet sensors detect whether a sheet is present and detects the sheet length.

One sensor is located in front of the platen, and one sensor is located behind the platen.

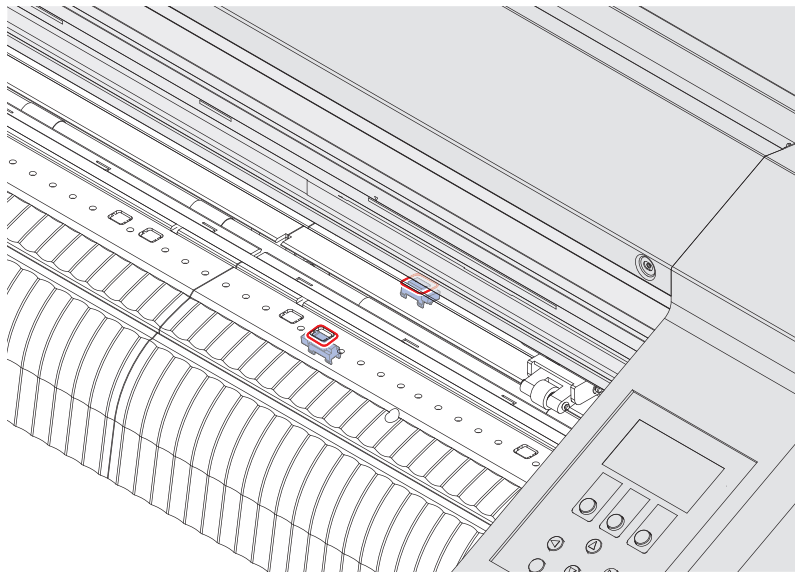

Clamp

The sheet clamping pressure can be switched between high mode and low mode using the clamp pressure lever.

Select high or low mode to suit the sheet being used.

For more information, refer to  ["Setting the Clamp High/Low Mode"\(P. 57\)](#).

Tray

Tray used for placing small items such as retractable knives.

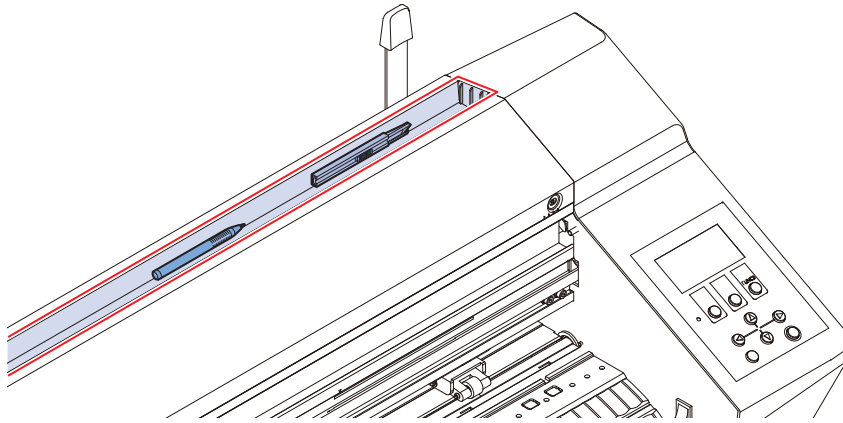

Important!

- Retractable knives and cutters are dangerous. Keep out of the reach of children.
- Do not place heavy items on the tray. Heavy items may cause the cover to deform and make contact with the carriage.

Operating panel

This is used to control the product and make/change settings.

Mimaki Remote Access can be used to operate the machine remotely from a computer or smartphone.

For more information, refer to Mimaki Remote Access online help.

<https://mimaki.com/product/software/remote/mimaki-remote-access/>



- The keys are designed for finger input. Do not use sharp or pointed objects, as this may damage the keys.

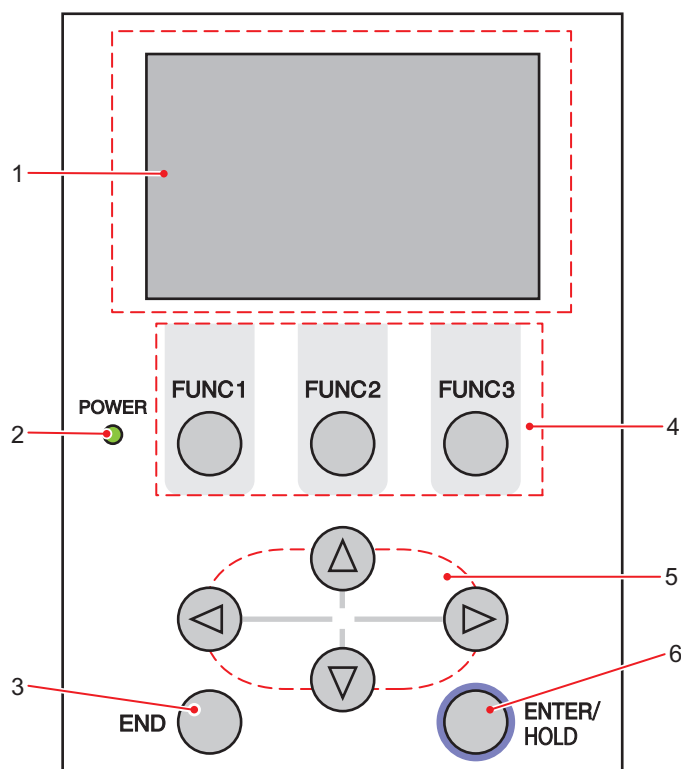

No.	Name	Outline
1	Display	Displays tool conditions such as speed, pressure, and offset, tool coordinates, functions, and error messages.
2	POWER lamp	Lights up when the machine power is turned on.
3	END key	Press to cancel the value entered or to return to the previous settings menu. Also used to detect the sheet width.
4	FUNCTION keys	Press to set individual functions. The functions assigned to FUNCTION 1 to FUNCTION 3 are indicated at the bottom of the display.
5	Jog keys	Press to move the carriage or sheet in the direction of the arrows or to select settings.
6	ENTER/HOLD key	Used to confirm operations and settings. Also used to correct sheet offsets during cutting (or printing). Pressing the [ENTER/HOLD] key on the "During remote control. [Ent]" screen aborts Mimaki Remote Access, and returns machine control to the operating panel.

● Note about jog keys

The functions of the jog keys change according to the situation.

	Before sheet detection	After sheet detection	When selecting a function	When entering a setting
◀	Detects sheet width and sheet front end	Moves carriage to left	-	-
▶	Detects sheet width and sheet length	Moves carriage to right	-	-
▲	Detects sheet width and sheet rear end	Moves sheet to rear of machine	Returns to previous function	Selects previous value
▼	Detects sheet width and sheet length	Moves sheet to front of machine	Moves to next function	Selects next value

In this manual, sheets other than roll sheets are referred to as "leaf sheets".

Display

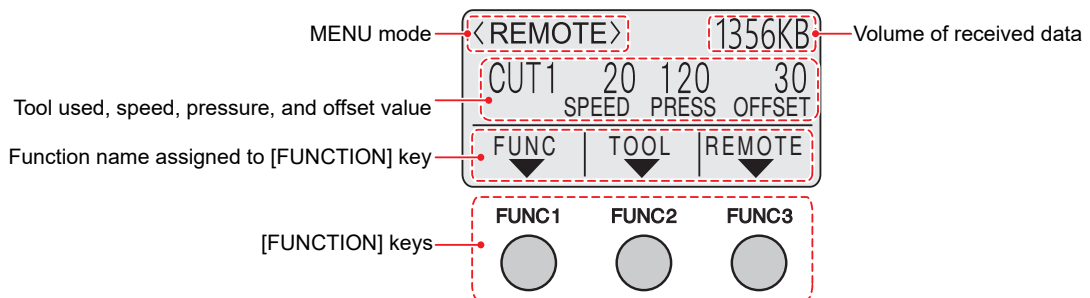

In this manual, the [FUNC1] key in this state is termed "[FUNCTION] key", [FUNC2] key is termed "[TOOL] key", and [FUNC3] key is termed "[REMOTE] key".

The volume of received data indicated at the top right decreases when cutting starts. "0KB" will be displayed if no uncut data remains.

MENU mode

There are three menu modes.

Name	Outline
LOCAL mode	The mode after sheet detection. All keys are enabled. Data can be received from the computer. However, data processing such as cutting (or printing) is not performed. (Error processing may be performed depending on the software.)
REMOTE mode	Cuts (or prints) the received data. Pressing the [REMOTE] key pauses cutting and switches to local mode. Pressing the [REMOTE] key again resumes cutting. Pressing the [ENTER/HOLD] key during cutting switches to [HOLD] mode.
NOT-READY mode	The mode before sheet detection. All keys except [REMOTE] are enabled.

[FUNCTION] keys

This section describes the functions and roles assigned to the [FUNCTION] keys.

Press one of the [FUNCTION] keys ([FUNC1], [FUNC2], or [FUNC3]) in local mode.

Some settings cannot be altered if uncut data remains. To alter settings, either end cutting or use [DATA CLEAR]. "Aborting Cutting (Data Clear)"(P. 74)

Display	Outline
FUNC	Pressing the [FUNC1] key displays the setting screens.
TOOL	Pressing the [FUNC2] key displays the tool condition selection screen or tool condition setting screen.
REMOTE	Pressing the [FUNC3] key switches from local mode to remote mode.

1.3 Connect host computer to machine.

Connect a host computer (computer on which the cutting software is installed) to this machine using a USB cable, LAN cable, or RS-232C cable.



- Communication conditions must be set to suit the type of interface used.
- Plug in and unplug cables carefully. Excessive force may damage the cables.

Using a USB Cable

Connect a host computer to this machine using a USB interface cable.

The Mimaki USB driver is required when connecting using a USB cable. The USB driver can be installed when setting up FineCut/Coat9.

For more information, refer to the FineCut/Coat9 reference guide.



- Do not unplug the cable while data is being transferred.



- If the PC does not have a USB port, contact your local distributor, our sales office, or service center.

USB Connection Precautions

Check the following three precautions where applicable:

● When connecting more than one CG-AR to a PC

The CG-AR may not be correctly recognized.

If the PC has more than one USB port, try connecting to a different USB port to check whether the product is correctly recognized. If the product is still unrecognized even when connected to a different USB port, use a commercially-available USB active repeater cable.

● When extending the USB cable

Use a commercially-available USB active repeater cable. However, make sure that the combined length of the USB cable and the USB active repeater cable does not exceed 20 m.

Data transfer may take longer if the USB cable is extended, and may temporarily halt the carriage during cutting.

● USB high-speed mode peripheral devices

It may not be possible to recognize USB peripheral devices if USB high-speed mode peripheral devices (e.g., USB memory, USB HDD devices) are connected to the PC to which the product is connected. Data transfer may take longer if external USB hard disk drives or similar devices are connected, and may halt the carriage during cutting.

Using a LAN Cable

Connect a host computer to this machine using a LAN cable. Insert a LAN cable until it engages with a click.



- Do not unplug the cable while data is being transferred.

● Network Connection Precautions

Make sure the network is set up as follows: Cutting will not be possible if the network is not set up correctly.

- Use a Category 5 or higher LAN cable.
- The host computer must be located on the same network as this machine. This product cannot be connected via a router.
- Use a 100BASE-TX compatible computer or switching hub. Cutting requires 1000BASE-TX support.

● Checking the LAN connection

1 Check the lamp on the LAN connector.

- The LAN connector lamp illuminates when this machine is running.

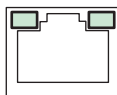

Color	Status	Outline
Green	Flashing	Data is being sent or received.
Orange	Illuminated	Linked up (connected).
	Off	Link down (not connected)

Using an RS-232C Cable

Connect a host computer to this machine using an RS-232C cable.



- Turn off power to both this machine and the host computer before connecting the cable.



- Do not unplug the cable while data is being transferred.

Setting the Computer Connection Conditions

Set the communication conditions for the RS-232C interface.

The communication condition settings differ according to the command (AUTO, MGL-Ic1, MGL-IIc) set using command switching.



- If the step size has been altered, be sure to raise the pinch rollers using the clamp lever and reload the sheet.

1 Press the [FUNCTION] in local mode, press ▲▼ to select [SET UP], then press the [ENTER/HOLD] key.

2 Press ▲▼ to select [INTERFACE], then press the [ENTER/HOLD] key.

3 Press ▲▼ to select [BAUD RATE] setting value, then press the [ENTER/HOLD] key.

- Settings: 1200, 2400, 4800, 9600, 19200, 38400 (bps)



- The recommended setting is 38400.
- Set the host computer transfer speed to suit the CG-AR.

- 4 Press **▲▼** to select the following communication conditions in turn, then press the **[ENTER/HOLD]** key.
 - Press **▲▼** to select the setting, then press the **[ENTER/HOLD]** key to display the following items. Repeat the steps in turn until all settings have been set.
 - Communication conditions: Data bits, parity, stop bit, handshake, step size, close time
- 5 Press **▲▼** to select the setting, then press the **[ENTER/HOLD]** key.
 - For more information on the individual settings, refer to  "Notes on the setting items"(P. 35).
- 6 Press the **[END]** key several times to exit.

Notes on the setting items

BAUD RATE	1200, 2400, 4800, 9600, 19200, 38400 (bps)	
Data bits	7, 8 (bit)	
Parity	NON, EVEN, ODD	
Stop bits	1, 2 (bit)	
Handshake	AUTO (MGL-IIc)	HARD, ENQACK, X-PRM, SOFT
	MGL-IIc	HARD, ENQACK, X-PRM, SOFT
	MGL-Ic1	HARD, XONOFF
Step size	AUTO (MGL-IIc)	0.025 (mm)
	AUTO (MGL-Ic1)	0.05 (mm)
	MGL-IIc	0.025, 0.01 (mm)
	MGL-Ic1	0.05, 0.025, 0.1 (mm)
Close time ^{*1}	3 to 60 (Seconds)	

*1. Sets the data interval for multiple sheet cutting, and the waiting time before start of dividing cutting or sorted output. The value can be set from 3 to 60 seconds. If no data is received within the time set after cutting has ended, it is determined that one set of data has ended, allowing separation from the next set of data.

1.4 Connecting the Power Cable

1 Check to confirm that the machine power supply is off.

-  "Turning Off the Power"(P. 38)

2 Attach the power cable clamp (accessory).

- Insert the power cable clamp into the power cable clamp hole.
- Check that the power cable clamp is securely attached by tugging on it.

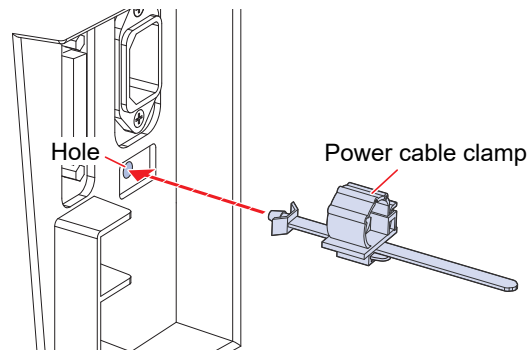

3 Plug the power cable into the inlet of the machine.

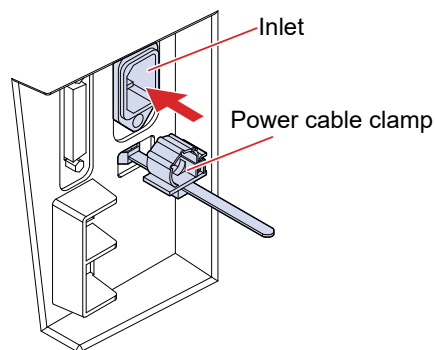

4 Slide the power cable clamp out to an appropriate position.

- To slide the power cable clamp out, push up the tab underneath.
- The tab does not need to be pushed up when sliding the power cable clamp in.

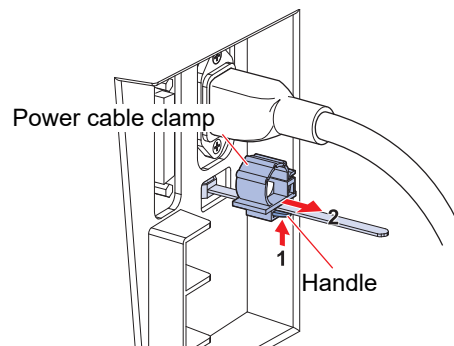

5 Pass the power cable through the power cable clamp to secure it in place.

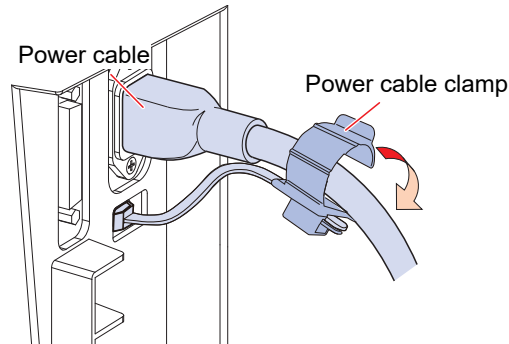

6 Slide the power cable clamp in.

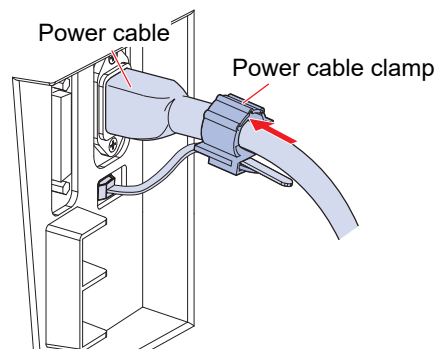

7 Plug the power plug into the power outlet.



- Do not handle the power plug with wet hands. Disregarding this precaution may result in electric shock.



- Be sure to ground the machine. It is extremely dangerous to use the machine without grounding it, due to the risk of electric shock or machine damage.

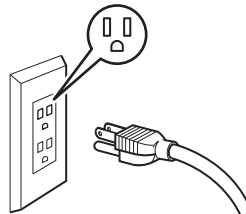

- When using a two-pin power outlet, insert the plug of the power cable into the ground adapter provided.

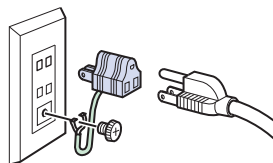

- Connect the green wire (ground wire) of the ground adapter to ground. If grounding is not possible, contact an electrical contractor for assistance.

Turning On the Power



- Before turning on the power, check to confirm that the pinch rollers are raised.
- Turn on the host computer first, then turn on power switch for this machine on. A malfunction may occur if power is not turned on in this sequence.
- Wait at least 5 seconds after turning off power before turning it on again.

1 Turn on the power to the host computer.

2 Turn the power switch to "I".

- Modes can be selected after the power has been turned on. Refer to  "MENU mode"(P. 31).
- The blue POWER lamp lights up.
- Initialization is performed.

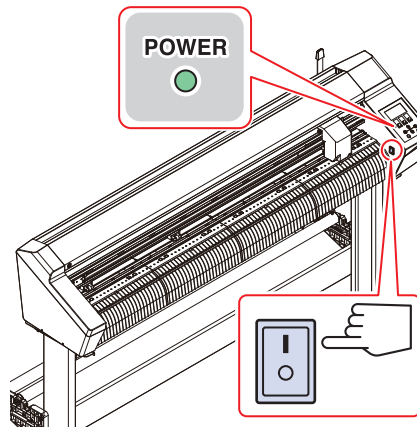

3 The currently selected tool conditions are displayed once origin detection is complete.

Turning Off the Power



- Wait at least 5 seconds after turning off power before turning it on again.
- Check to confirm that data is not being received before turning off the power.

1 Turn the power switch to "O".

- The POWER lamp on the operating panel goes out.
- Check to confirm that the machine power supply has turned off.

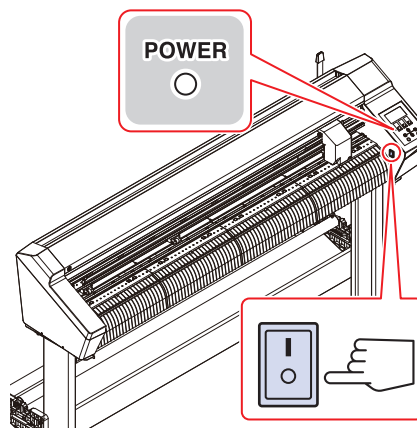

- 2 Shut down the computer connected to the machine.

1.5 System Configuration

This machine cuts using cutting data created with applications such as FineCut/Coat9 and SimplePOP.

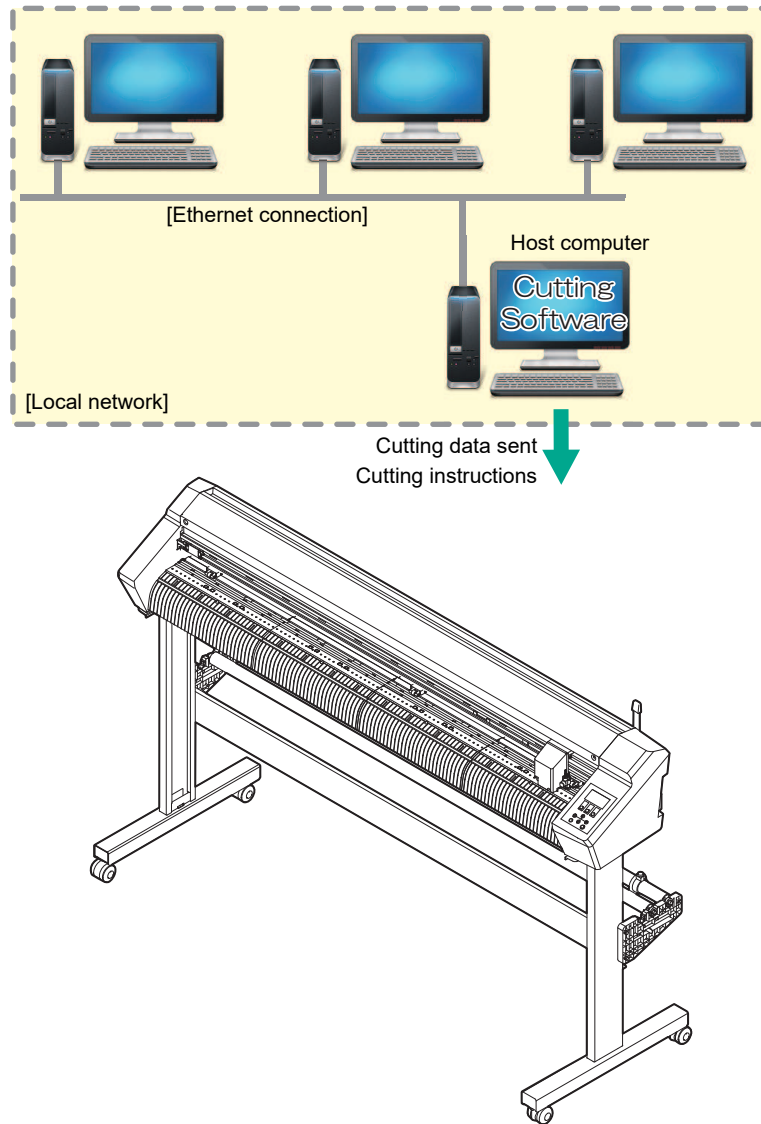

Chapter 2 Cutting



This chapter



Describes cutting procedures and setting methods.

Cutting Process	42	Selecting Tool Conditions.....	68
Loading a Sheet	44	Setting Tool Conditions	69
Loading a Leaf Sheet (Cut Sheet).....	47	Test Cutting	72
Loading a Roll Sheet (CG-60AR).....	48	Cut the data.....	73
Loading a Roll Sheet (CG-100/130AR).....	52	Setting the Origin	73
Pinch Roller Position/Number and Clamp		Starting Cutting	73
Settings	55	Pausing Cutting.....	74
Installing Tools	59	Aborting Cutting (Data Clear).....	74
Using the Cutter	59	Retracting the Carriage	74
Using a Pen.....	63	Separating Sheets (Manual Cutting)	75
Using the Creasing Tool.....	67		

2.1 Cutting Process

1. Start up host computer (computer on which the cutting software is installed).



2. Connect host computer to machine.

-  ["Using a USB Cable"\(P. 33\)](#)
-  ["Using a LAN Cable"\(P. 33\)](#)
-  ["Using an RS-232C Cable"\(P. 34\)](#)

3. Turn on the power.

-  ["Turning On the Power"\(P. 38\)](#)

4. Loading a Sheet

Roll sheet or leaf sheet (cut sheet) can be used.  ["Loading a Sheet"\(P. 44\)](#)
Adjust the pinch roller positions to suit the sheet width.  ["Pinch Rollers and Grit Rollers"\(P. 28\)](#)

5. Installing Tools

A cutter, ballpoint pen, or creasing tool (option) can be used.
 ["Installing Tools"\(P. 59\)](#)

6. Selecting Tool Conditions

-  ["Selecting Tool Conditions"\(P. 68\)](#)

7. Setting Tool Conditions

Set the cutting speed and pressure to match the type of sheet and tools used.
 ["Setting Tool Conditions"\(P. 69\)](#)

8. Test Cutting

Perform a test cut to confirm tool conditions are appropriate.  ["Test Cutting"\(P. 72\)](#)

9. Cut the data.

-  ["Cut the data."\(P. 73\)](#)

10. Separate sheets.

Cut the sheets manually.  ["Separating Sheets \(Manual Cutting\)"\(P. 75\)](#)

11. Turn off machine power.

 ["Turning Off the Power"\(P. 38\)](#)

2.2 Loading a Sheet

Load a leaf sheet (cut sheet) or roll sheet, then pull the clamp lever toward you to clamp the sheet between the pinch and grit rollers.

For more information, refer to  ["Loading a Roll Sheet \(CG-60AR\)"\(P. 48\)](#) and  ["Loading a Roll Sheet \(CG-100/130AR\)"\(P. 52\)](#)  ["Loading a Leaf Sheet \(Cut Sheet\)"\(P. 47\)](#).



- Two people at minimum are needed to load a roll sheet. Otherwise back injuries may result due to the weight of the sheet.



- This machine has three pinch rollers. Position one pinch roller at each edge of the sheet and one in the middle when loading thin sheets, wide sheets, or sheets with slippery surfaces such as film. The middle pinch roller is not needed when using narrower sheets.
- Marks may be left on the sheet by the grit rollers when the middle pinch roller is used.  ["Clamp"\(P. 28\)](#)

● Compatible sheet widths

Model Name	mm	inch
CG-60AR	90 to 740	3.55 to 29.10
CG-100AR	90 to 1250	3.55 to 49.20
CG-130AR	90 to 1550	3.55 to 61.00

● Note about the cutting area

The maximum cutting area (cutting (printing) range) is determined by the positions of the pinch rollers and origin ( ["Setting the Origin"\(P. 73\)](#)). White areas in the following diagrams indicate the maximum cutting areas.

Areas outside these, where cutting is not possible, correspond to non-plotting areas.

In expand mode, the area extending to the outside edge of the pinch rollers is detected. Normally the area to the inside edge of the pinch rollers is detected. ( ["Expanding the Cutting Area \[EXPANDS\]"\(P. 108\)](#))

Model Name	With origin set at bottom right	With origin set at center
CG-60AR	0.606m x 51m	0.606m x 5m
CG-100AR	1.07m x 51m	1.07m x 5m
CG-130AR	1.37m x 51m	1.37m x 5m

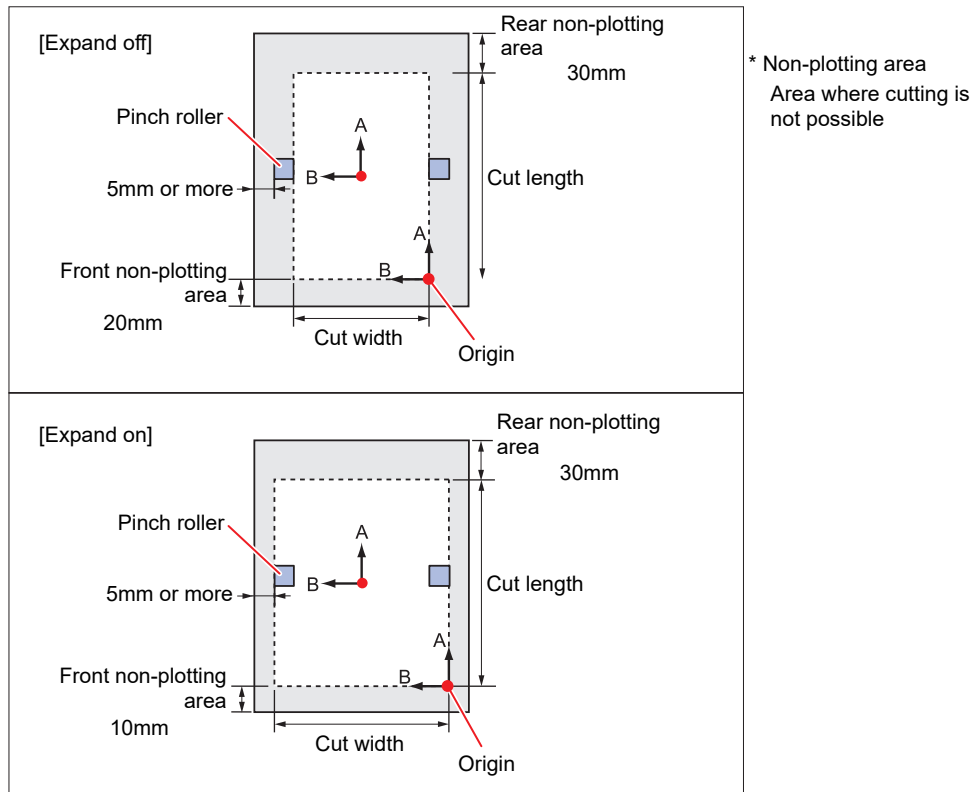

● Note about sheet detection

The jog keys or [END] key can be used to detect the width and length of the loaded sheet.

Important!

- When using sheet length detection, if the data indicates a size larger than the actual sheet, parts protruding beyond the sheet cannot be cut. Without sheet length detection, the cutting operation will stop as soon as data extends beyond the sheet.
- If sheet sensing is disabled, the same detection (only sheet width detection) as when the [END] key is pressed will be performed, even if the jog keys are used.
- The maximum detection length to the rear edge of the sheet is 5 m.

● Sheet detection method

The display appears as follows when a sheet is loaded.

Press the jog keys to suit the orientation of the sheet loaded.

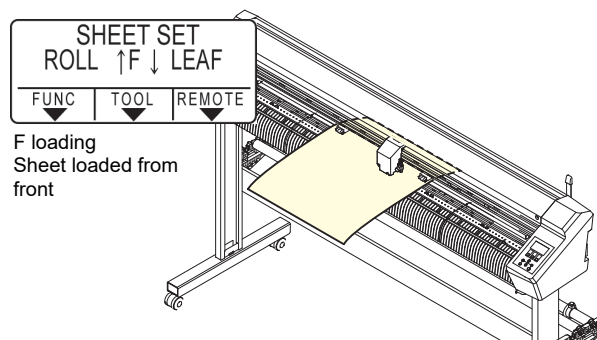
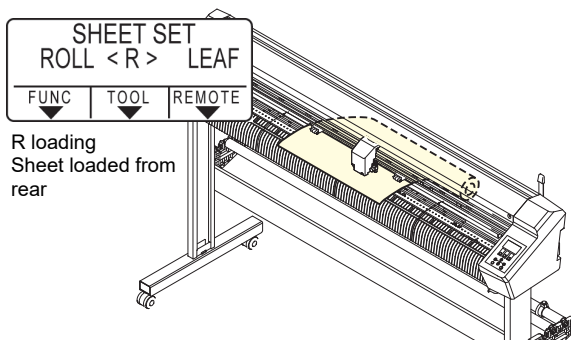

Sheet detection can be performed using any of the following five methods.

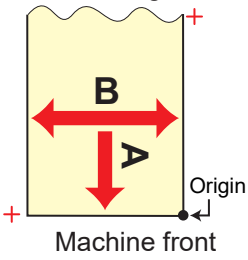
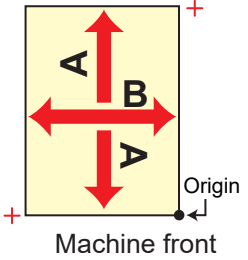
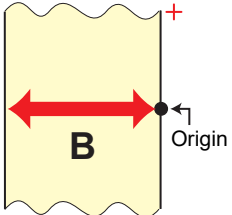
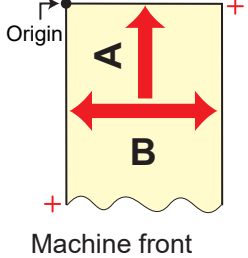
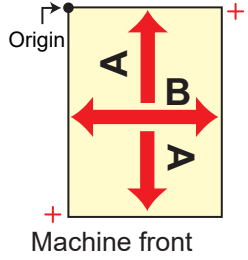
Key	⏪ Roll sheet set to rear	⏩ Leaf sheet set to rear	[END] Sheet width detection only
Detection method	Sheet width detected, then sheet front edge detected 	Sheet width detected, then sheet front and rear edges detected 	Sheet width detected 
Example sheet size display after detection	<pre><LOCAL> A *.*.* B 123.0 ----- FUNC TOOL REMOTE</pre>	<pre><LOCAL> A 567.0 B 123.0 ----- FUNC TOOL REMOTE</pre>	<pre><LOCAL> A ***** B 123.0 ----- FUNC TOOL REMOTE</pre>
Key	⏴ Roll sheet set to front	⏵ Leaf sheet set to front	
Detection method	Sheet width detected, then sheet rear edge detected 	Sheet width detected, then sheet front and rear edges detected 	
Example sheet size display after detection	<pre><LOCAL> A ***** B 123.0 ----- FUNC TOOL REMOTE</pre>	<pre><LOCAL> A ***** B 123.0 ----- FUNC TOOL REMOTE</pre>	

Important!

- The detected size is displayed as "*****" if 3 m or greater.
- If using the [END] key, in which only sheet width is detected, or if the rear edge of a roll sheet is not detected, do not over-feed the sheet with the jog keys ⏴ ⏵ or when cutting data extending beyond sheet edges, as the sheet may fall out.
- Note that the positive directions for each axis will vary as shown in the diagrams above, depending on the direction in which the sheet was loaded.
- Sheet detection has the same effect as using DATA CLEAR. Even if data is sent before detection and switched to remote after sheet detection, cutting will not start, as the data has been cleared. (Data can still be copied.)
- If using "Leaf Mode" in FineCut/Coat9 for continuous register mark cutting, be sure to perform sheet detection in [Leaf Mode].
- If the sheet front edge is not detected, a parameter error will occur, and the system will not switch to copy mode.



- Sheet detection may take some time when using long sheets or when using a sheet from midway with it pulled out.
- In such cases, detection time can be reduced by pressing the [END] key to detect only sheet width.

Loading a Leaf Sheet (Cut Sheet)

1 Push back the clamp lever to raise the pinch rollers.

2 Pass the sheet through the platen.

- Insert the sheet between the pinch rollers and the grit rollers.
- Either align the right edge of the sheet, using the vertical ribs on the platen, or align the front of the sheet to be parallel with the platen.

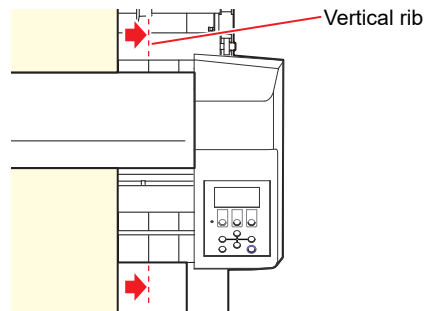

3 Move the pinch rollers to suit the sheet width.

- ["Pinch Rollers and Grit Rollers"\(P. 28\)](#)
- Move the pinch rollers to be at least 5 mm inside the sheet edges. Incorrect positioning may cause the sheet to become offset during sheet feeding.

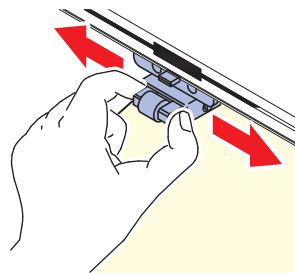

4 Set the clamps at both edges to High mode.

- ["Setting the Clamp High/Low Mode"\(P. 57\)](#)

5 If using three pinch rollers, select High mode or Low mode for the center clamp as appropriate to suit the sheet being used.

- ["Setting the Clamp High/Low Mode"\(P. 57\)](#)

6 The center clamps can be enabled or disabled when using three pinch rollers.

- ["Enabling and Disabling the center clamp"\(P. 57\)](#)
- The center clamp should be enabled (center clamp up) if you do not wish leave pinch roller marks on the sheet.

7 Pull the clamp lever toward you.



8 Check to confirm that the pinch rollers are evenly spaced.

- Hold the sheet between the pinch rollers and grit rollers.



- If the spacing is not uniform, repeat all steps from the start.

9 Press or to select [LEAF].

-  "Note about sheet detection"(P. 45)
- : If the sheet was loaded from the rear of the machine
- : If the sheet was loaded from the front of the machine

Important! • Pressing the [FEED] key displays a screen for selecting the number of pinch rollers before sheet detection. Select the number of pinch rollers before performing sheet detection. The number of pinch rollers set here takes precedence over the number of pinch rollers using the [SET UP] - [PINCH ROLL.] menu.

10 Press to select the number of pinch rollers to be used.

- If [ROLL. SELECT] is set to [ON], select the number of pinch rollers to use.  "Setting the Number of Pinch Rollers to Use"(P. 56)

11 Start sheet detection.

- If [DUMMY CUT] is set to [ON], a dummy cut is performed after sheet detection is complete.  "DUMMY CUT"(P. 140)
- Detection is not possible for leaf sheets of 5 m or longer length.

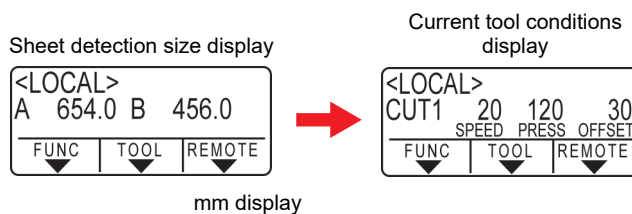

Loading a Roll Sheet (CG-60AR)

When using a roll sheet, the roll-placing tables or optional CG-60AR legs must be attached.

● Attach the roll-placing tables.

1 Insert the roll-placing table into the slot at the rear of the machine.

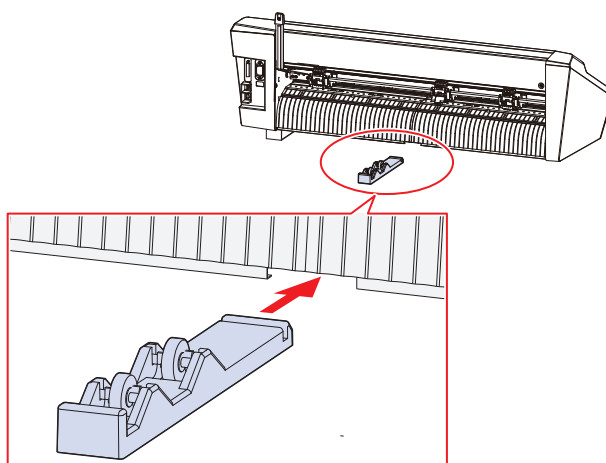

- 2** Align the slots in the roll-placing table with the groove underneath the machine and slide to the left or right to attach.

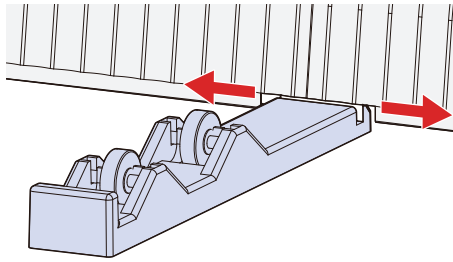

- The figure below shows the roll-placing table attached after sliding it to the left.

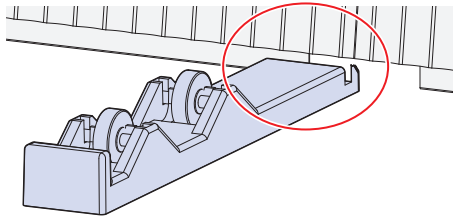

- 3** Attach the other roll-placing table to the machine in the same way.
- 4** Adjust the roll-placing table positions to suit the roll width.

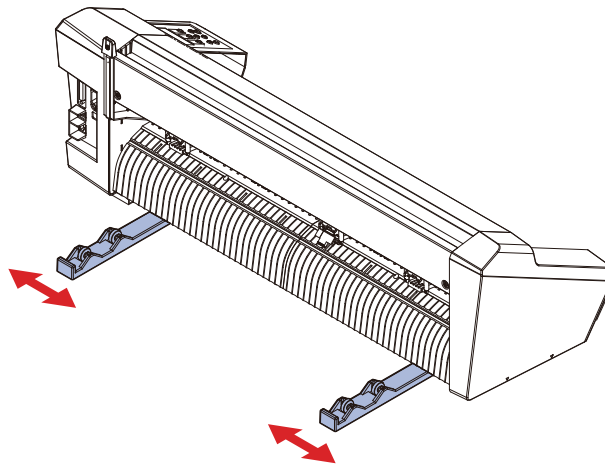

● **Attach the optional CG-60AR legs.**

For more information on how to attach the optional CG-60AR legs, refer to the assembly instructions provided with the legs.

● Load a roll sheet.

1 Place a roll sheet on the roll-placing tables or roll bars (the legs are optional).

- Be sure to mount with the sheet facing in the correct direction.

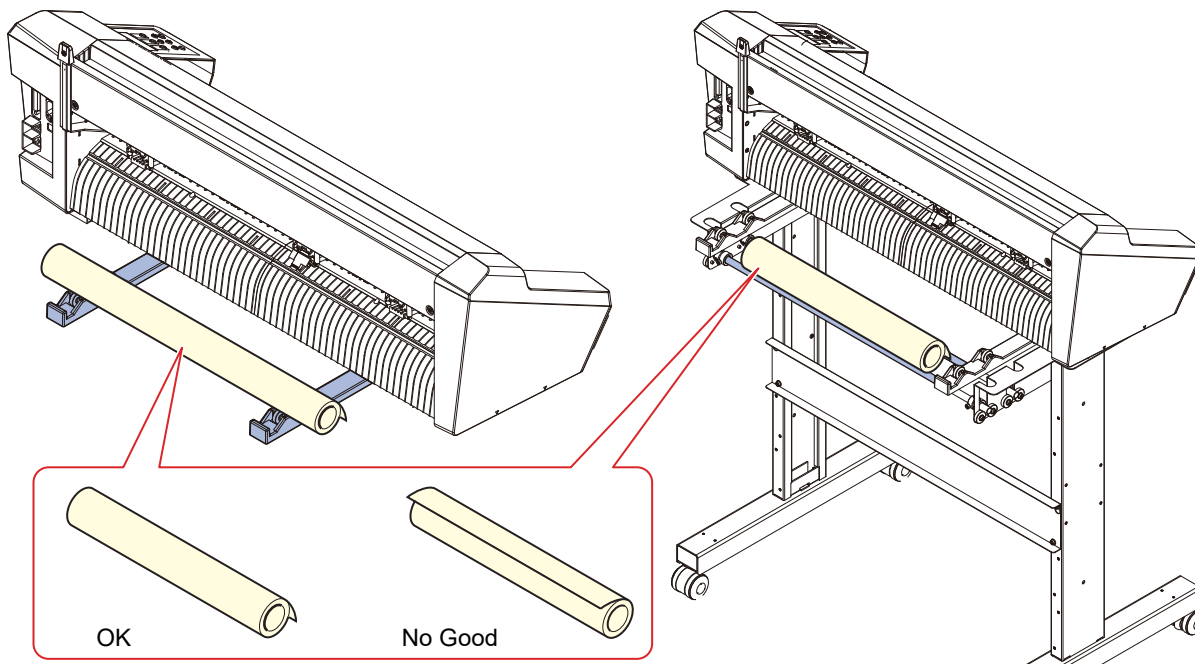

2 Push back the clamp lever to raise the pinch rollers.

3 Pass the sheet through the platen.

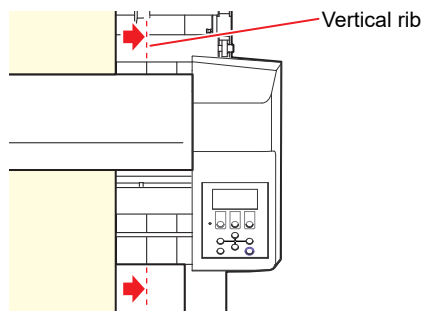

- Insert the sheet between the pinch rollers and the grit rollers.
- Align the right edge of the sheet using the vertical ribs on the platen.

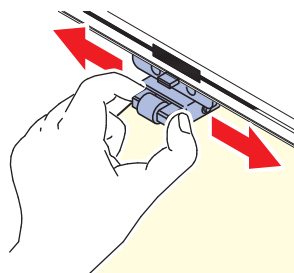

4 Move the pinch rollers to suit the sheet width.

- 🖱️ ["Moving the Pinch Rollers"\(P. 55\)](#)
- Move the pinch rollers to be at least 5 mm inside the sheet edges. Incorrect positioning may cause the sheet to become offset during sheet feeding.



- 5 Set the clamps at both edges to High mode.
 -  "Setting the Clamp High/Low Mode"(P. 57)
- 6 If using three pinch rollers, select High mode or Low mode for the center clamp as appropriate to suit the sheet being used.
 -  "Setting the Clamp High/Low Mode"(P. 57)
- 7 The center clamps can be enabled or disabled when using three pinch rollers.
 -  "Enabling and Disabling the center clamp"(P. 57)
 - The center clamp should be enabled (center clamp up) if you do not wish leave pinch roller marks on the sheet.
- 8 Pull out the sheet tight to eliminate any sagging.
- 9 Check to confirm that the sheet has been loaded without any sagging, then pull the clamp lever toward you.

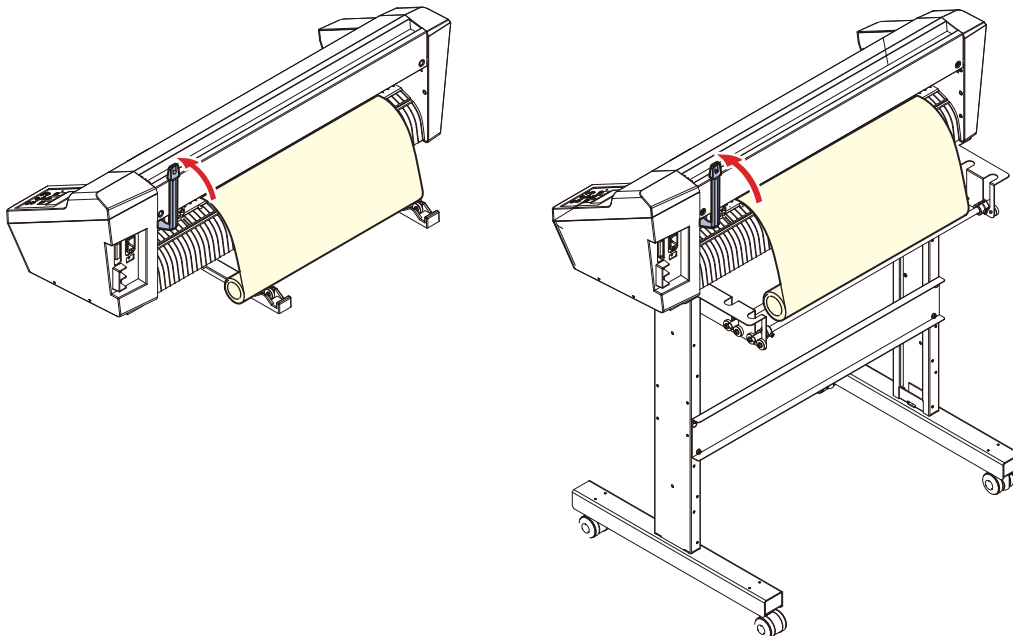



10 Check to confirm that the pinch rollers are evenly spaced.

- Hold the sheet between the pinch rollers and grit rollers.



- If the spacing is not uniform, repeat all steps from the start.

11 Press or to select [ROLL].

-  "Note about sheet detection"(P. 45)
- : If the roll sheet was loaded from the rear of the machine
- : If the roll sheet was loaded from the front of the machine



- Pressing the [FEED] key displays a screen for selecting the number of pinch rollers before sheet detection. Select the number of pinch rollers before performing sheet detection. The number of pinch rollers set here takes precedence over the number of pinch rollers using the [SET UP] - [PINCH ROLL.] menu.

12 Press ▲▼ to select the number of pinch rollers to be used.

- If [ROLL. SELECT] is set to [ON], select the number of pinch rollers to use. (👉) ["Setting the Number of Pinch Rollers to Use"](#)(P. 56)

13 Start sheet detection.

- If [DUMMY CUT] is set to [ON], a dummy cut is performed after sheet detection is complete. (👉) ["DUMMY CUT"](#)(P. 140)

14 Use [SHEET FEED] to pull out the length of sheet to be used. (👉) ["Sheet Feed"](#)(P. 120)

- Before using the roll sheet, make sure that there is sufficient sheet for the length to be used. Feeding the sheet reduces offset when cutting and also allows you to check in advance that the sheet is not askew.

Loading a Roll Sheet (CG-100/130AR)

When using a roll sheet, the roll stays must be attached.

For more information on how to attach the roll stays, refer to the assembly instructions provided or see the video (👉) ["Assembling the Legs and Sheet Basket"](#)(P. 16)).

1 Mount the roll bars on the roll stay assembly.

- Mount the roll bars with the ends with lugs at the right-hand side, when viewed from the rear of the machine. Mount the roll bars in the numbered slots as follows to suit the outer diameter of the roll sheet:
- For roll sheet with a diameter of 75 mm or more, mount in slots 1 and 3.
- For roll sheet with a diameter of less than 75 mm, mount in slots 2 and 3.

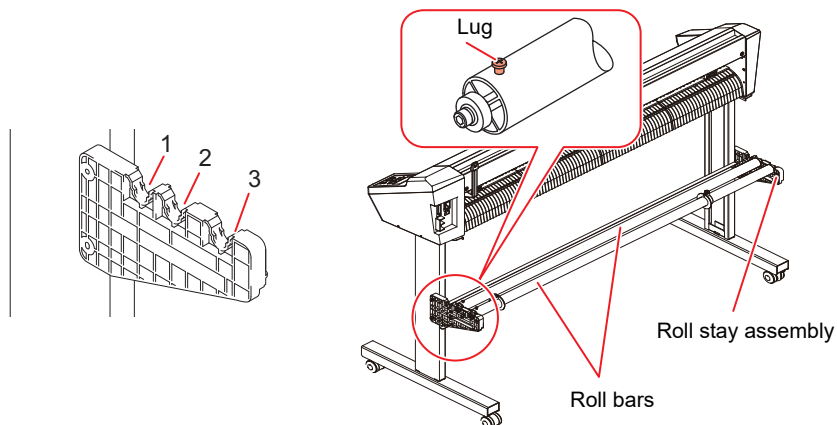



- Check that the roll bars have been installed level.
- When moving roll bars to different slots, keep them level when lifting them. There is a risk of damaging the roll stay assembly if the roll bars are lifted at an angle.

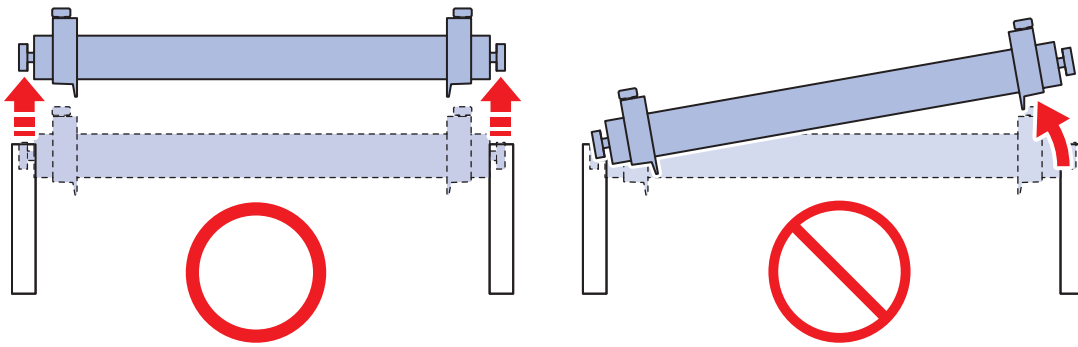

2 Clamp the roll sheet using the roll holders.

- Slide the roll holders to both ends of the sheet and tighten the screws to clamp them in place.
- Clamp the roll holders leaving a gap of 2 to 3 mm from the sheet edges. The roll will not be able to rotate and sheet feeding may not be possible if both edges are tightly clamped.

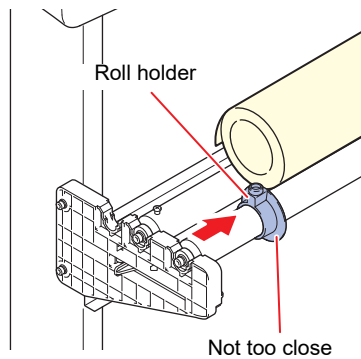

3 Lock the roll stopper.

- Push the roll stopper lever toward the rear of the machine to lock in place.
- The roll stopper prevents the sheet from rotating when the roll sheet is pulled out.

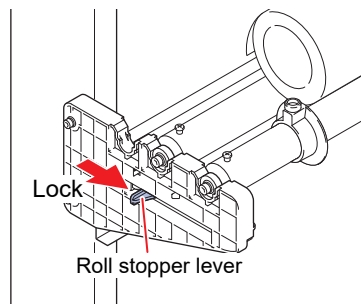

4 Place a roll sheet on the roll bars.

- Be sure to mount with the sheet facing in the correct direction.

5 Push back the clamp lever to raise the pinch rollers.

6 Pass the sheet through the platen.

- Insert the sheet between the pinch rollers and the grit rollers.
- Align the right edge of the sheet using the vertical ribs on the platen.

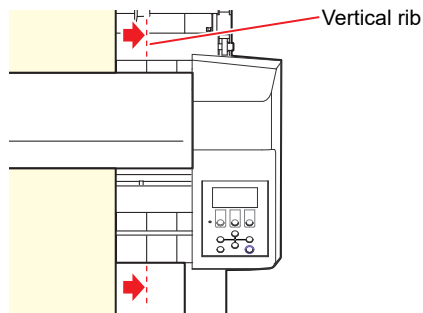

7 Move the pinch rollers to suit the sheet width.

- ["Pinch Rollers and Grit Rollers"\(P. 28\)](#)
- Move the pinch rollers to be at least 5 mm inside the sheet edges. Incorrect positioning may cause the sheet to become offset during sheet feeding.

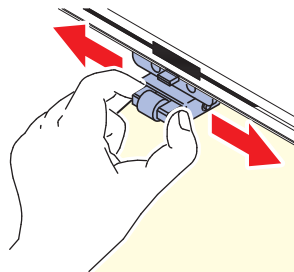

8 Set the clamps at both edges to High mode.

- ["Setting the Clamp High/Low Mode"\(P. 57\)](#)

9 If using three pinch rollers, select High mode or Low mode for the center clamp as appropriate to suit the sheet being used.

- ["Setting the Clamp High/Low Mode"\(P. 57\)](#)

10 Pull out the sheet tight to eliminate any sagging.

11 Check to confirm that the sheet has been loaded without any sagging, then pull the clamp lever toward you.

- If the power is on, the vacuum fan operates and sucks up the roll sheet.
- If the power is not on, the vacuum fan will not operate. In which case, pull the clamp lever toward you while supporting the sheet with your other hand to prevent it distorting.

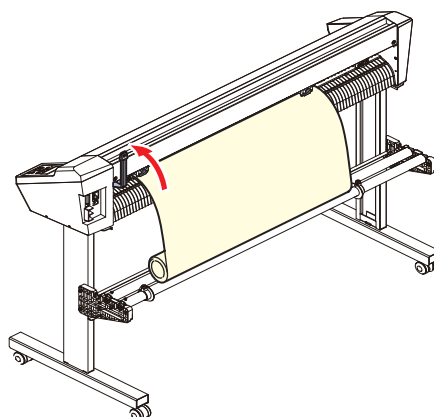

12 Check to confirm that the pinch rollers are evenly spaced.

- Hold the sheet between the pinch rollers and grit rollers.



- If the spacing is not uniform, repeat all steps from the start.

13 Unlock the roll stopper

- Pull the roll stopper lever toward the front of the machine while pressing in.

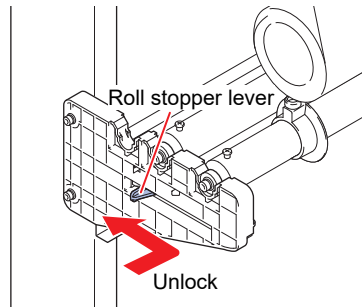
**14 Press ◀ or ▶ to select [ROLL].**

- Note about sheet detection ["Note about sheet detection"\(P. 45\)](#)
- ◀: If the roll sheet was loaded at the rear of the machine
- ▶: If the roll sheet was loaded at the front of the machine



- Pressing the [FEED] key displays a screen for selecting the number of pinch rollers before sheet detection. Select the number of pinch rollers before performing sheet detection.
- The number of pinch rollers set here takes precedence over the number of pinch rollers using the [SET UP] - [PINCH ROLL.] menu.

15 Press ▲▼ to select the number of pinch rollers to be used.

- If [ROLL. SELECT] is set to [ON], select the number of pinch rollers to be used. ["Setting the Number of Pinch Rollers to Use"\(P. 56\)](#)

16 Start sheet detection.

- If [DUMMY CUT] is set to [ON], a dummy cut is performed after sheet detection is complete. ["DUMMY CUT"\(P. 140\)](#)

17 Use [SHEET FEED] to pull out the length of sheet to be used. ["Sheet Feed"\(P. 120\)](#)

- Before using the roll sheet, make sure that there is sufficient sheet for the length to be used. Feeding the sheet reduces offset when cutting and also allows you to check in advance that the sheet is not askew.

Pinch Roller Position/Number and Clamp Settings**Moving the Pinch Rollers**

Move the pinch rollers by hand above the appropriate grit rollers to suit the width of the sheet to be loaded. Be sure to push the clamp lever to the rear to separate the pinch rollers from the grit rollers before moving them.

The range over which the pinch rollers can be moved is as follows. Use the pinch rollers positioned within the pinch roller marks.

For more information on the settings for the number of pinch rollers, refer to  ["Setting the Number of Pinch Rollers to Use"](#)(P. 56).

For more information on the sheet clamping pressure, refer to  ["Clamp"](#)(P. 28).

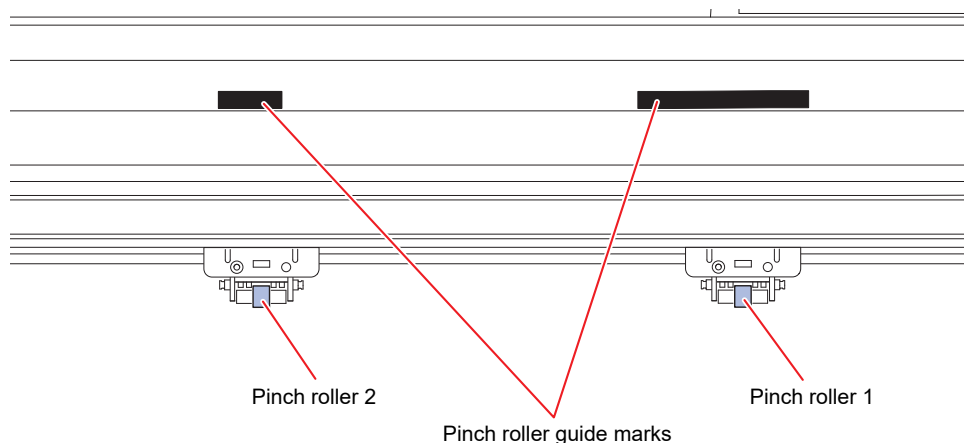

- Do not touch the rotating grit rollers. Otherwise there is a risk of skin abrasion or injury due to entrapment between the grit rollers and the platen.



- Do not position the pinch rollers away from or offset from the grit rollers. An error may occur and the sheet may not be able to be detected correctly if the pinch rollers are incorrectly positioned.

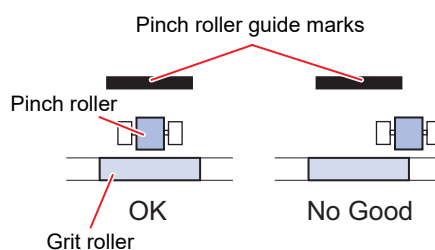

- When this machine is not in use, push the clamp lever to the rear to separate the pinch rollers from the grit rollers. Leaving the pinch rollers in the lowered position for an extended period of time may cause the pinch rollers to become deformed. Deformation of the pinch rollers may prevent the sheet from being fed correctly.





Setting the Number of Pinch Rollers to Use

Set the pressure and number used to hold the sheet based on the tool and sheet being used. Incorrect pinch roller pressure settings may result in sheet skew or leave pinch roller marks on the sheet.

For more information on the pinch roller positions, refer to  ["Pinch Rollers and Grit Rollers"](#)(P. 28).



- If [PINCH ROLLER] is set to [2] and [ROLL. SELECT] is set to [OFF], only two pinch rollers will be detected during sheet detection.
- When using wider sheets, the number of pinch rollers can be limited to avoid leaving roller marks on the sheet. This may reduce sheet drive accuracy, so either the cutting speed and up speed should be reduced sufficiently or [SHEET TYPE] should be set to [HEAVY] to restrict the drive speed.

- 1 Press the [FUNCTION] key in local mode.
- 2 Use   to select [SET UP], then press the [ENTER/HOLD] key.
- 3 Press   to select [PINCH ROLL.], then press the [ENTER/HOLD] key.

- 4 Press ▲▼ to select the number of pinch rollers to detect, then press the [ENTER/HOLD] key.
 - Number of pinch rollers: 2, 3
- 5 Press ▲▼ to select the [ROLL.SELECT] setting, then press the [ENTER/HOLD] key.
 - Settings: ON/OFF
 - Select [ON] to display the screen for selecting the number of pinch rollers to be used in sheet detection.
- 6 Press the [END] key several times to exit.

Setting the Clamp High/Low Mode

The sheet clamping pressure can be switched between high mode and low mode using the clamp pressure lever.

Select high or low mode to suit the sheet being used.

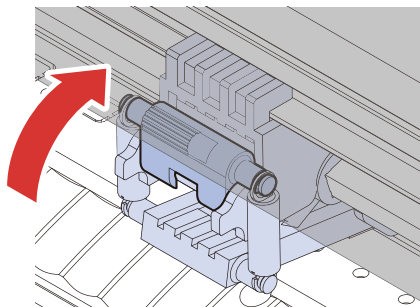

High mode: Raise clamp pressure lever

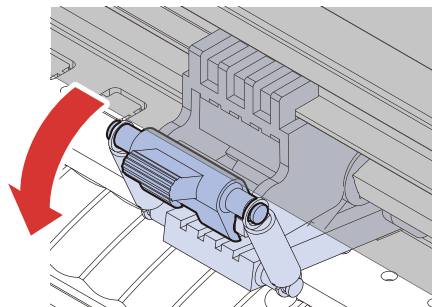

Low mode: Lower clamp pressure lever



- The clamps at each side must always be used set to high mode. The sheet may become skewed if the clamp mode is not correctly set.
- Set the clamp high/low mode once the pinch rollers have been positioned.

Clamp pressure lever	Use
High mode	Cutting PVC sheet When using heavy paper (at least 70 kg or 81 g/m ²)
Low mode	To reduce pinch roller marks



- When using low mode, the sheet may become skewed depending on the sheet type, feed rate, and sheet width.

● Enabling and Disabling the center clamp

Disabling the center clamp allows the middle pinch roller to be used in the raised position.

Raising the middle pinch roller provides the following benefits:

- No marks are left on the sheet.
- Prevents the sheet from lifting up.

Enable or disable the center clamp to suit usage.

Be sure to push back the clamp lever to raise the pinch rollers before enabling or disabling the center clamp.

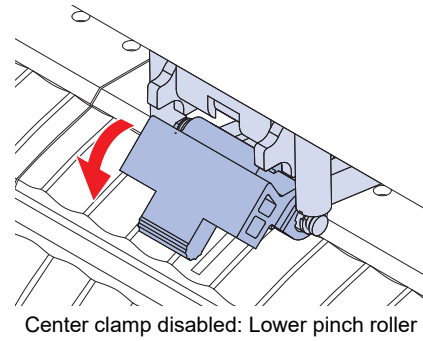
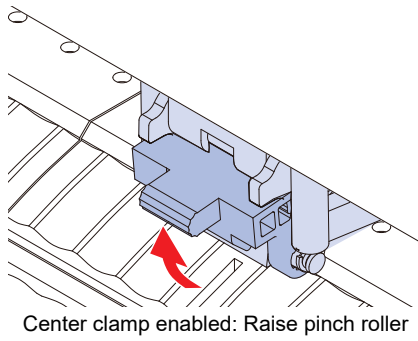

Three pinch rollers should always be used when using the maximum sheet width of the machine. Enable or disable the center clamp as necessary for the middle pinch roller.

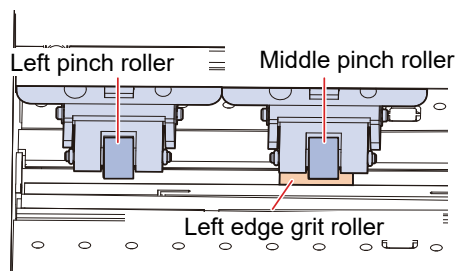

If only the right and middle pinch rollers are used, the maximum sheet width cannot be used, as the middle pinch roller cannot be moved as far as the left edge of the left grit roller, as shown in the following figure.



- When using three pinch rollers, set the number of pinch rollers to "3" regardless of whether the center clamps are enabled or disabled.

2.3 Installing Tools

This machine can be used with the following tools:

- Cutter (for cutting)
Used to cut the printed image on a sheet or to cut characters with the cutting sheet.
 ["Using the Cutter"\(P. 59\)](#)
- Pen (water-based ballpoint pen)
Used for test printing or to adjust register marks. This machine can be used with a ballpoint pen or cartridge refill.
 ["Using a Pen"\(P. 63\)](#)
- Creasing tool
Used for creasing coated card.
 ["Using the Creasing Tool"\(P. 67\)](#)

Using the Cutter

Installing the Cutter in the Cutter Holder

Be careful to keep the cutter from falling into a gap in this machine. We recommend replacing the cutter over the sheet to enable the cutter blade to be picked up easily if it falls.



- Avoid touching the cutter blade. Failure to do so may result in injury.
- Do not shake or swing the cutter holder. Doing so may cause the blade to come off.



- Avoid storing this product in locations accessible to children.



- When disposing of cutters, contact an industrial waste disposal operator or dispose in accordance with the local laws and regulations.

1 Insert the cutter into the cutter holder using tweezers.

- Check the orientation of the cutter before inserting it fully.

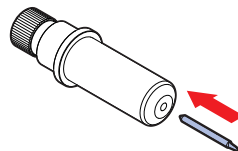

- For information on blade replacement, refer to  ["Cutter Replacement"\(P. 147\)](#).

Adjusting the Cutting Blade Protrusion Length

Adjust the cutting blade protrusion length (0.2 to 0.5 mm) to suit the cutter and sheet type being used.

- If the base paper is thicker than the label film: $(\text{label film thickness} + \text{base paper thickness})/2$

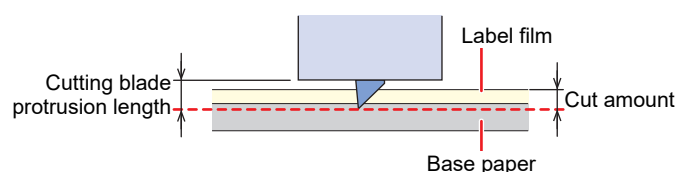

- If the base paper is thinner than the label film: As far as to cut into label film

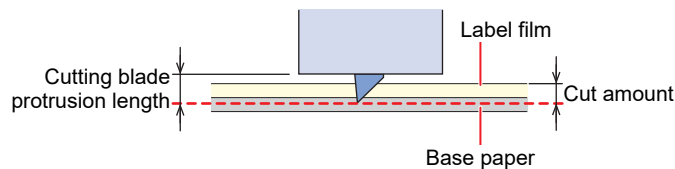

- The protrusion of the cutting blade can be adjusted accurately using the optional cutting blade adjuster tool.
Part number: OPT-C0066 "blade adjuster (for eccentric cutter)"

1 Turn the adjusting knob to adjust the protrusion of the cutting blade.

- Turn the adjusting knob in the direction indicated by the arrow in the picture to have the blade protrude. (0.5 mm per turn)

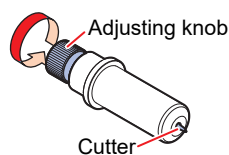

2 Check the cutting performance.

- Adjust the pressure so that it leaves slight marks on the base paper. A cutting blade that protrudes too far may damage the machine.
- If the base paper is thinner than the film, preventing accurate cutting quality from being achieved, better results may be obtained by altering the cutting blade protrusion length.

["Setting Tool Conditions"\(P. 69\)](#)

["Test Cutting"\(P. 72\)](#)



- When using the cutter holder included in the delivery, you can adjust the protrusion length while the cutter is attached to the tool holder. (0.5 mm per turn of the adjusting knob)

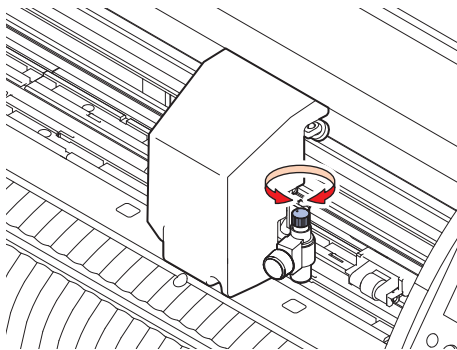

Installing the Cutter Holder

1 Turn the knob screw and loosen the holder presser.

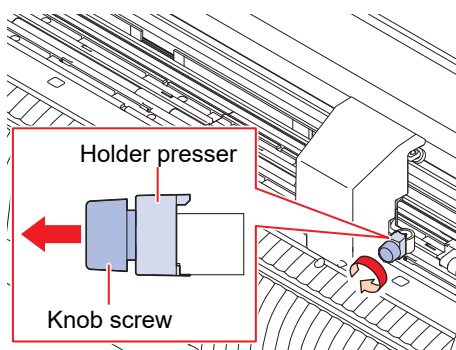

2 Insert the cutter holder into the tool holder.

- (1) Push the brim of the cutter holder against the tool holder.
- (2) Put the brim of the cutter holder into the tool holder.

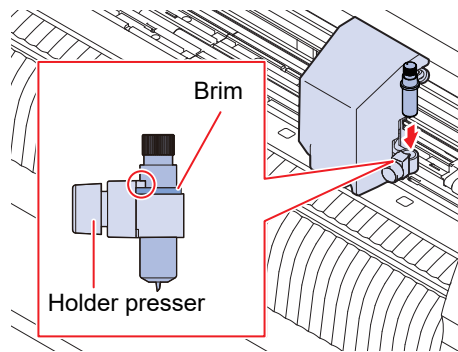

3 Secure the cutter holder.

- Turn the knob screw and fix the holder presser.
- Failure to secure firmly may result in lower quality.

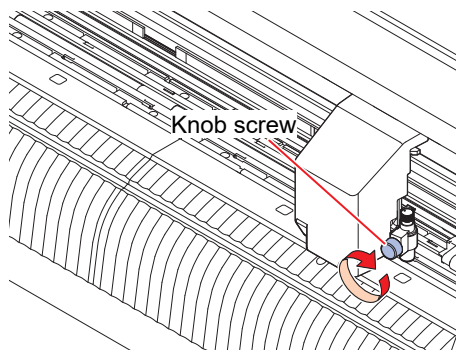

Installing the (Supply) Cutter in the Cutter Holder (SPA-0090)

1 Remove the cap from the cutter holder.

- Turn in the direction indicated by the arrow in the picture.

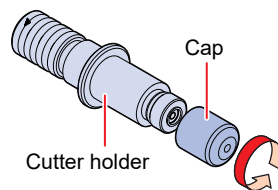

2 Insert the cutter into the cutter holder.

- Use tweezers to insert the cutter.

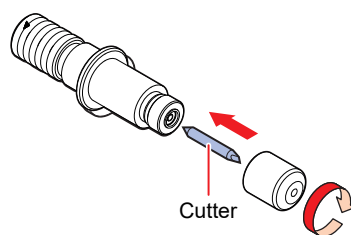

3 Fix the cap by turning in the direction indicated by the arrow in the picture.

Adjusting the Cutting Blade Protrusion Length

1 Turn the adjusting knob to adjust the protrusion of the cutting blade.

- Turn the adjusting knob in the direction indicated by the arrow in the picture to have the blade protrude. (0.5 mm per turn)

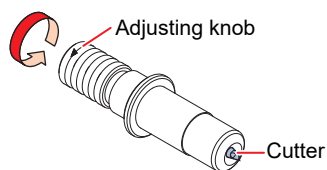

2 Check the cutting performance.

- Adjust the pressure so that it leaves slight marks on the base paper. A cutting blade that protrudes too far may damage the machine.

"Setting Tool Conditions"(P. 69)

"Test Cutting"(P. 72)



- The cutting blade protrusion length can be adjusted while the cutter holder is attached to the tool holder. (0.5 mm per turn of the adjusting knob)

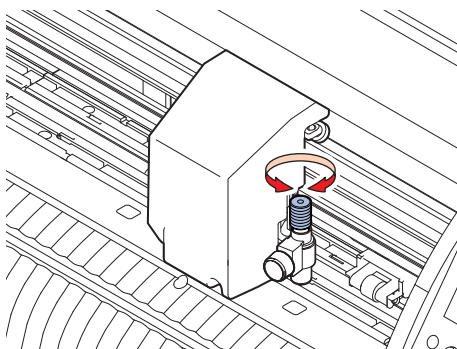

Installing the (Supply) Cutter in the Cutter Holder (SPA-0001)

1 Loosen the lock nut of the cutter holder and extract the adjusting knob.

- Turn in the direction indicated by the arrow in the picture.

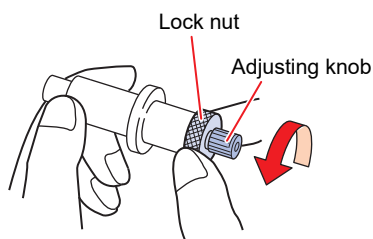

2 Insert the cutter into the adjusting knob.

- Use tweezers to insert the cutter.

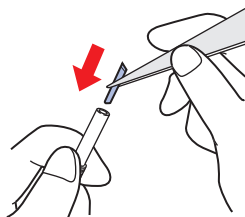

- 3** Fix the lock nut by turning in the direction indicated by the arrow in the picture.

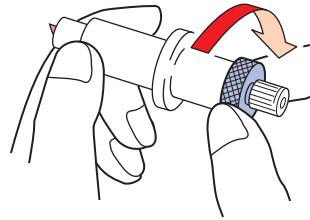

Adjusting the Cutting Blade Protrusion Length

- 1** Loosen the lock nut of the cutter holder.

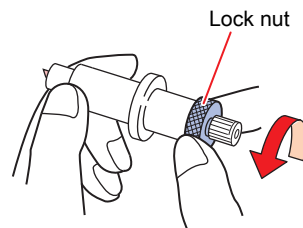

- 2** Turn the adjusting knob to adjust the protrusion of the cutting blade.

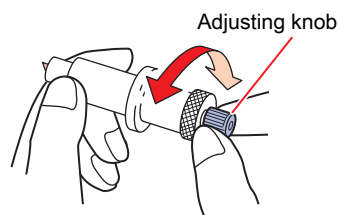

- 3** Fix the lock nut by turning in the direction indicated by the arrow in the picture.

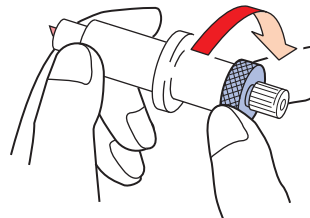

Using a Pen

Installing a Refill Cartridge for a Ballpoint Pen in the Pen Holder (Standard)

The image quality can vary depending on the type of refill cartridge.
Recommended: SXR-5 (Mitsubishi Pencil Co., Ltd.)

1 Remove the cap from the pen holder.

- Turn in the direction indicated by the arrow in the picture.

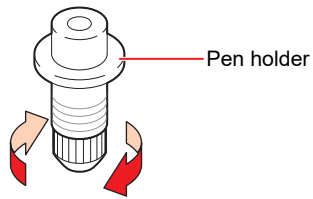

2 Insert a refill cartridge into the pen holder.

- Insert the refill cartridge until it hits the pen holder.

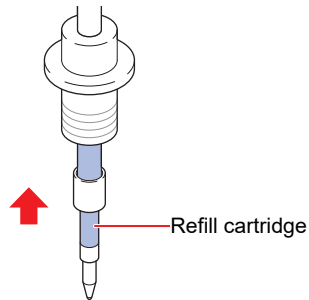

3 Insert the spring into the refill cartridge.

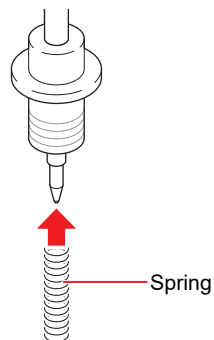

4 Fix the cap by turning in the direction indicated by the arrow in the picture.

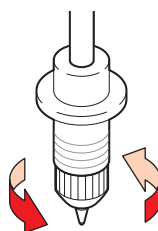

Installing a (Supply) Ballpoint Pen in the Pen Adapter (SPA-0169)

Use a ballpoint pen with a diameter of 8 to 9 mm. The ballpoint pen type may affect image quality.
Use a ballpoint pen supplied by Mimaki.

1 Put the cap on the pen adapter.

- The cap is used to adjust the height of the pen nib.

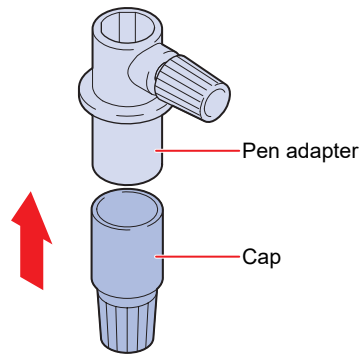

2 Insert the ballpoint pen into the pen adapter.

- Insert the pen nib until it hits the cap.

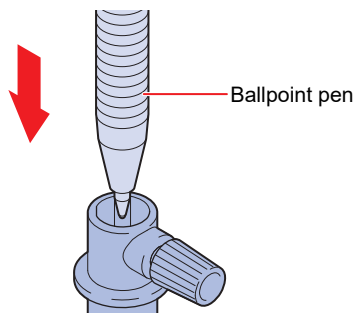

3 Fix the pen nib by turning the knob screw in the direction indicated by the arrow in the picture.

- Be careful to avoid overtightening the knob screw. Disregarding this precaution may damage or break the ballpoint pen.

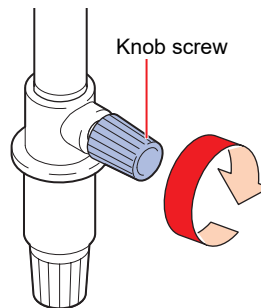

4 Remove the cap.

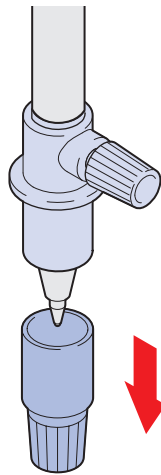

Installing a Pen

1 Turn the knob screw and loosen the holder presser.

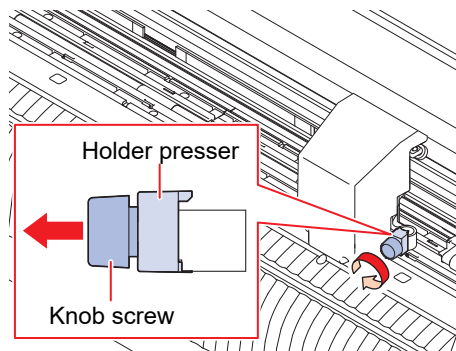

2 Insert the pen holder or pen adapter into the tool holder.

- (1) Push the brim of the pen holder or pen adapter against the tool holder.
 - Position the pen adapter so that the knob screw is easily accessible.
- (2) Push the brim of the pen holder or pen adapter against the holder presser.

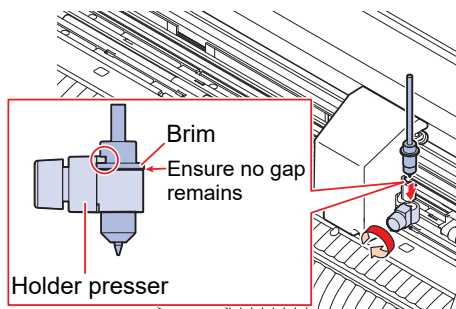

3 Secure the pen holder or pen adapter.

- Turn the knob screw and fix the holder presser.
- Failure to fix securely may result in lower quality.

Using the Creasing Tool

Be sure to use the optional sheet table and cutting sheet when creasing. ["Sheet Tables and Cutting Sheet"](#)(P. 152)

Installing the Creasing Tool

1 Turn the knob screw and loosen the holder presser.

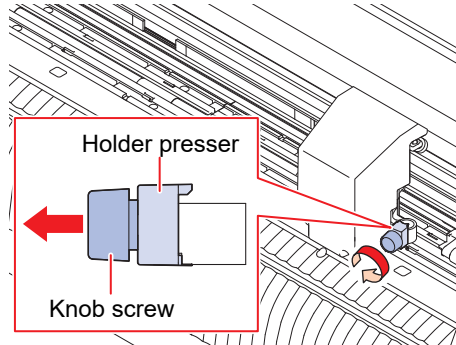

2 Insert the creasing tool into the tool holder.

- (1) Push the brim of the creasing tool flush with the tool holder.
- (2) Clamp the brim of the creasing tool.

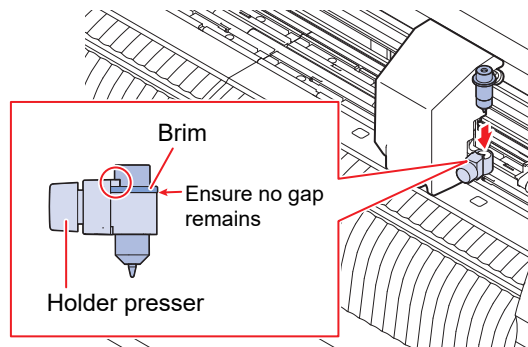

3 Secure the creasing tool in place.

- Turn the knob screw and fix the holder presser.
- Failure to secure firmly may result in lower quality.

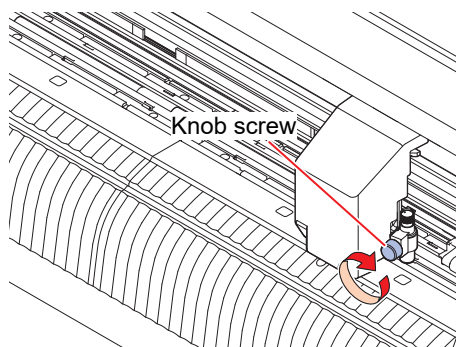

2.4 Selecting Tool Conditions

Before starting cutting (or printing), select the tool conditions to suit the sheet and tool being used.

- 1 Press the [TOOL] key on the local mode screen.
- 2 Press the [TOOL] key to select the required tool conditions.
 - Pressing the [TOOL] key toggles through the tool conditions as shown in the following figure.

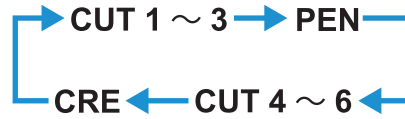

2.5 Setting Tool Conditions







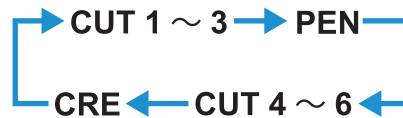

Set the cutting speed and pressure to match the type of sheet and tools used.

	Tool	Item			
		SPEED	PRESS	OFFSET	HALF
Cut	CUT1 to 6	Cutting speed	Cut pressure	Offset	Half cut
Print	PEN	Printing speed	Pen pressure	-	-
Crease ^{*1}	CRE	Speed	Pressure	-	-

*1. The creasing tool is optional.  "Using the Creasing Tool"(P. 67)

- 1 Press the [TOOL] key on the local mode screen.
- 2 Press the [TOOL] key to select the required tool conditions.
 - Pressing the [TOOL] key toggles through the tool conditions in the following sequence.



- 3 Press   to set the speed (SPEED).
 - Sets the speed for moving the tool when cutting or pen writing.
 - 1 to 10 cm/s (in 1 cm/s steps)
 - 15 to 70 cm/s (in 5 cm/s steps)
 - 73 cm/s
- 4 Press .
 - The cursor moves to PRESS.
- 5 Press   to set the pressure (PRESS).
 - Sets the pressure for cutting or pen writing.
 - Cutting/creasing: 10 g to 550 g
 - Pen: 10 to 150 g
 - 10 to 20 g (in 2 g steps)
 - 25 to 100 g (in 5 g steps)
 - 110 to 550 g (in 10 g steps)
- 6 Press . (for cutting only)
 - The cursor moves to OFFSET.
- 7 Press   to set the offset (OFFSET). (for cutting only)
 - Sets the distance from the center of the cutter holder to the cutting blade.
 - This is not displayed on the LCD if set to "0".
 - 0 (0.00) to 250 (2.50 mm) (in 0.05 mm steps)

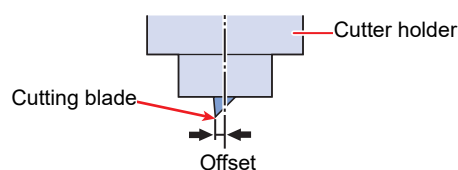

8 Press **▶**. (for cutting only)

- The cursor moves to the half cut setting (HALF).

9 Press **▲▼** to enable or disable half cut. (for cutting only)

- When enabled, a dotted line is cut without cutting out the base paper. Set the following items when this is enabled.

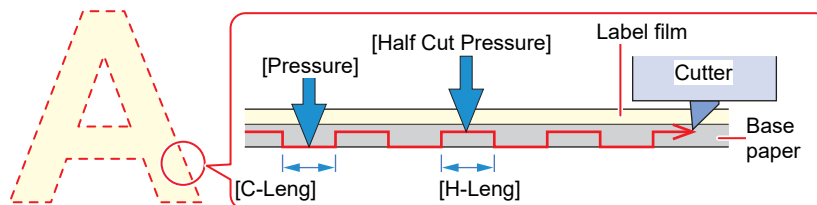

- Press **▶**.
 - The cursor moves to the half cut pressure setting (H-PRES).
- Press **▲▼** to set the half cut pressure.
 - Sets the pressure for the uncut portions when using half cut.
 - 0 to 300 g (in 5 g steps)
- Press **▶**.
 - The cursor moves to the uncut length setting (H-LENG).
- Press **▲▼** to set the uncut portion length.
 - Sets the uncut portion length when using half cut.
 - 0.1 to 5.0 mm (in 0.1 mm steps)
- Press **▶**.
 - The cursor moves to the cut length setting (C-LENG).
- Press **▲▼** to set the cut portion length.
 - Sets the cut portion length when using half cut.
 - 5 to 150 mm
5 to 20 mm (in 1 mm steps)
20 to 150 mm (in 5 mm steps)

10 Press the **[ENTER/HOLD]** key.

- The settings are entered and the system returns to local mode.
- The settings are retained even when the power is turned off.

● Settings List

Item	Message	Tool	Setting	Step size	Outline
Tool	TOOL	Cutter/ pen/ creasin g ^{*1}	CUT1 to 6/PEN/ CRE		<ul style="list-style-type: none"> • Press the key repeatedly to change the tool condition in the sequence shown below.
Speed	SPEED	Cutter/ pen/ creasin g ^{*1}	1 to 10 cm/s	1 cm/s	• Sets the speed for cutting, creasing, or pen writing.
			15 to 73 cm/s	5cm/s	

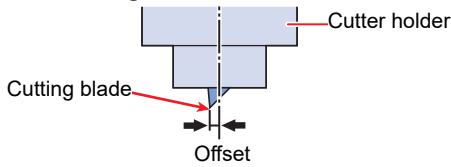
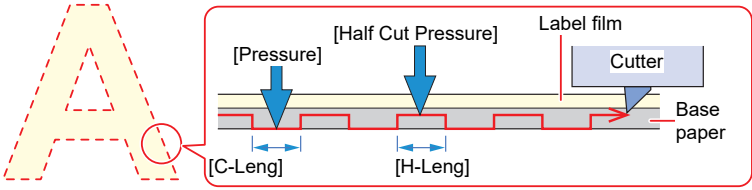
Item	Message	Tool	Setting	Step size	Outline
Pressure	PRESS	Cutter/creasing ^{*1}	10 to 550g	2 g (10 to 20 g) 5g (25 to 100g)	<ul style="list-style-type: none"> Sets the pressure for cutting, creasing, or pen writing. This setting is also required for half cuts.
		pen	10 to 150g	10g (110 to 550g)	
Offset	OFFSET	Cutter	0 (0.00) to 250 (2.50 mm)	0.05mm	<ul style="list-style-type: none"> Sets the length from the center of the cutter holder to the cutting blade. 
Half cut	HALF	Cutter	ON/OFF	<ul style="list-style-type: none"> Cuts across a dotted line without cutting out the base paper.  <ul style="list-style-type: none"> If HALF CUT is set to "ON", the three items listed below are displayed: Set the following three items and pressure in the Cutting Conditions menu: 	
Half cut pressure	H-PRES	Cutter	0 to 300 g	5g	<ul style="list-style-type: none"> Sets the pressure for the uncut portion.
Uncut length	H-LENG	Cutter	0.1 to 5.0mm	0.1mm	<ul style="list-style-type: none"> Sets the uncut length.
Cut length	C-LENG	Cutter	5 to 150mm	1 mm (5 mm to 20 mm) 5 mm (20 mm to 150 mm)	<ul style="list-style-type: none"> Sets the cut length.

*1. The creasing tool is optional.  ["Using the Creasing Tool"\(P. 67\)](#)

2.6 Test Cutting

Execute test cutting to confirm that the tool conditions are set appropriately.

Cutting can be improved by increasing the pressure, as the cutter blade grows dull with wear. This is only a temporary measure. We recommend replacing the cutter blade to maintain cutting quality.

1 Press the [FUNCTION] key on the local mode screen to select [SQUARE CUT].







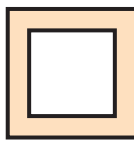

2 Press the [ENTER/HOLD] key.

- Test cutting starts.
- After cutting is complete, the head or sheet will automatically move to make it easier to check the result of the cut. (When the sheet is rear-set, the sheet is fed out; when it is front-set, the head moves horizontally.)

For the movement (feed), it is possible to switch ON (enable) or OFF (disable) from [SET UP] > [FEED OPTION] > [VIEW FEED].  ["Feed Settings \[FEED OPTION\]"](#)(P. 121)



3 Check the results of the test cut and change the cutting conditions by referring to the following table.

Test cut results	Cause	Solution
An uncut section was identified.	<ul style="list-style-type: none"> • The cutting blade lifted up due to the speed being too high. 	<ul style="list-style-type: none"> • Reduce the speed.  "Setting Tool Conditions"(P. 69) • Tighten the knob on the tool holder.  "Installing the Cutter Holder"(P. 60)
The base paper of the sheet is cut.	<ul style="list-style-type: none"> • The pressure is excessive. 	<ul style="list-style-type: none"> • Reduce the pressure.  "Setting Tool Conditions"(P. 69)
	<ul style="list-style-type: none"> • The cutting blade protrudes too far. 	<ul style="list-style-type: none"> • Reduce the protrusion of the cutting blade.  "Adjusting the Cutting Blade Protrusion Length"(P. 59)
The corners are rounded.	<ul style="list-style-type: none"> • The distance from the center of the cutter holder to the cutting blade is not set correctly. 	<ul style="list-style-type: none"> • Adjust the [OFFSET] value to suit the cutter used.  "Setting Tool Conditions"(P. 69)
The corners are turned up.	Two or more of the following apply:	
	<ul style="list-style-type: none"> • The cutting blade protrudes too far. 	<ul style="list-style-type: none"> • Reduce the protrusion of the cutting blade.  "Adjusting the Cutting Blade Protrusion Length"(P. 59)
	<ul style="list-style-type: none"> • The pressure is excessive. 	<ul style="list-style-type: none"> • Reduce the pressure.  "Setting Tool Conditions"(P. 69)
	<ul style="list-style-type: none"> • The [ADJ-PRS OFS] value is too large. 	<ul style="list-style-type: none"> • Reduce the [ADJ-PRS OFS] value.  "ADJ-PRS OFFSET"(P. 140)



4 When the [BACK FEED:ENTER] displayed, press the [ENTER/HOLD] key.

- The head moves to the position before the movement and the system returns to local mode.

2.7 Cut the data.

Cutting software is required to cut data. For more information on cutting software, refer to  "Installing Cutting Software and Plotter Driver"(P. 20).

Check beforehand

- Were the pinch roller positions adjusted?  "Pinch Rollers and Grit Rollers"(P. 28)
- Is the sheet loaded?  "Loading a Sheet"(P. 44)
- Has the number of pinch rollers been set?  "Setting the Number of Pinch Rollers to Use"(P. 56)

Setting the Origin

Set the cutting start point. The origin set here will be the origin of the cutting software you are using. When cutting the same data again, change the origin. If not, cutting starts at the same position.

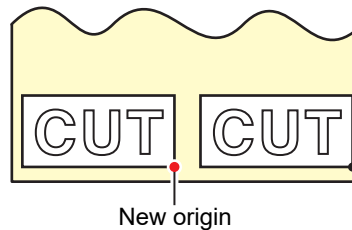

1 Press in local mode to move the origin to the desired position.

- Pressing the [TOOL] key raises and lowers the tool. Move to the correct position while checking the position where the tool was lowered.

2 Press the [ENTER/HOLD] key.

- The origin is set.
- The available cutting area is displayed, and the tool conditions are then displayed.



- Note that if the sheet sensor is disabled or if the carriage is above the sheet sensor and the front edge of the sheet has not been detected, the sheet may fall.

Starting Cutting

1 Press the [REMOTE] key.

- The machine switches to remote mode.

2 Send the cutting data from the host computer.

- Cutting starts.
- The remaining amount of data is displayed on the display.



- For more information, refer to the operation manual of the cutting software you are using.



- If the sheet moves out of place during cutting, immediately turn off the power. Continuing to cut while the sheet is not in place may damage the machine.

Pausing Cutting

1 Press the [REMOTE] key while cutting is in progress.

- Cutting is paused.
- If data is being sent from a PC, data transmission is paused at the PC.

2 Press the [REMOTE] key.

- Cutting resumes.



- An error message will appear if operation functions or operations affecting the command coordinate system are performed while cutting is paused. If an error message appears, either quit cutting or use data clear to abort cutting.  "Aborting Cutting (Data Clear)"(P. 74)

Aborting Cutting (Data Clear)



- If data is not cleared, data already received will be cut on returning to remote mode.
- If data is cleared and data is received after returning to remote mode, new data will be cut.
- Do not clear data while data is in the process of being sent.

1 Check to confirm that data is not currently being received.

- Check, at the top right of the screen, that the amount of data received is not increasing.



- Do not clear data while data is being received.

2 Press the [REMOTE] key.

- Cutting is paused.

3 Press the [FUNCTION] key.

4 Press to select [DATA CLEAR], then press the [ENTER/HOLD] key.

- The data is cleared.



- The data received remains within the receiving buffer even after using data clear. Repeated cutting is possible using the multiple sheet cutting function.

Retracting the Carriage

The carriage remains over the platen after cutting has ended. To check the cutting results or to load a new sheet, push the clamp lever to the rear, then move the carriage away from the platen by hand.

2.8 Separating Sheets (Manual Cutting)

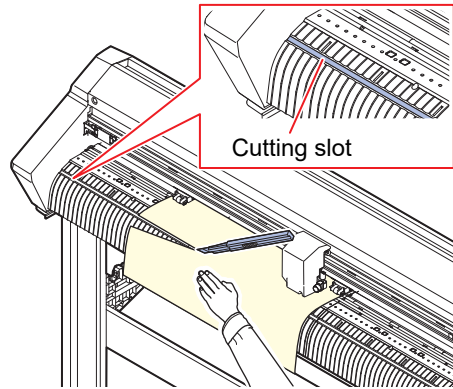

- 1 Press down on the sheet with your hand.**
 - Press down firmly to prevent the sheet lifting up while cutting.
- 2 Cut the sheet.**
 - Cut the sheet along the cutting slot on the platen using a retractable knife.

Chapter 3 Cutting Data with Register Marks



This chapter

Describes the register mark creation conditions and basic information.

Process for Cutting Data with Register Marks	78	Detect register marks	89
Creating Register Marks	80	Checking Sheet Tilt Using the LED Pointer	89
Register Marks	80	Detecting Register Marks Using Full-	
Register Mark Size	81	Automatic Detection	90
Spacing Between Register Marks	82	Detecting Register Marks Using Semi-	
Reading Range of Register Marks	82	Automatic Detection	92
No-Plotting Areas Around Register Marks	84	Detecting Register Marks Automatically After	
Register Mark Detection Precautions	84	Sheet Detection	95
Setting Register Mark Detection Conditions	85	ID Cut Process	97
Notes on Register Mark Detection Setting			
Items	85		

3.1 Process for Cutting Data with Register Marks

Printing images to be used as labels with "register marks" allows sheets to be cut by detecting the register mark positions.

1. Create data with register marks.

 ["Creating Register Marks"\(P. 80\)](#)

This machine can detect the following two types of register marks:

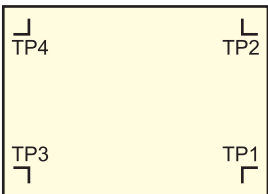
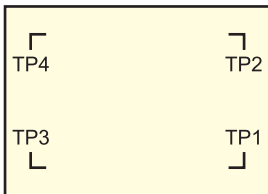
Mark shape	
Type 1	Type 2
	

2. Print printing data with register marks.

3. Prepare for cutting.

 ["Cutting Process"\(P. 42\)](#) (Steps 1 to 8)

4. Set register mark detection conditions.

 ["Setting Register Mark Detection Conditions"\(P. 85\)](#)

5. Detect register marks.

 ["Detect register marks."\(P. 89\)](#)

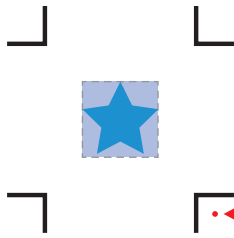
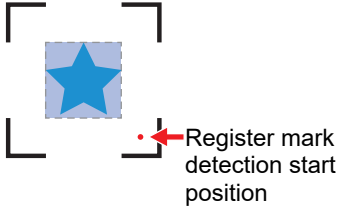
Mark shape	
Type 1	Type 2
 <p>Register mark detection start position</p>	 <p>Register mark detection start position</p>

6. Cut the data.

 "Cut the data."(P. 73)

7. Cut the sheet.

 "Separating Sheets (Manual Cutting)"(P. 75)

3.2 Creating Register Marks

Printing image data with "register marks" can increase cutting accuracy and quality. There are some limitations to register marks. Read the following thoroughly before creating register marks.

Trimming register marks cannot be used with this machine.

Register Marks

The following two types of register marks can be used with this machine:

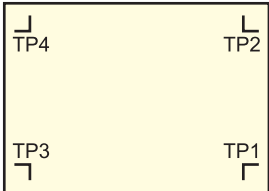
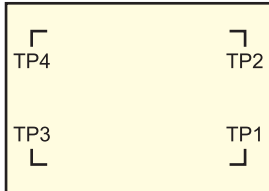
Mark shape	
Type 1	Type 2
	



- Use mark 4 (TP4) to perform trapezoidal corrections. Mark 4 can be skipped, but doing so will reduce cutting accuracy.
Trapezoidal correction: Corrects any difference in feed rate between left and right edges of the sheet.

Sheet and Register Mark Color

We recommend using a white sheet and black register marks. The machine may fail to detect register marks in other colors.

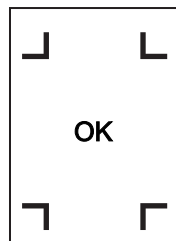

Blurred Register Marks

Ensure that printed register marks are not blurred. If the register marks are blurred, the mark origins may be incorrectly identified, or the machine may fail to detect the register marks.



OK



No Good

Register Mark Size

The recommended register mark size (A) is within the range of A4 size (210 mm x 297 mm) to A3 size (297 mm x 420 mm). This reduces wasted margins and enables designs to be laid out efficiently. If the dimensions exceed A3, the machine may fail to detect register marks due to sheet feeding problems (e.g., sheet meandering).

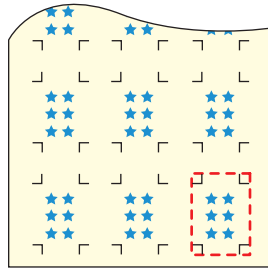

Standards for Register Mark Length and Line Width

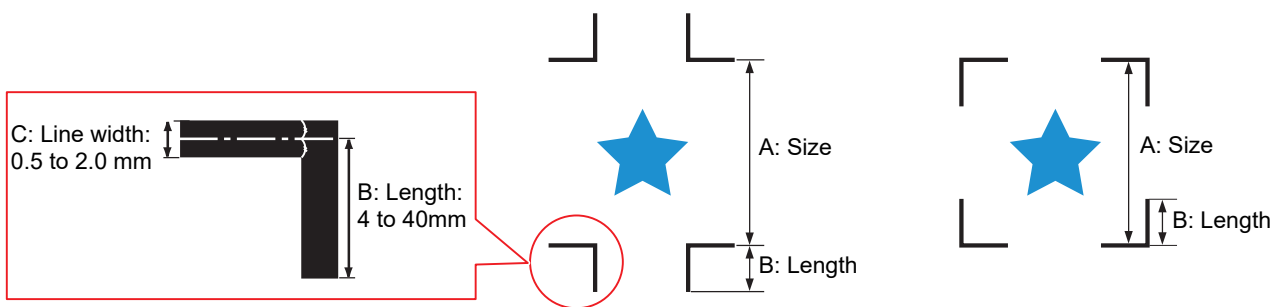

The recommended register mark length and line width are as shown below. The machine may fail to detect register marks that lie outside the recommended range.

As a guide, the register mark length should be at least ten times the line width.

Register mark size (A)	Register mark length (B)	Register mark line width (C)
200 mm or less	4 mm or more	0.5 mm
201 to 500 mm	8 mm or more	
501 to 1000 mm	15 mm or more	1.0 mm
1,001 to 2000 mm	25 mm or more	
2,001 mm or more	35 to 40 mm	

- If the "Fill around the register mark" function of the Mimaki cutting software is enabled, the register mark length (B) should be 10 mm or more.

When Printing Register Marks Continuously

The register mark length (B) should be 8 mm or more. The machine may fail to detect register marks less than 8 mm if it reads them continuously.

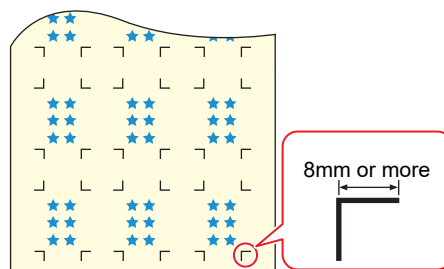

Spacing Between Register Marks

The spacing between register marks (D) is as shown below. B is the length of the Register mark.  "When Printing Register Marks Continuously"(P. 81)

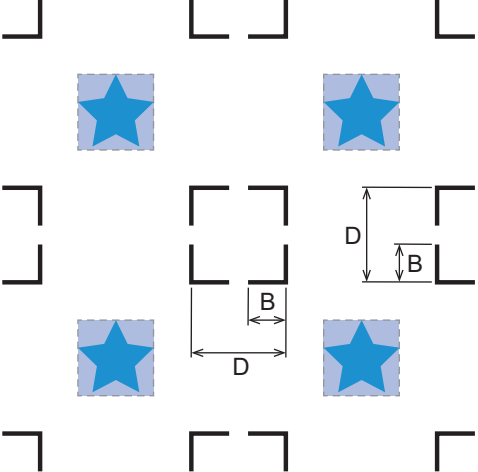
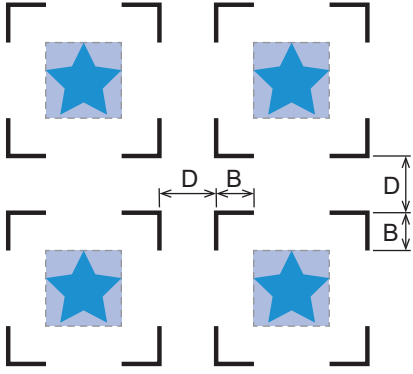
Mark shape	
Type 1	Type 2
Register mark spacing (D): Register mark length (B) x 2 to 1,000 mm 	Register mark spacing (D): 8 to 1,000 mm 

● Mark Origin Mis-detection Example

- If the spacing between register marks (D) is narrow, as shown in the figure below, the machine may fail to detect them.

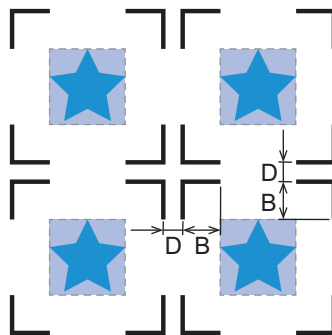

Reading Range of Register Marks

This machine can detect register marks in the range shown in the following figure. If the margin is small, the edge of the sheet may be incorrectly identified as a register mark.

If expand is disabled, set the distance between the register mark and the inside of the pinch roller to at least 5 mm for Type 1 register marks and at least the length of the register marks for Type 2 marks.

When using long sheets, the sheet may meander, which reduces the distance between the register marks and inside of the pinch roller. Larger margins are recommended when using long sheets.

- Expand:  "Expanding the Cutting Area [EXPANDS]"(P. 108)

● Register mark shape: Type 1

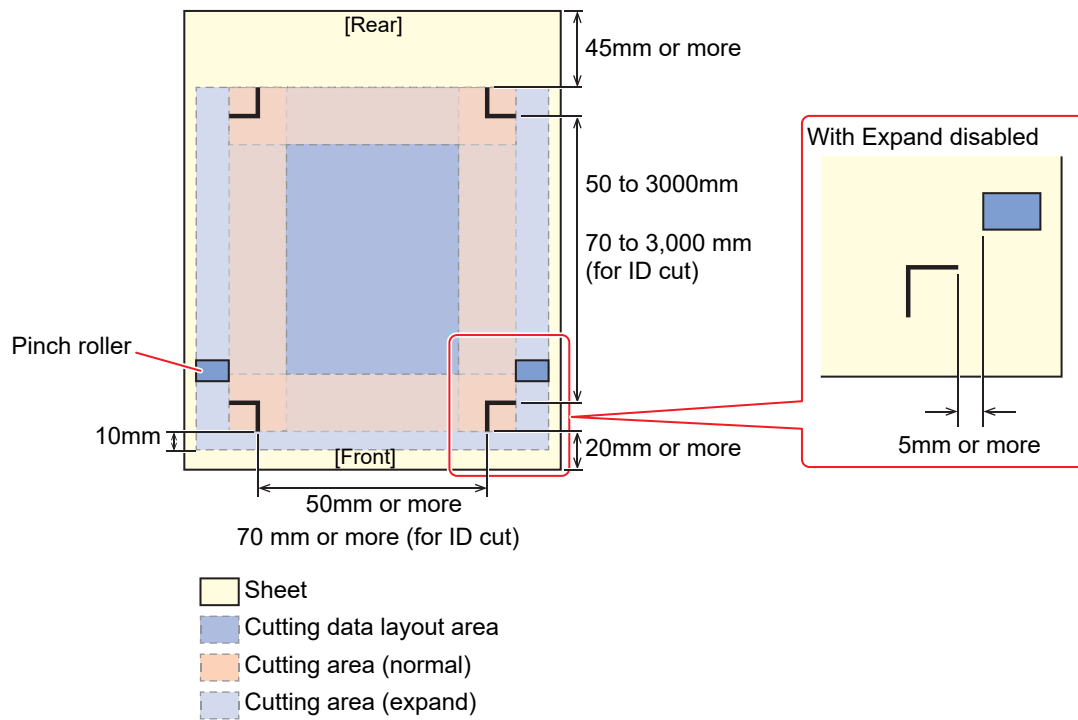

● Register mark shape: Type 2

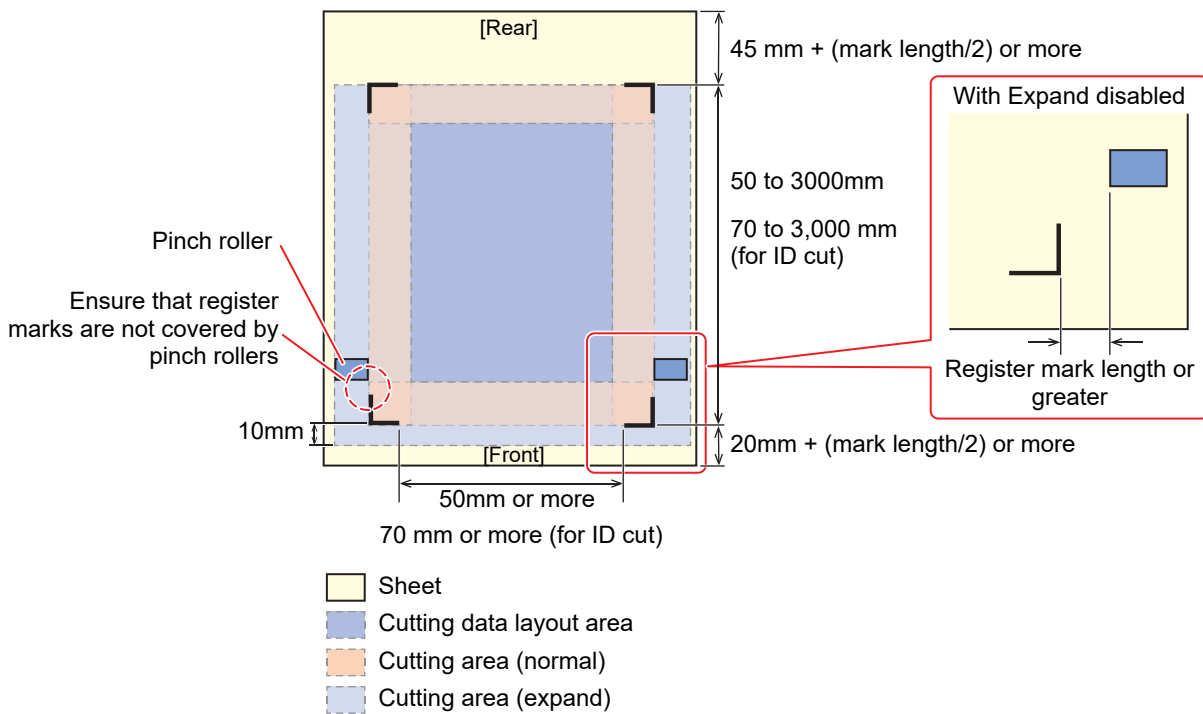

This machine can detect register marks in the range shown in the above figure.

● ID Cut

For more information on ID cut, refer to "ID Cut Process"(P. 97) and the ID Cut Guide. The ID Cut Guide can be downloaded from the official Mimaki website. (<https://mimaki.com/download/>)

No-Plotting Areas Around Register Marks

Do not plot data around register marks. The mark origins may be identified incorrectly, or the machine may fail to detect the register marks.

Mark shape	
Type 1	Type 2
<p> : No-Plotting areas : Layout area </p>	<p> : No-Plotting areas : Layout area </p>

● Mark Origin Mis-detection Example

- If register marks are plotted in the no-plotting area as shown in the figure below, the line may be incorrectly identified as a register mark.

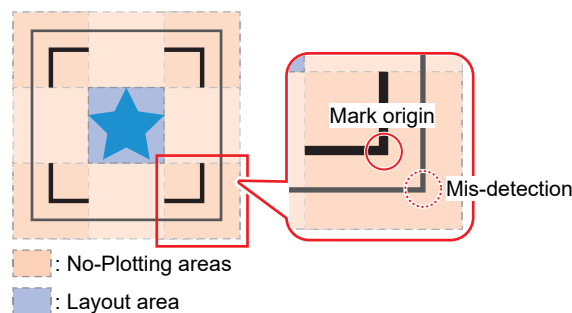

Register Mark Detection Precautions

- To ensure the distance between register marks is the same as the cutting length, enter the distance between printed register marks when they are detected. [☞ "Scale compensation setting \[DIST.REVI.\]"\(P. 86\)](#)
In this case, the distance correction is disabled, and register mark spacing scale correction takes precedence.
Subsequently altering the distance correction function value disables the register mark spacing scale correction.
- The sheet tilt correction, register mark spacing scale correction, and origin position will be cleared if the clamp lever is pushed to the rear and the sheet removed.
- The origin is set at TP1 (position at center of corner lines) when a register mark is detected.
- Using the jog keys to set the origin to another position enables that origin.
- Position the register marks to form a rectangle when the four points are linked.
Cutting offset may result if the marks are arranged unevenly.
- If the rotation function was set, this will be automatically disabled.

3.3 Setting Register Mark Detection Conditions

- 1 Press the [FUNCTION] key in local mode.
- 2 Press the ▲▼ keys to select [SET UP], then press the [ENTER/HOLD] key.
 - [MARK DETECT] appears on the screen.
- 3 Press the [ENTER/HOLD] key.
 - [MARKDETECT: OFF] appears on the screen.
- 4 Press the ▲▼ keys to select the number of register marks to be detected, then press the [ENTER/HOLD] key.
 - Settings: OFF, 1pt, 1ptA, 2ptB, 3pt, 4pt
 - Register mark detection is not performed when "OFF" is selected. Press the [END] key several times to exit.
- 5 Pressing the [ENTER/HOLD] key toggles through the following items on the display. ▲▼ Use the keys to select the setting, then press the [ENTER/HOLD] key.
 - Scale compensation/Register mark size/Offset A/Offset B/Form of registration mark/Number of continuous cutting in direction A/Number of continuous cutting in direction B/High-speed limit/Skew check/Detect mode/Sensor sensitivity/Filled in register marks/Data ID code
 - 🔗 ["Notes on Register Mark Detection Setting Items"\(P. 85\)](#)
- 6 Press the [END] key several times to exit.

Notes on Register Mark Detection Setting Items

● Register mark detection points setting [MARK DETECT]

Increasing the number of detection points increases the cutting accuracy.



- When cutting using FineCut/Coat9, set to "1pt". The number of register mark detection points set in FineCut/Coat9 takes precedence.

Setting	Details
OFF	Cuts without detecting register marks. Set this when cutting normal sheets.
1pt	Detects register mark 1 and only sets the origin.
2ptA	Detects register marks 1 and 2, and performs tilt correction and scale compensation in the sheet feed direction.
2ptB	Detects register marks 1 and 3, and performs tilt correction and scale compensation in the width direction.
3pt	Detects register marks 1 to 3, and performs tilt correction and scale compensation in the sheet feed and width directions.
4pt	Detects register marks 1 to 4, and performs tilt correction and three-point scale compensation in addition to trapezoidal correction.

● Scale compensation setting [DIST.REVI.]



- When cutting using FineCut/Coat9, set [DIST.REVI.] to [OFF].

Setting	Details
OFF	Scale compensation is not input for register mark detection.
BEFORE	Scale compensation and trapezoidal correction ^{*1} values are entered before register mark detection. (☞ "Detect register marks."(P. 89)) The distance between register marks is entered in advance, allowing high-speed movement between register marks during register mark detection.
AFTER	Scale compensation and trapezoidal correction ^{*1} values are entered after register mark detection. (☞ "Detect register marks."(P. 89)) Settings can be completed more quickly, as the distance between register marks is known due to register mark detection. Specifying afterward allows setting in a shorter time.

*1. Differences in grit roller diameter may result in differences in feed rate between left and right sides of the sheet. Trapezoidal correction is used to correct errors resulting from such differences in feed rate.

● Register mark size setting [SIZE]

Setting	Details
4 to 40mm	<p>Sets the length of one side of the register mark.</p> <p>If the lengths of the horizontal and vertical lines of the printed register mark differ, this sets the shorter line length.</p> <div style="text-align: center;"> </div>

● Offset A and Offset B settings [OffsetA/OffsetB]

Setting	Details
-40 to 40mm	<p>The origin is normally positioned as shown in the following figures.</p> <p>However, the cutting position may shift in the same direction, depending on the application used and the sheet being cut. If this occurs, alter the position of the origin.</p> <div style="text-align: center;"> </div> <p>[ERR37 MARK ORG] will appear if the origin position lies outside the effective cutting range. If this occurs, set so that the register mark position is toward the center of the sheet.</p>

● Register mark shape setting [FORM]

Setting	Details
Type 1	Select one of two types of register mark shape.
Type 2	

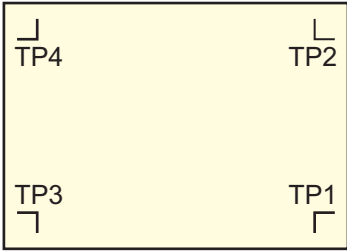
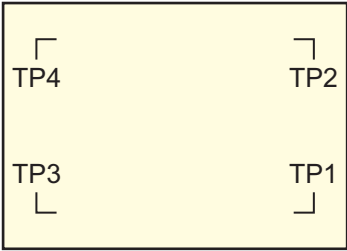
Setting	Details
	<div style="display: flex; justify-content: space-around;"> <div style="text-align: center;"> <p>Register mark: Type 1</p>  </div> <div style="text-align: center;"> <p>Register mark: Type 2</p>  </div> </div>

● COPIES A (UP) and COPIES B (LEFT) settings [COPIES A (↑) and COPIES B (←)]

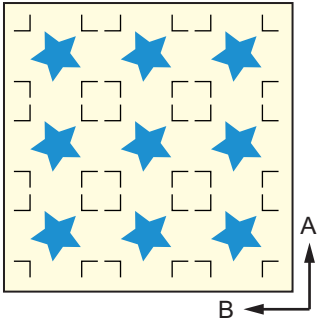
Setting	Details
1 to 9999 (COPIES A)	This is enabled when the same pattern is printed in multiple with uniform spacing. The specified number of patterns is cut while continuously reading the register marks based on the first data.
1 to 99 (COPIES B)	Set the number in the A direction for [COPIES A] and the number in the B direction for [COPIES B]. When leaf sheet (cut sheet) is used, the [COPIES A] value is used for the number of copies. If the number of copies is specified in the application software, such as FineCut/Coat9, set the number of copies to [1].
	

● Speed limit setting [SPD LIMIT]

Setting	Details
0 to 60 cm/s	<p>Sets the speed limit for high-speed movement for continuous copies.</p> <p>Depending on the sheet type, the sheet may slip during high-speed movement, preventing register marks from being correctly detected. Limit the movement speed in such cases.</p> <p>Set to [0] if the speed is not to be limited.</p>

● Skew check setting [SKEW CHECK]

Setting	Details
OFF, 1 to 99 mm	<p>Sets the permissible sheet offset for continuous copying.</p> <p>With continuous copying using roll sheets, gradual shifting may occur due to sheet tilt.</p> <p>Cutting is paused if the B axis coordinate for register mark 1 exceeds the setting. Correct the sheet skew, then press the [ENTER/HOLD] key. The machine then waits for register mark detection.</p> <p>Use the jog keys to move the LED pointer illuminated point to the position shown in the following figures, then press the [ENTER/HOLD] key. Registration mark</p>

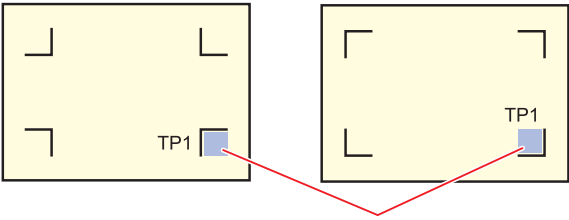
Setting	Details
	reading resumes.  <p style="text-align: center;">Register mark detection start position</p> Set to [OFF] if checking is not required.

● Detection mode setting [DETECT MODE]

Setting	Details
High Speed (FAST)	Register mark lines are scanned bi-directionally to determine the position. Detection time is reduced, but accuracy is also reduced.
Precision (PREC)	Register mark lines are scanned bi-directionally and then re-scanned from a distance before and after the lines to match the speed for response and determine the position accurately. Detection time increases, but accuracy also increases.

● Sensor sensitivity setting [SENSOR LEVEL]

Setting	Details
1 to 7	Check the sensitivity of the register mark sensor. Normally, set this to "4". <ul style="list-style-type: none"> • If it cannot detect the register marks: Increase sensitivity. • If it mis-detects the register marks: Decrease sensitivity.

● Filled-in register mark setting [MARK FILL UP]

Setting	Details
ON, OFF	Set to [ON] when detecting register marks printed using the FineCut/Coat9 "Fill around the register mark" function. If the "Fill around the register mark" function is used, the register marks should be at least 10 mm in size.

● DATA ID CODE

Setting	Details
ON, OFF	Set to [ON] when detecting register marks with an ID printed using the FineCut/Coat9 "ID Cut" function.  "ID Cut Process"(P. 97)

● Setting the media number [MEDIA]

Setting	Details
MEDIA 1 to MEDIA 8	When you perform sensor offset adjustment, select the media number to register the adjustment value. Generally "MEDIA 1" will remain unchanged. The register mark detection position may shift when a specific media is used. In this case, assign a sensor offset adjustment value dedicated to a specific media.  "Aligning the Register Mark Sensor Position"(P. 164)

3.4 Detect register marks.

Register marks can be detected using either full-automatic or semi-automatic detection. Detect using semi-automatic detection in cases where TP1 is not at the bottom right of the sheet or when using FineCut/Coat9.



- Curled sheets must be uncurled first.
- If using cutting software that does not include register mark functions, use a sheet free of any images or marks between TP1 and TP2 (A) and between TP1 and TP3 (B).

Checking Sheet Tilt Using the LED Pointer

Pushing the clamp lever to the rear illuminates the LED pointer. The carriage can also be moved left or right by hand.

Using the track of the LED pointer, push the clamp lever to the rear and move the carriage between TP1 and TP3 to check for sheet tilt. Adjust the sheet tilt using the track.



- The LED pointer automatically turns off if not used for more than five minutes.

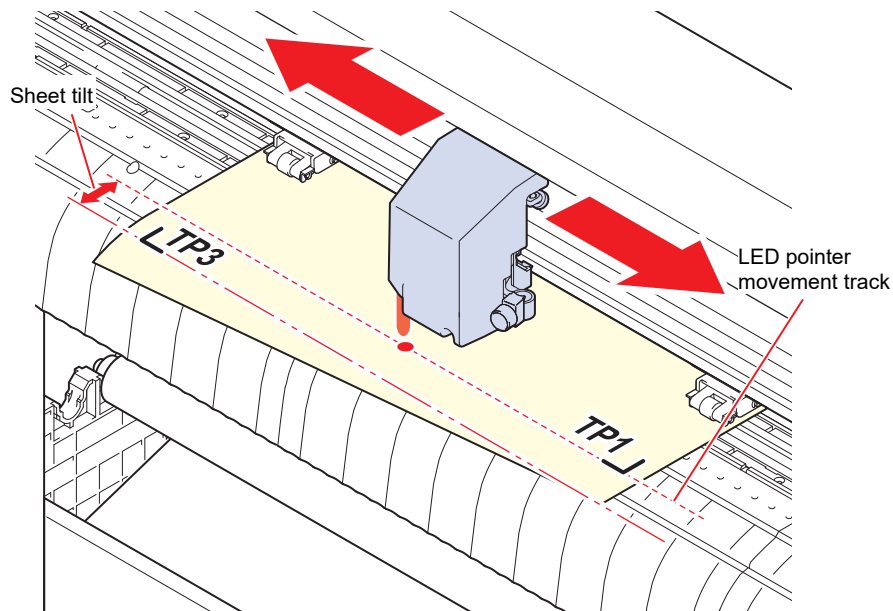

Detecting Register Marks Using Full-Automatic Detection

The distance between register marks detected by the plotter is adjusted against the distance between the register marks printed on the sheet.

First, measure the distances (A and B) between the register marks in the data.

Measure between the register mark center points.

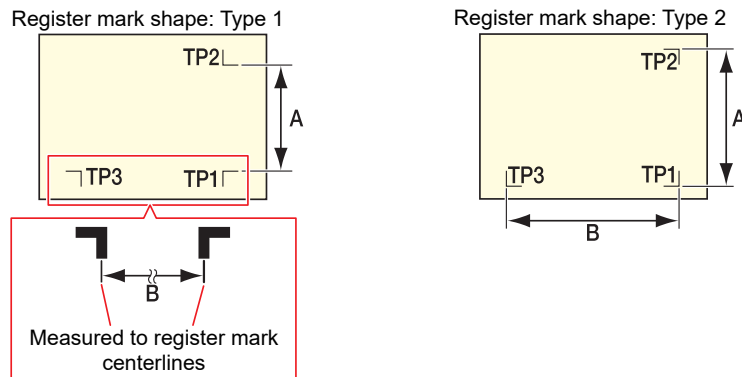

● Detection procedure using front specification

The sheet must be loaded from the rear.

1 Measure the distances A and B on the data to be output.

2 Position TP1 as shown in the following figure.

- Use ["Detecting Register Marks Using Semi-Automatic Detection"\(P. 92\)](#) if TP1 is not positioned as shown in the following figure.

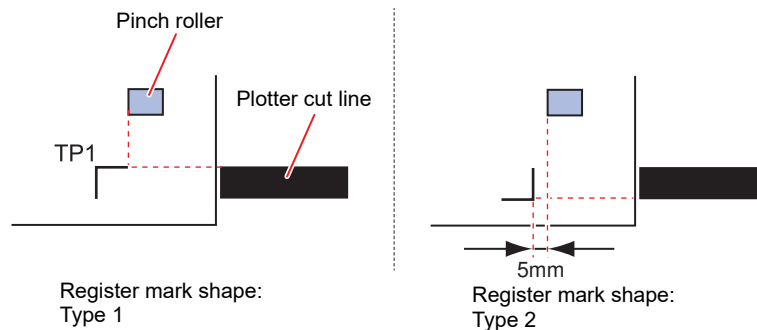

3 Pull the clamp lever toward you while ensuring that the sheet does not move.

- The sheet is held by the pinch rollers.

4 Press the [ENTER/HOLD] key.

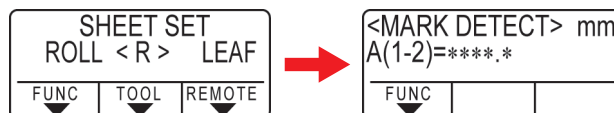

- If [ROLL. SELECT] is set to [ON], select the number of pinch rollers to be used. ["Setting the Number of Pinch Rollers to Use"\(P. 56\)](#)

5 Set using ▲▼.

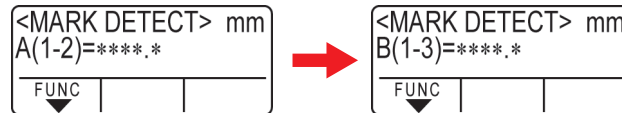

- Press the [ENTER/HOLD] key to proceed to the next scale compensation setting.
- If [MARK DETECT] is set to [2ptA], the screen for entering distance B does not appear.
- If [MARK DETECT] is set to [2ptB], the screen for entering distance A does not appear.
- If [MARK DETECT] is set to [1pt], the origin is displayed, and the scale compensation screen does not appear. (Step 7)

6 Press the [ENTER/HOLD] key after setting.

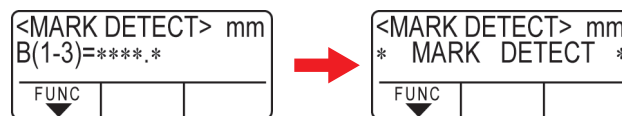

- Register mark detection starts.
- [ERROR C36 MARKdetect] appears on the display if no register marks can be detected. If this occurs, reload the sheet.



- For more information on the number of register marks detected, refer to "Register mark detection points setting" (☞ ["Register mark detection points setting \[MARK DETECT\]"](#)(P. 85)).

7 Display the origin.

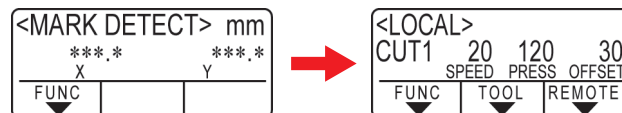

- The available cutting area is displayed following register mark detection, before switching to local mode.

● Detection procedure using rear specification

The sheet must be loaded from the rear.



- 1 Perform steps 1 to 3 of "Detection procedure using front specification" (☞ ["Detection procedure using front specification"](#)(P. 90)).

2 Press the [ENTER/HOLD] key.

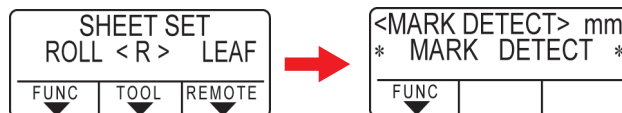
- Only the sheet width is detected, after which register mark detection starts.
- If [ROLL. SELECT] is set to [ON], select the number of pinch rollers to be used.  "Setting the Number of Pinch Rollers to Use"(P. 56)
- [ERROR C36 MARKdetect] appears on the display if no register marks can be detected. If this occurs, reload the sheet.



3 Once the register marks have been detected, set using the scale compensation setting screen.

- The following example shows the procedure for four-point detection.
- Set using   if the detected register mark distances differ from the measured values.
- Press the [ENTER/HOLD] key to proceed to the next scale compensation setting.
- If [DIST.REVI.] is set to [OFF], the screen for setting scale compensation does not appear.
- If [MARK DETECT] is set to [2ptA], the screen for entering distance B does not appear.
- If [MARK DETECT] is set to [2ptB], the screen for entering distance A does not appear.
- If [MARK DETECT] is set to [1pt], the scale compensation screen does not appear. Proceed to Step 4, and set the origin.

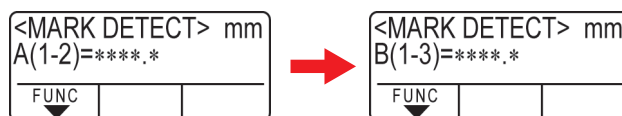

4 Press the [ENTER/HOLD] key after setting.

- Set the origin.
- The available cutting area is displayed before switching to local mode.

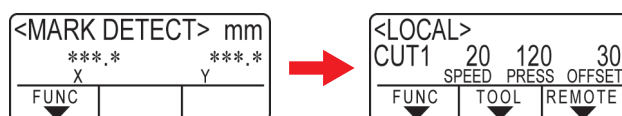

Detecting Register Marks Using Semi-Automatic Detection

If TP1 cannot be placed at the full-automatic register mark detection position or if register marks cannot be detected using full-automatic detection, detect register marks manually.

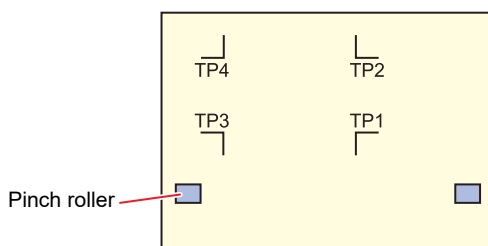

Detection procedure using front specification**1 Load the sheet, then pull the clamp lever toward you.**

- The sheet is held by the pinch rollers.

2 Press ◀▶ to start sheet detection. (Load from rear)

- If [ROLL. SELECT] is set to [ON], select the number of pinch rollers to be used. 🗨️ "Setting the Number of Pinch Rollers to Use"(P. 56)
- Once the sheet has been detected, the display indicates that the machine is waiting for register mark detection.

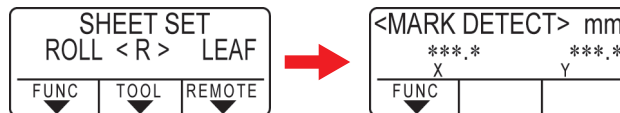

- When loading from the front, the positions of TP1 to TP4 will be reversed, as shown in the figure.

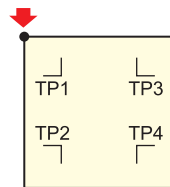
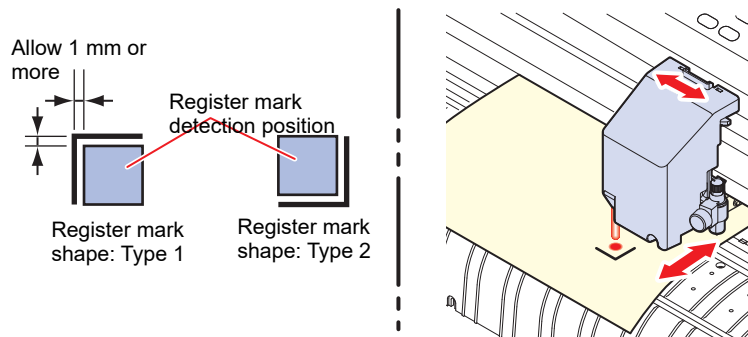
**3 Use ▲▼◀▶ to move the LED pointer close to the center of the register mark detection position, as shown in the following figure.****4 Press the [ENTER/HOLD] key.**

- The scale compensation setting screen appears.

5 Use ▲▼ to set the scale correction value.

- Press the [ENTER/HOLD] key to proceed to the next scale compensation setting.
- If [DIST.REVI.] is set to [OFF], the screen for setting scale compensation does not appear.
- If [MARK DETECT] is set to [2ptA], the screen for entering distance B does not appear.
- If [MARK DETECT] is set to [2ptB], the screen for entering distance A does not appear.
- If [MARK DETECT] is set to [1pt], the origin is displayed, and the scale compensation screen does not appear. (Step 7)

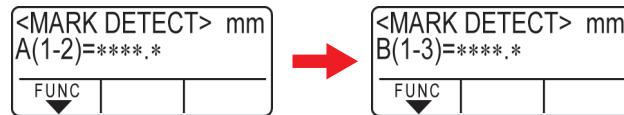

6 Press the [ENTER/HOLD] key after setting.

- Register mark detection starts as set using [MARK DETECT].
- [ERROR C36 MARKdetect] appears on the display if no register marks can be detected. If this occurs, reload the sheet.



- For more information on the number of register marks detected, refer to "Register mark detection points setting [MARK DETECT]"(P. 85).

7 Display the origin.

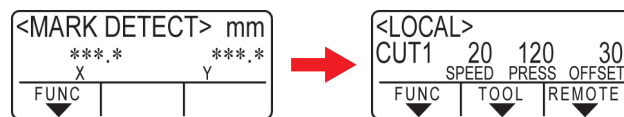

- The available cutting area is displayed following register mark detection, before switching to local mode.

Detection procedure using rear specification

1 Perform steps 1 to 3 of "Detection procedure using front specification"(P. 90).

2 Press the [ENTER/HOLD] key.

- Register mark detection starts as set using [MARK DETECT].
- [ERROR C36 MARKdetect] appears on the display if no register marks can be detected. If this occurs, reload the sheet.



- For more information on the number of register marks detected, refer to "Register mark detection points setting [MARK DETECT]"(P. 85).

3 Once the register marks have been detected, set using the scale compensation setting screen.

- The following example shows the procedure for four-point detection.
 - Set using \blacktriangle \blacktriangledown if the detected register mark distances differ from the measured values.
 - Press the [ENTER/HOLD] key to proceed to the next scale compensation setting.
- If [DIST.REVI.] is set to [OFF], the screen for setting scale compensation does not appear.
- If [MARK DETECT] is set to [2ptA], the screen for entering distance B does not appear.
- If [MARK DETECT] is set to [2ptB], the screen for entering distance A does not appear.
- If [MARK DETECT] is set to [1pt], the scale compensation screen does not appear. Proceed to Step 4, and set the origin.

4 Press the [ENTER/HOLD] key after setting.

- Set the origin.
- The available cutting area is displayed before switching to local mode.

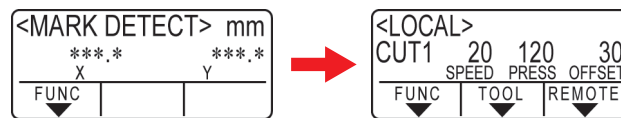

Detecting Register Marks Automatically After Sheet Detection

Set the automatic register mark search function after sheet detection.

Register marks will be searched for automatically after sheet detection provided both register mark detection and registration mark searching are enabled.

Bidirectional scans are made over the preset scanning width from the origin after sheet detection at a spacing corresponding to half the register mark size. Register mark detection is then performed when lines, points, or printed objects are discovered.

Once the vertical and horizontal lines of a register mark have been detected, this is recognized as a register mark, and the origin is set.

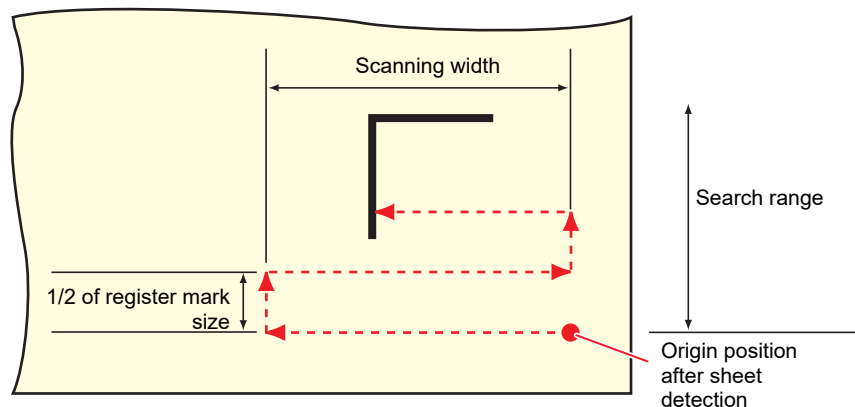

- Press the [FUNCTION] key in local mode.
- Use \blacktriangle \blacktriangledown to select [SET UP], then press the [ENTER/HOLD] key.
- Use \blacktriangle \blacktriangledown to select [SEARCH MARK], then press the [ENTER/HOLD] key.
- Use \blacktriangle \blacktriangledown to select [ON], then press the [ENTER/HOLD] key.

5 Use ▲▼ to select the width to be scanned, then press the [ENTER/HOLD] key.

- Setting: 10 to 30 cm

6 Use ▲▼ to select the search range, then press the [ENTER/HOLD] key.

- Setting: 10 to 50cm

7 Press the [END] key several times to exit.



- If marks are not recognized as register marks or if no response is obtained even after scanning the set search range, the "SEARCH FAILED" message appears for a preset length of time. The machine then returns to the origin position and switches to normal semi-automatic register mark detection mode.
-

3.5 ID Cut Process



- For more information, refer to the ID Cut Guide. <https://mimaki.com/download/software.html>

For information on the ID cut register mark scanning range, refer to "This machine can detect register marks in the range shown in the above figure."(P. 83).

1. Create data with ID Cut.

2. Print printing data with ID Cut.

3. Prepare for cutting.

"Cutting Process"(P. 42) (Steps 1 to 8)

4. Register the information for the printed register marks.

"Setting Register Mark Detection Conditions"(P. 85)

5. Detect register marks.

"Detect register marks."(P. 89)

6. Cut the data.

"Cut the data."(P. 73)

7. Separate sheets.

"Separating Sheets (Manual Cutting)"(P. 75)

Chapter 4 Helpful Tips



This chapter

Describes operation methods for convenient use.

Jog Mode Functions	100	Other Useful Functions.....	120
2-Point Line Correction [AXIS CORRECT]		Sheet Feed	120
.....	100	Pause [HOLD].....	120
Cut Area Setting [CUT AREA].....	101	Feed Settings [FEED OPTION]	121
Digitizing [DIGITIZE]	101	Preventing Uncut Media [OVER CUT/ CORNER CUT]	123
Length Correction [DIST.COMP.].....	103	Configuring the Network Settings [NETWORK].....	124
Cutting Multiple Copies of the Same Data [MULTI COPY].....	106	Event Email Function Settings [EVENT MAIL]	125
Expanding the Cutting Area [EXPANDS]	108	Outputting the Settings List [LIST]	129
Selecting the Cutting Movement Direction [ROTATION].....	109	Copying Settings from Other User Settings [CONFIG COPY].....	130
Setting Rotation.....	109	Restoring Default Settings [SETUP RESET]	130
Divided Cutting [DIVISIONcut]	111	Changing Users [CHANGE USER].....	131
Y Direction (Width Direction) Divided Cutting	112	Outputting Received Data as ASCII Code [DUMP]	131
X Direction (Feed Direction) Divided Cutting	114	Selecting the Screen Display Language [DISPLAY].....	131
Changing the Cutting Sequence [SORTING]	116	Checking Machine Information [INFORMATION].....	132
Setting Sorting.....	117		
Sorting Procedure	117		
Operating the Main Unit Panel Remotely [R.CONTRL]	118		

4.1 Jog Mode Functions

The jog keys can be used to switch from local mode to jog mode. Jog mode allows the following items to be set or executed.

Function name	Details	Reference page
Origin setting (ORIGIN SET)	Sets the cutting (printing) start position.	"Setting the Origin"(P. 73)
2-Point line correction (AXIS CORRECT)	Aligns the vertical and horizontal axes of the machine with the vertical and horizontal lines printed on the loaded graph paper.	"2-Point Line Correction [AXIS CORRECT]"(P. 100)
Cut area setting (CUT AREA)	Sets the cutting (printing) range.	"Cut Area Setting [CUT AREA]"(P. 101)
Pen up/down	Press the [TOOL] key to move the tool up and down.	-

Important!

- Check to confirm that no cut (print) data is present before setting functions using jog mode.
- If positions such as the origin are specified in jog mode, the center of the tool will coincide with the specified position regardless of whether the LED pointer is on or off.

2-Point Line Correction [AXIS CORRECT]

Aligns the vertical and horizontal axes of the machine with the vertical and horizontal lines printed on the loaded graph paper.

Corrects the axis tilt (θ) using the set origin and correction point.

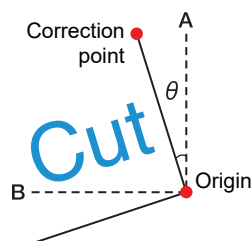

- 1 Press the [REMOTE] key to select local mode.
 - Press the [REMOTE] key to confirm beforehand that cutting (printing) is not performed even in remote mode.
- 2 Use to set the origin, then press the [ENTER/HOLD] key.
- 3 Use to select jog mode.
- 4 Press the [SHEET] key.
- 5 Use to move to the correction point.
 - θ range: -45° to 45°
- 6 Press the [ENTER/HOLD] key to confirm the correction point.
 - The message "AXIS CORRECT $\theta = **$ " appears for a short time, before the machine reverts to local mode.



- To clear the correction point, first push the clamp lever back to the rear, then repeat sheet detection. "Note about sheet detection"(P. 45)

Cut Area Setting [CUT AREA]

The cut area is set by the range extending from the origin to the diagonally opposite UL (upper left) point set by the user. Set the UL point position here.

Repeating sheet detection will clear the cut area.

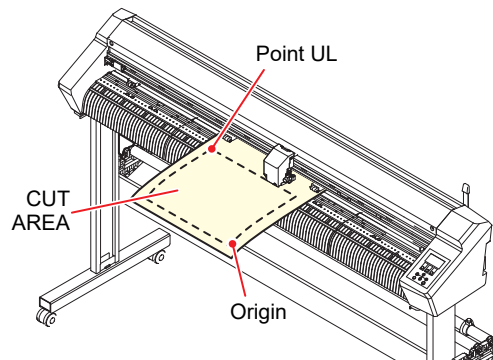

1 Press the [REMOTE] key to select local mode.

- Press the [REMOTE] key to confirm beforehand that cutting (printing) is not performed even in remote mode.

2 Use ▲▼◀▶ to select jog mode.

3 Press the [FEED] key.

4 Use ▲▼◀▶ to set the UL point.

5 Press the [ENTER/HOLD] key to confirm the UL point.

- The "CUT AREA *.*.*" screen appears for a short time, before the machine reverts to local mode.



- Set the UL point in the positive direction from the origin.
- Set the origin within the cut area. An operation error will occur if it is set outside the cut area. ["Note about the cutting area"\(P. 44\)](#)

Digitizing [DIGITIZE]

The coordinates from the origin of the image printed are displayed on the host computer.

Digitizing is enabled once the digitize command (DP;) has been received from the host computer.

To digitize, load a sheet with a pattern specifying the points.



- The digitizing operation is available only with application software that includes the digitize function. For information on how to use the function, refer to the operation manual for the application software.

1 Select remote mode, then receive the digitize command from the host computer.

- The screen display changes as follows:



2 Use ▲▼◀▶ to move the pen nib to the desired point on the print.

- The coordinates from the origin are displayed.
- Reducing the step units with the jog step function enables the point to be specified more precisely.
 ["JOG STEP"\(P. 140\)](#)

3 Press the [ENTER/HOLD] key.

- Record the pen nib point.
- Receive the coordinate output command (OD;) from the host computer.

4.2 Length Correction [DIST.COMP.]

When cutting long data, discrepancies in the cut length may arise due to the sheet thickness. Differences in grit roller diameter may also cause discrepancies in feed rate between the left and right sides of the sheet.

Such discrepancies can be corrected using the length correction function.

Up to 8 length correction value types (No. 1 to No. 8) can be registered.

● Calculating the correction value

Correction value = (Measured length of OFF line) - (Entered standard length)

Example:

- Measured length of OFF line: 999.0 mm
- Entered standard length: 1,000 mm
- $999.0 - 1,000 = -1.0$ mm / (correction value)

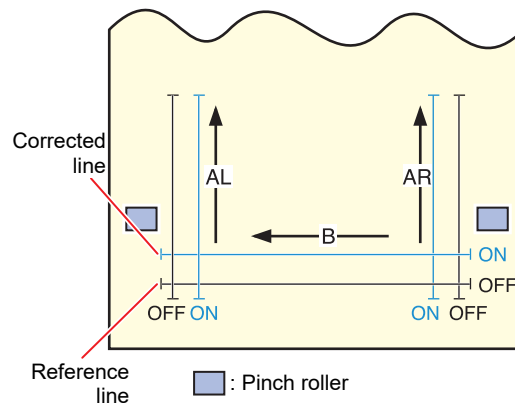

Settings:

- Standard value
 - A direction: 500, 1000, 1500, 2000, 2500 (mm)
 - B direction (CG-60AR): 200, 400, 600 (mm)
 - B direction (CG-100AR): 200, 400, 600, 800, 1000 (mm)
 - B direction (CG-130AR): 200, 400, 600, 800, 1000, 1200 (mm)
- Correction value
 - A direction: $\pm 5\%$ of standard length (0.1 mm steps)
 - B direction: $\pm 5\%$ of standard length (0.1 mm steps)
- Plotting offset: 0 to 300 mm

● Setting procedure

1 Attach a pen.

- "Using a Pen"(P. 63)

2 Load a sheet.

- "Loading a Sheet"(P. 44)
- Load the sheet on which the length correction adjustment pattern is to be printed.

3 Press the [FUNCTION] key in local mode.

4 Use to select [DIST.COMP.], then press the [ENTER/HOLD] key.

- The correction values saved for No. 1 AR (longitudinal direction right-hand side), AL (longitudinal direction left-hand side), and B (lateral direction) are displayed.

- 5** Use ▲▼ to select the distance correction number to be saved, then press the [ENTER/HOLD] key.
- The previously corrected standard length (mm) is displayed.
 - If length correction has never been performed, the minimum standard length will be displayed.
 - If the length units [MM/INCH] have been changed since the previous correction, the display will appear as "A=---- B=----".
- 6** Use ▲▼ to alter the standard length in the A (longitudinal) direction.
- The A direction standard length forms the standard length for both AR (right-hand side longitudinal direction) and AL (left-hand side longitudinal direction).
 - Altering the standard length clears the previously corrected distance correction values (AR and AL).
- 7** Press the [ENTER/HOLD] key to confirm the A direction standard length.
- The B direction standard length can now be set.
- 8** Use ▲▼ to alter the standard length in the B (lateral) direction.
- Altering the standard length clears the previously corrected distance correction value (B).
- 9** Press the [ENTER/HOLD] key to confirm the B direction standard length.
- 10** Use ▲▼ to specify the printing position for the distance correction adjustment pattern, then press the [ENTER/HOLD] key.
- All of the lines (AR, AL, and B) will be offset within the sheet.
 - The adjustment pattern will be printed out.
 - The adjustment pattern will not be printed if no sheet has been loaded or if the sheet is too small to allow the standard length to be printed.
In such cases, press the [ENTER/HOLD] key to display the correction value input screen.
- 11** The current correction values are displayed once printing is complete.
- 12** Measure the AR, AL, and B OFF lines.
- Push the clamp lever to the rear to release the sheet for measurement.

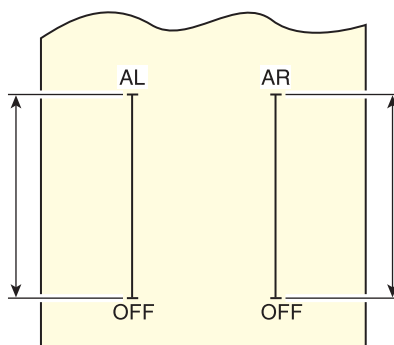

- 13** Perform steps 3 to 10.
- As no sheet is loaded, printing will not occur, and the correction value input screen will appear.
- 14** If the measurement differs from the standard value, use ▲▼ to alter the correction value.

15 Press the [ENTER/HOLD] key to confirm the AR direction correction value.

- This can also be confirmed by pressing the ► key.
- The AL direction standard length can now be set.

16 If the measurement differs from the standard value, use ▲▼ to alter the AL correction value.

17 Press the [ENTER/HOLD] key to confirm the AL direction correction value.

- This can also be confirmed by pressing the ► key.
- The B direction standard length can now be set.

18 If the measurement differs from the standard value, use ▲▼ to alter the B correction value.

19 Press the [ENTER/HOLD] key to confirm the B direction correction value.

- Pressing the [END] returns to the display in step 3.

4.3 Cutting Multiple Copies of the Same Data [MULTI COPY]

You can cut the data stored in the receive buffer of the machine by the specified number (up to 999 sheets).

- The last cutting data is stored in the receive buffer. When new data is received, the already saved data is overwritten.
- Reset the origin before executing [MULTI COPY]. Failure to do so will result in overlap cutting.

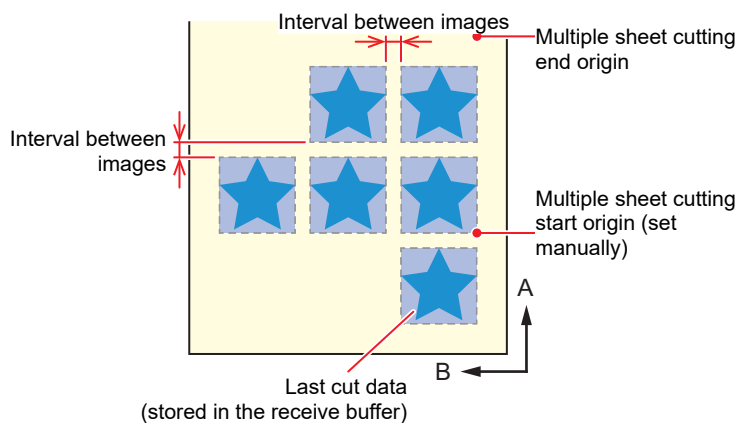

- The machine cuts the specified number of sheets of the divided cut data without separating the data.



- If you are using FineCut/Coat9, deselect the [Sheet Feed Origin Renewal] checkbox. (This is unselected by default.)
- [MULTI COPY] cannot be executed if the cut data contains an origin renewal command.
- When sending the cut data from the PC, wait for at least 5 seconds before sending the next data. If the next data is sent within 5 seconds, both pieces of data may be copied. This time period can be altered using the close time setting. [☞ "Notes on the setting items"\(P. 35\)](#)
- Data will not be cut if the origin updated within the machine does not lie within the available cutting area while two-point line correction is being set. [☞ "Note about the cutting area"\(P. 44\)](#)



- If the origin mode is set to "CENTER", the intended cutting results may not be achieved. With multiple sheet cutting, it is recommended to set the origin to "Low-R".

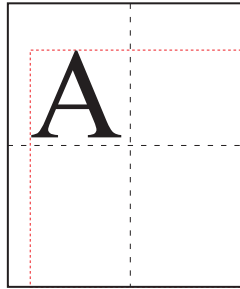

If the center origin is used, the data size will extend from the minimum cutting range position to the diagonally opposite maximum data size (range indicated by broken red line), resulting in excessive margins for data, as shown in the figure.

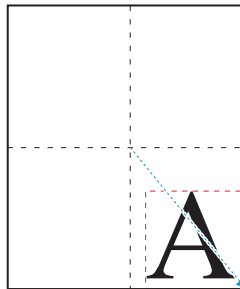

When using the center origin, the origin position should be taken into consideration in applications such as FineCut/Coat9, and the data should be output to a position with negative coordinates from the origin. Copying uses data with a negative offset applied (indicated by blue arrow), so updating the origin for multiple sheet cutting results in cutting displaced from the origin position.

The first image will therefore be cut in duplicate, but multiple sheet cutting must be performed without updating the origin when using the center origin.

- 1 Use ▲▼ in local mode to move the carriage to the origin, in order to start multiple sheet cutting.
- 2 Press the [ENTER/HOLD] key to set the origin.
- 3 Press the [FUNCTION] key in local mode.
- 4 Use ▲▼ to select [MULTI COPY], then press the [ENTER/HOLD] key.
- 5 Use ▲▼ to select the number of copies to be cut (1 to 999), then press the [ENTER/HOLD] key.
- 6 Use ▲▼ to select the interval between images to be cut (0 to 30 mm), then press the [ENTER/HOLD] key.
 - Multiple sheet cutting starts.

4.4 Expanding the Cutting Area [EXPANDS]

The cutting (printing) area can be expanded to reduce non-printing areas. (Expand function)
Expanding the cutting area allows non-printing areas at the front and sides to be reduced by 10 mm.

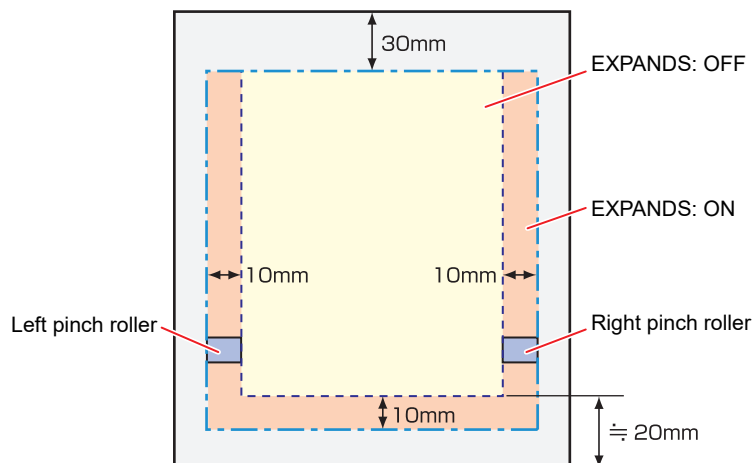

- 1** Press the [FUNCTION] key in local mode.
- 2** Use ▲▼ to select [SET UP], then press the [ENTER/HOLD] key.
- 3** Use ▲▼ to select [EXPANDS], then press the [ENTER/HOLD] key.
- 4** Use ▲▼ to select [ON], then press the [ENTER/HOLD] key.
- 5** Press the [END] key several times to exit.



- Enabling expand mode may result in paper jamming if excessive pressure is applied.
- If line correction is not performed, the cutting blade may move off the edge of the sheet, causing paper jamming or damaging the cutting blade or machine.
- Cutting quality will be reduced if the cut part is fed by the pinch rollers.
- Register marks may not be correctly detected if the pinch rollers move over the register marks during register mark detection.
- Repeat sheet detection if the expand setting was changed after sheet detection.

4.5 Selecting the Cutting Movement Direction [ROTATION]

Set the origin position and direction of the coordinate axes to match the application software being used. (Rotation function)

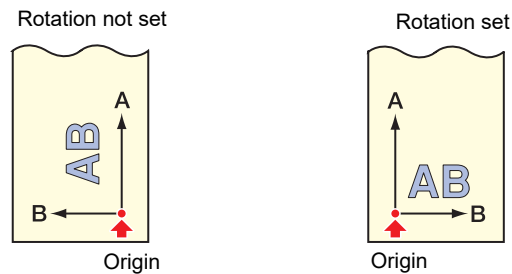

The carriage stops at the origin position after sheet detection.



- The settings are retained even when the power is turned off.
- Check to confirm that no data to be cut has been saved in the receive buffer. Altering the setting clears the receive buffer contents.
- Rotation cannot be enabled if the register mark detection function is enabled.
- First turn off the register mark function before enabling rotation.  "Detect register marks." (P. 89)
- Altering the rotation setting initializes the cut area settings.

Setting Rotation

- 1 Press the [FUNCTION] key in local mode.
- 2 Use ▲▼ to select [SET UP], then press the [ENTER/HOLD] key.
- 3 Use ▲▼ to select [ROTATION], then press the [ENTER/HOLD] key.
- 4 Use ▲▼ to select [ON] or [OFF], then press the [ENTER/HOLD] key.
 - ON: The coordinate axes are rotated and the origin is moved at the same time.
 - OFF: No rotation is performed.
- 5 Press the [END] key several times to exit.

● **Note about coordinate systems**

This machine uses the following four coordinate systems, in accordance with the combination of sheet loading direction and rotation function:

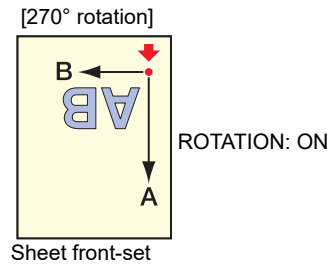
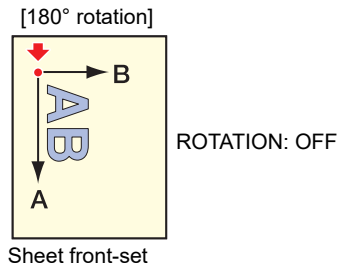
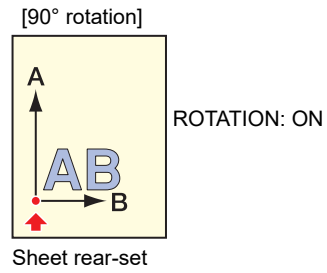
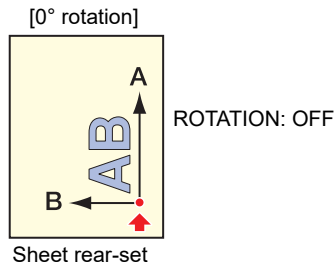

4.6 Divided Cutting [DIVISIONcut]

Setting divided cutting in the width (Y) direction allows data larger than the sheet width to be divided and cut. (Divided cutting function)

Similarly, setting divided cutting in the feed (X) direction allows long data to be divided and cut, minimizing cutting deviations due to sheet meandering.

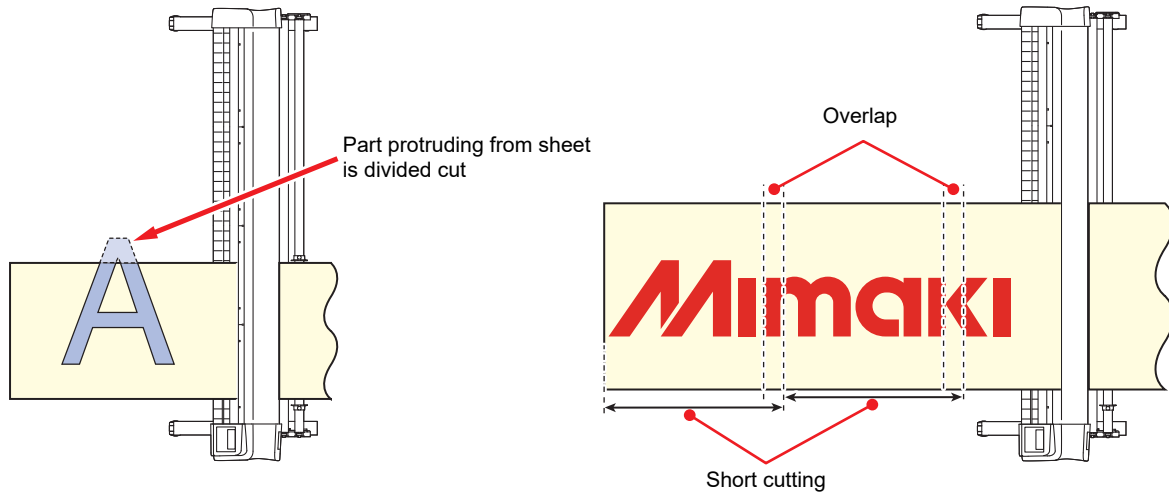

The following conditions are recommended for divided cutting with long data. Large discrepancies may occur at the division positions if the following conditions are not satisfied:

- Attach the sheet basket (option).
- When using heavy roll sheets, set [SHEET TYPE] to [HEAVY].
- Some sheet types may not be able to withstand high-speed operations. If so, reduce the cutting speed.
- Three pinch rollers should be used if the sheet width is 1 m or more.
- If there is not adequate space in front of or behind the machine, reduce the speed or up speed.
- The roll sheet drawn out may reverse and be taken up due to vibrations during the cutting process when cutting complex data. Motor alarms are particularly likely to occur when using high-speed operations. Increase the feed offset setting to prevent high-speed operation. (Limit the speed to below 40 cm/s)
- Limit the total length of long data for cutting with a single division to 10 m. When cutting data more than 10 m long, divide into multiple sections. If the cutting data is too long, it may become distorted while layered, possibly causing cutting discrepancies and paper jamming.

4



Divided cutting includes the following features. The following features are available only for divided cutting in the Y (width) direction.

- Frame cutting:
Automatically cuts a frame to suit the cutting data together with the cutting data itself.
- Addition of overlap margin marks:
Marks can be added as a guide to assist in pasting sheets together after they have been divided cut.

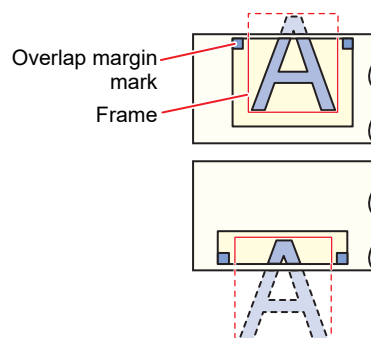

Y Direction (Width Direction) Divided Cutting

Setting Y Direction (Width Direction) Divided Cutting

- 1 Press the [FUNCTION] key in local mode.
- 2 Use ▲▼ to select [SET UP], then press the [ENTER/HOLD] key.
- 3 Use ▲▼ to select [DIVISIONcut], then press the [ENTER/HOLD] key.
- 4 Use ▲▼ to select [Y], then press the [ENTER/HOLD] key.
- 5 Use ▲▼ to select the [FRAME CUT] setting, then press the [ENTER/HOLD] key.
 - Select [ON] if frame cutting is required.
- 6 Use ▲▼ to select the [MARK CUT] setting, then press the [ENTER/HOLD] key.
 - Select [ON] if overlap margin marks are required.
- 7 Press the [END] key several times to exit.

Important!

- The settings are retained even when the power is turned off.
- The overlap margin measures 1 cm, so a width of at least 1 cm is required for the available cutting area.
- The data from the host computer can be ignored during divided cutting.
- Divided cutting is not possible in any of the following cases:
 - If the volume of cutting data exceeds the size of the receive buffer
 - If the cutting data contains an origin update command
 - If two-point line correction is set
 - If register mark detection is used
 - If the available cutting area is 1 cm or less
 - If test data has been cut within the machine
- Deselect the check box when divided cutting is used. (When FineCut/Coat9 is used, the default setting for the origin update command is "OFF". Refer to "5 Setting Head Position after Plotting" in the FineCut/Coat9 Reference Guide.)

Cutting Data Using Y Direction (Width Direction) Divided Cutting

- 1 Receive the data from the computer.
 - Cutting starts.
 - If data protrudes beyond the cutting area, it will appear as shown below, and the protruding part of the data will not be cut.

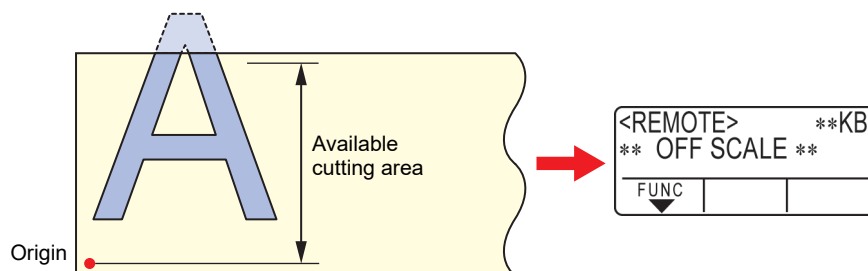



When [FRAME CUT] or [MARK CUT] is set to [ON]

- Once cutting is complete, the frame and overlap margin marks will be automatically cut.

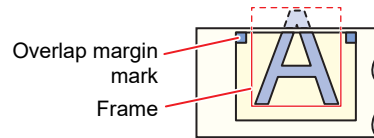

- The display indicates the time remaining until frame and mark cutting is complete.
- The display switches to local mode once frame and mark cutting is complete. The sheet can be replaced once the machine has switched to local mode. Do not replace the sheet other than in local mode.

2 Set a new origin.

- Use the jog keys to move the carriage and set the origin.
- Replace the sheet if there is no cutting space.

3 Press the [REMOTE] key to select remote mode.

- The sheet will be fed corresponding to the maximum sheet length for the cutting data, then cutting starts.

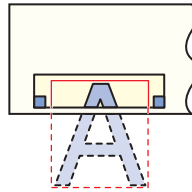

- If the sheet is not fed or if the sheet is too short, replace with a longer sheet in Step 2.

4 Repeat Steps 2 and 3.

- This continues until there is no longer any data exceeding the sheet width.
- Once complete, the tool conditions are displayed, and the machine returns to local mode.

X Direction (Feed Direction) Divided Cutting

Setting X Direction (Feed Direction) Divided Cutting

The data size in the feed direction will be cut divided at the positions corresponding to [Division Length + Cross Cut Length].

Setting the cross cut length cuts at the [Cut Length] position overlapping by the amount of the setting.

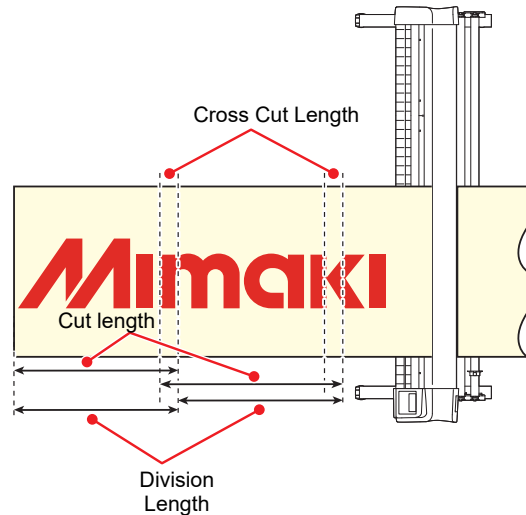

- 1** Press the [FUNCTION] key in local mode.
- 2** Use ▲▼ to select [SET UP], then press the [ENTER/HOLD] key.
- 3** Use ▲▼ to select [DIVISIONcut], then press the [ENTER/HOLD] key.
- 4** Use ▲▼ to select [X], then press the [ENTER/HOLD] key.
- 5** Use ▲▼ to select [DIV.LENG], then press the [ENTER/HOLD] key.
 - Setting: 50 to 500 cm (in 50 cm increments)
- 6** Use ▲▼ to select the [CROSS CUT] setting, then press the [ENTER/HOLD] key.
 - Setting: 0 to 50mm (in 1mm increments)
 - The sheet is cut with overlaps corresponding to the amount of the setting.
- 7** Press the [END] key several times to exit.

Important!

- The settings are retained even when the power is turned off.
- The data from the host computer can be ignored during divided cutting.
- Divided cutting is not possible in the following cases:
 - If the volume of cutting data exceeds the size of the receive buffer
 - If the cutting data contains an origin update command
 - If two-point line correction is set
 - If register mark detection is used
 - If the available cutting area is 1 cm or less
 - If test data has been cut within the machine

Cutting Data Using X Direction (Feed Direction) Divided Cutting

1 Receive the data from the computer.

- Cutting starts.
- Long data is automatically divided, and each division length is cut by feeding the length to be cut.
- The sheet is fed once cutting is complete within the set range, and cutting starts automatically provided the end of the sheet has not been reached. Once cutting is complete, the tool conditions are displayed, and the machine returns to local mode.
- X direction (feed direction) divided cutting ends when the end of the sheet is reached.

4.7 Changing the Cutting Sequence [SORTING]

Cutting data sent from the host computer can be reordered to change the cutting sequence. (Sorting function)

If the order of data sent from the application software prevents data from being cut using a single cut, the cutting sequence can be altered to enable the data to be cut using a single cut. (This function may not be supported depending on the firmware version.)



Cutting using a single cut will not be possible in the following case, even when the sorting function is used:

- Depending on the application software, data may be sent to the plotter in the sequence in which it was created/edited. Single-cut cutting will not be possible in cases where data imported using a scanner has been modified, as the modified parts will be cut at the end.

● Precautions when cutting using the sorting function

Sorting enables cutting in individual blocks, where one block corresponds to movement with the pen down to raising the pen.

Once one block has been cut, the block with the nearest origin position is then cut.

The host data start point and cutting direction are not changed.

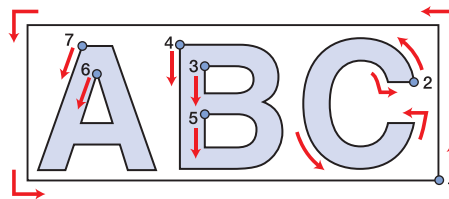

- mark: Data start point = Cutting start point
- Arrow: Data direction = Cutting direction
- Numbers: Cutting block sequence

● Features of the sorting function

Enabling the sorting function enables the following functions:

- Auto feed function:
This function detects the length of the data to be cut and pulls out the length of sheet corresponding to the data length in advance.
- Area management function:
Areas can be specified in advance to cut block data contained within that area first. Once there is no longer any block data remaining within the area, the area is expanded and cutting proceeds gradually in the sheet feed direction.

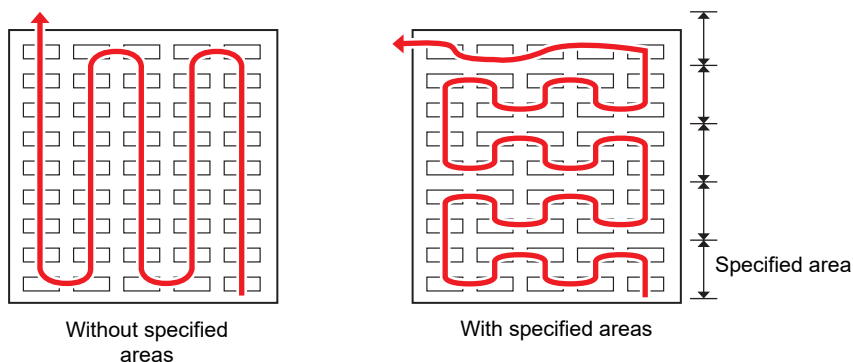

Setting Sorting

- 1 Press the [FUNCTION] key in local mode.
- 2 Use ▲▼ to select [SET UP], then press the [ENTER/HOLD] key.
- 3 Use ▲▼ to select [SORTING], then press the [ENTER/HOLD] key.
- 4 Use ▼ to select [ON], then press the [ENTER/HOLD] key.
- 5 Use ▲▼ to select the [AUTO FEED] setting, then press the [ENTER/HOLD] key.
 - Select [ON] if auto feed is required.
- 6 Use ▲▼ to select the [AREA] setting, then press the [ENTER/HOLD] key.
 - Setting: OFF or 10 to 5,100 cm (in 10 cm increments)
- 7 Press the [END] key several times to exit.

Important!

- The settings are retained even when the power is turned off.
- Altering the setting clears the receive buffer contents.
- Enabling sorting reduces the receive buffer size to approximately 20 MB.

Sorting Procedure

- 1 **Send the data.**
 - The size of unprocessed data within the receive buffer is displayed.
 - Cutting (printing) is not performed.
 - Processed line segments are loaded into the sorting buffer.
 - Once the data has been sent, the waiting time until cutting starts is displayed.
 - The remaining time is displayed in seconds.
 - The countdown starts provided no data is received while waiting for cutting to start.
- 2 **Use auto feed.**
 - The sheet is pulled out by the amount corresponding to the cut before cutting starts.
 - Send data or perform multiple sheet cutting after replacing with a long sheet.  ["Cutting Multiple Copies of the Same Data \[MULTI COPY\]"\(P. 106\)](#)
- 3 **Start cutting.**
 - The progress of the data that has been cut is displayed as a percentage.
 - The machine switches to remote mode once cutting is complete.



When the sorting function is enabled, cutting does not start after all of the cutting data has been received until the close time has elapsed.  ["Notes on the setting items"\(P. 35\)](#) However, sorting and cutting will start before the close time has elapsed in the following cases:

- When the sorting buffer becomes full (with approximately 500,000 line segments)
- When the cut conditions, such as tool number, speed, and pressure, have been changed
- When the feed command or origin update command has been executed

4.8 Operating the Main Unit Panel Remotely [R.CONTRL]

Enabling remote control allows the machine to be operated remotely using Mimaki Remote Access without having to use the operating panel on the machine.











- Mimaki Remote Access is a remote access tool that allows information collection and panel operations from locations other than at the Mimaki printer or plotter. For more information, refer to Mimaki Remote Access online help.

https://mimaki.com/manual/mimaki-remote-access/online_help/

When <variable linkid="1142544908" name="1002">Mimaki Remote Access</variable> is being used, "Under remote controlling. Cancel> [ENT]" is displayed on the display and the keys on the machine operating panel are disabled.

Pressing the [ENTER/HOLD] key on the "Under remote controlling. Cancel> [ENT]" cancels the remote control state from Mimaki Remote Access, and allows operations using the machine's operating panel.

For information on the operating panel keys, refer to  "Display"(P. 31).

- 1 Press the [FUNCTION] key in local mode, use   to select [SET UP], then press the [ENTER/HOLD] key.
- 2 Use   to select [R.CONTRL], then press the [ENTER/HOLD] key.
- 3 Press the [ENTER/HOLD] key on the [Permit:***] screen.
- 4 Use   to select [ENABLE] or [DISABLE], then press the [ENTER/HOLD] key.
 - [ENABLE]: Enables remote control using Mimaki Remote Access.
 - [DISABLE]: Disables remote control using Mimaki Remote Access. If [DISABLE] is selected, press the [END] key several times to exit.
- 5 Use   to select [PIN code], then press the [ENTER/HOLD] key.
- 6 Use   to set the PIN code, then press the [ENTER/HOLD] key.
 - The PIN code is a four-digit number used for Mimaki Remote Access authorization. Initial value: 0000
 - Settings: Set a four-digit number between 0000 and 9999.



Connecting from Mimaki Remote Access

Enter the four-digit number corresponding to the PIN code set for the machine on the PIN code input screen for authorization.

- When set to "0000"
 - Any four-digit number (any four-digit combination except for "0000")
- Setting other than "0000"
 - The same four-digit number as the setting



- Note that setting the PIN code to "0000" allows authorization for any number.

- 7 Use   to select [KeyLife:**[Min]], then press the [ENTER/HOLD] key.

- 8** Use ▲▼ to set the key life time, then press the [ENTER/HOLD] key.
- The key life time is used to set the time until remote control is automatically exited when there is no activity during remote control with Mimaki Remote Access.
 - Remote control ends if there is no activity over the time set for Mimaki Remote Access following PIN code authorization.
Settings: 5 to 120 (minutes)
- 9** Press the [END] key several times to exit.

4.9 Other Useful Functions

Sheet Feed

The sheet can be pulled out in advance before cutting (or printing). This allows any sheet skew to be checked and prevented.

- Important!**
- High-speed cutting with a roll sheet still rolled up may result in errors if the sheet drive is unable to keep up.
 - The feed function cannot be enabled unless the sheet has been detected.

- 1 Press the [FUNCTION] key in local mode.**
- 2 Use ▲▼ to select [SHEET FEED], then press the [ENTER/HOLD] key.**
- 3 Use ▲▼ to enter the length for pulling out the sheet, then press the [ENTER/HOLD] key.**
 - Setting: 0.1 m to 51.0 m (in 0.1 m increments)
 - The sheet is pulled out by the length corresponding to the entered length plus the feed offset.  ["Feed Settings \[FEED OPTION\]" \(P. 121\)](#)



- To stop sheet feed midway, press the [END] key.

Pause [HOLD]

If the sheet becomes skewed while cutting (or printing) long data, cutting can be paused to correct any skew.

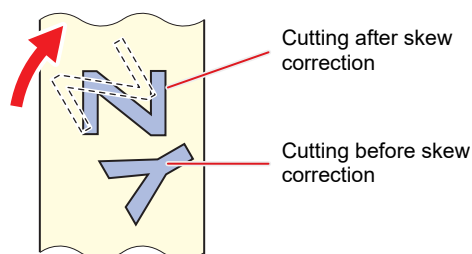

- Important!**
- Do not move the carriage or pinch roller positions when correcting skew. Disregarding this precaution may damage the machine or cause an error.

- 1 Press the [ENTER/HOLD] key while cutting is in progress.**
 - Press the [ENTER/HOLD] key in between individual cuts for an image. Pausing midway while cutting a line will cause the cut line to become misaligned.
- 2 Correct the sheet skew.**
 - (1) Push the clamp lever to the rear.
 - (2) Correct the sheet skew.
 - (3) Pull the clamp lever toward you.
 - (4) Press the [END] key.
- 3 Press the [REMOTE] key to restart cutting.**



- The [ENTER/HOLD] becomes available once sheet detection has ended.
- In local mode, hold down the [ENTER/HOLD] key for at least approximately 2.5 seconds.

Feed Settings [FEED OPTION]

Various feed related settings can be set.

Function name	Outline	Refer to
FEED OFFSET	Feeds slightly more sheet when feeding the sheet.	"FEED OFFSET Setting"(P. 121)
FEED SPEED	Reduces the feed speed to reduce the load when using heavier sheets.	"FEED SPEED Setting"(P. 121)
PRE FEED	Sets automatic sheet feeding performed after sheet detection.	"PRE FEED Setting"(P. 122)
VIEW FEED	Switches "ON (enable)/OFF (disable)" of feed operation after test cut.	"VIEW FEED Setting"(P. 123)

FEED OFFSET Setting

This enables slightly more sheet to be fed when feeding the sheet such as with pre-feed. This ensures sufficient slack as required when cutting (or printing).

If only a little amount of sheet remains on the roll, the roll sheet may be wound back on to the roll by the vibration occurring during operation, leaving insufficient slack and preventing accurate cutting (or printing). Feeding slightly more sheet minimizes such issues.



- The settings are retained even when the power is turned off.
- The [FEED OFFSET] setting is disabled when [OVER FEED] is set.

- 1 Press the [FUNCTION] key in local mode.
- 2 Use ▲▼ to select [SET UP], then press the [ENTER/HOLD] key.
- 3 Use ▲▼ to select [FEED OPTION], then press the [ENTER/HOLD] key.
- 4 Use ▲▼ to select [FEED OFFSET], then press the [ENTER/HOLD] key.
- 5 Use ▲▼ to select the offset, then press the [ENTER/HOLD] key.
 - Setting: 0 to 100cm
- 6 Press the [END] key several times to exit.

FEED SPEED Setting

The feed speed can be reduced to reduce the load when using heavier sheets.

- 1 Press the [FUNCTION] key in local mode.
- 2 Use ▲▼ to select [SET UP], then press the [ENTER/HOLD] key.
- 3 Use ▲▼ to select [FEED OPTION], then press the [ENTER/HOLD] key.
- 4 Use ▲▼ to select [FEED SPEED], then press the [ENTER/HOLD] key.

5 Use ▲▼ to select the feed speed, then press the [ENTER/HOLD] key.

- Setting: 1 to 30 cm/s

6 Press the [END] key several times to exit.

PRE FEED Setting

The following automatic sheet feed items can be set to be performed after sheet detection.

Item	Setting	Initial value	Outline
Feed count (FEED COUNT)	OFF, 1 to 5 (times)	OFF	Sets the number of times the sheet is fed backward and forward. Feeding the sheet increases the cutting (or printing) quality. <ul style="list-style-type: none"> • The feed count should be set to around 3 (times). • Adjust the feed count setting to suit the type of sheet used.
Feed length (FEED LENG)	0.1 to 5.0m	0.3	Sets the length of sheet to be fed. Feeding the length of sheet to be cut (or printed) beforehand allows the sheet to adjust to the ambient conditions and increases the cutting (or printing) quality.
Waiting time (TIME WAIT)	0 to 90 seconds	1	Sets the time from feeding the sheet until cutting (or printing) starts.
OVER FEED	ON/OFF	OFF	When cutting (or printing) two or more pages, feeding the second sheet in advance increases the cutting (or printing) efficiency when the waiting time has been set.

1 Press the [FUNCTION] key in local mode.

2 Use ▲▼ to select [SET UP], then press the [ENTER/HOLD] key.

3 Use ▲▼ to select [FEED OPTION], then press the [ENTER/HOLD] key.

4 Use ▲▼ to select [PRE FEED], then press the [ENTER/HOLD] key.

- The feed count setting is displayed.

5 Use ▲▼ to select the setting, then press the [ENTER/HOLD] key.

- Setting: OFF, 1 to 5

6 Repeat Step 5 to set any other items.

- Set all of the other items using the same procedure as in Step 5.

7 Press the [ENTER/HOLD] key once all of the items have been set.

8 Press the [END] key several times to exit.



- The settings are retained even when the power is turned off.

VIEW FEED Setting

The view feed can be set to enable/disable feed operation after test cut.

- 1 Press the [FUNCTION] key in local mode.
- 2 Use ▲▼ to select [SET UP], then press the [ENTER/HOLD] key.
- 3 Use ▲▼ to select [FEED OPTION], then press the [ENTER/HOLD] key.
- 4 Use ▲▼ to select [VIEW FEED], then press the [ENTER/HOLD] key.
- 5 Use ▲▼ to select the setting, and press the [ENTER/HOLD] key.
 - Setting: ON/ OFF
- 6 Press the [END] key several times to exit.

Preventing Uncut Media [OVER CUT/CORNER CUT]

Overlapping the start and end points can prevent the sheet from being left uncut. Configure this setting for very flexible sheets. Setting too large a value will result in cut prints. Perform test cutting and adjust the setting accordingly.

● OVER CUT

The machine cuts the media in front of the cutting start point by the set value. The media is overcut by the set value at the end point.

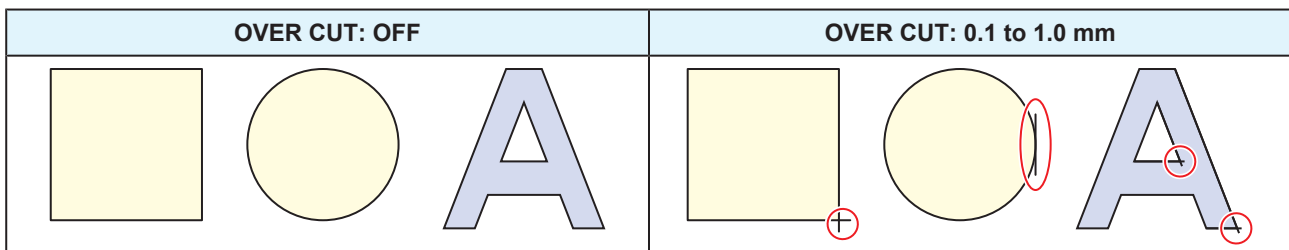

● CORNER CUT

When the OVER CUT setting value is entered, CORNER CUT is displayed. The machine performs over cutting at corners other than the start and end point.

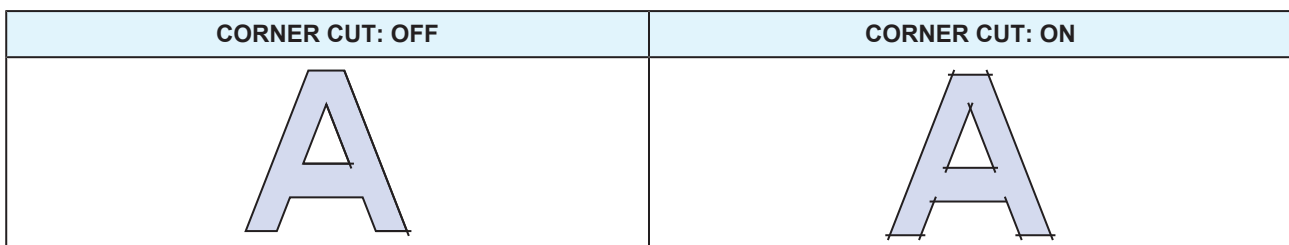

- 1 Press the [FUNCTION] key in local mode.
- 2 Use ▲▼ to select [SET UP], then press the [ENTER/HOLD] key.
- 3 Use ▲▼ to select [OVER CUT], then press the [ENTER/HOLD] key.

- 4** Use ▲▼ to select the [OVER CUT] setting, then press the [ENTER/HOLD] key.
 - Settings: OFF, 0.1 to 1.0 mm (in 0.1 mm increments)
- 5** Use ▲▼ to select the [CORNER CUT] setting, then press the [ENTER/HOLD] key.
 - Settings: ON/OFF
- 6** Press the [END] key several times to exit.

Configuring the Network Settings [NETWORK]



















Sets the network address. The machine must be restarted to enable this setting.

Set the following items:

Item	Setting ^{*1}	Details
IP Address	-	Displays the machine's current IP address. <ul style="list-style-type: none"> • It may take some time to determine the IP address. If the IP address cannot be determined, the display will indicate "0.0.0.0".
MAC Address	-	Displays the machine's current MAC address.
DHCP	<u>ON/OFF</u>	Select "ON" to use the IP address assigned by the DHCP server.
AutoIP	<u>ON/OFF</u>	Select "ON" to use the IP address set by the AutoIP protocol. Note that DHCP takes priority if DHCP is set to "ON".
IP Address	-	Sets the machine's IP address. <ul style="list-style-type: none"> • This can be set when both [DHCP] and [AutoIP] are set to "OFF".
Def.Gateway	-	Sets the machine's gateway. <ul style="list-style-type: none"> • This can be set when both [DHCP] and [AutoIP] are set to "OFF".
DNS Address	-	Sets the machine's DNS server address. <ul style="list-style-type: none"> • This can be set when both [DHCP] and [AutoIP] are set to "OFF".
Sub Net Mask	-	Sets the number of subnet mask digits used by this machine. <ul style="list-style-type: none"> • This can be set when both [DHCP] and [AutoIP] are set to "OFF".

*1. The default settings are shown underlined.

- 1** Press the [FUNCTION] key in local mode.
- 2** Use ▲▼ to select [SET UP], then press the [ENTER/HOLD] key.
- 3** Use ▲▼ to select [NETWORK], then press the [ENTER/HOLD] key twice.
 - The machine's current IP address is displayed. "Info" is displayed at the top right.
 - It may take some time after connecting to the network to determine the IP address. If the IP address cannot be acquired, the display will indicate "0.0.0.0".
- 4** Press the [ENTER/HOLD] key.

- 5** Use   to select [MAC Address], then press the [ENTER/HOLD] key.
 - Displays the machine's current MAC address.
 - Press  to display the next address.
 - 6** Press the [ENTER/HOLD] key.
 - 7** Use   to select [DHCP], then press the [ENTER/HOLD] key.
 - Use   to enable or disable.
 - Select "ON" to use the IP address assigned by the DHCP server.
 - 8** Use   to select [AUTO IP], then press the [ENTER/HOLD] key.
 - Use   to enable or disable.
 - Select "ON" to use the IP address set by the AutoIP protocol. Note that DHCP takes priority if DHCP is set to "ON".
 - 9** If both DHCP and AutoIP are disabled, use   to select the following item, then press the [ENTER/HOLD] key. In all other cases, press the [END] key several times to exit.
 - Setting items: IP Address ("Info" is not displayed at the top right of the display), Def.Gateway, DNS Address, SubNet Mask
 - 10** Use     to alter the setting, then press the [ENTER/HOLD] key.
 - 11** Press the [END] key several times to exit.
-
-  • Turn the power off then on again to update the network settings.

Event Email Function Settings [EVENT MAIL]

An email can be sent to a specified email address when an event (e.g., print start, print end, and abort) occurs.



- SSL (Secure Socket Layer) encoding is not supported.



- Connect the LAN cable to use the event mail function.
 ["Using a LAN Cable"\(P. 33\)](#)

Disclaimers

- Internet communication charges for email notifications, etc. are the responsibility of the customer.
- Event emails may not be delivered if problems arise with the Internet setup or equipment. Mimaki rejects all liability for damages resulting from delivery failure or delay.

● Event email setting item list

Item	Setting ^{*1}	Details
Mail Delivery [Delivery]	ON/OFF	Sets whether event emails are sent.
Select Event [Event]	-	
PlotStart Event	ON/OFF	Sets whether an email is sent when cutting starts.



Item	Setting ^{*1}	Details
Plot End Event	<u>ON/OFF</u>	Sets whether an email is sent when cutting ends.
Error Event	<u>ON/OFF</u>	Sets whether an email is sent when an error occurs.
Warning Event	<u>ON/OFF</u>	Sets whether an email is sent when a warning occurs.
Mail Addr.	Alphanumeric characters or symbols (Not more than 96)	Set the email address to which event emails are to be sent.
Message Subject [Subject]	Alphanumeric characters or symbols (Not more than 8)	Sets the text used as the event email subject.
Server Setup [Server]	-	
SMTP Address	-	Sets the SMTP server.
SMTP Port No.	-	Sets the SMTP port number.
Sender Address [Sender Adr.]	Alphanumeric characters or symbols (Not more than 64)	Sets the email sender address. Depending on the server used, it may not be possible to send emails unless an email address corresponding to the server account is set. <ul style="list-style-type: none"> Setting an email address corresponding to the server account allows emails to be sent.
Authentication [Auth.]	<u>OFF/POP before SMTP/SMTP Auth.</u>	Sets the SMTP server authentication method.
User Name [User Name]	Alphanumeric characters or symbols (Not more than 30)	Sets the user name used for authentication. <ul style="list-style-type: none"> This can be set when [Auth.] is not set to "OFF".
Pass Word	Alphanumeric characters or symbols (Not more than 15)	Sets the password used for authentication. The value currently set is not displayed on the password setting screen. Only a new password can be entered. <ul style="list-style-type: none"> This can be set when [Auth.] is not set to "OFF".
POP3 Addr.	-	Sets the POP server. Set the server name or IP address. <ul style="list-style-type: none"> This can be set when [Auth.] is set to "POP before SMTP".
APOP	<u>ON/OFF</u>	Enables and disables APOP. <ul style="list-style-type: none"> This can be set when [Auth.] is set to "POP before SMTP".
Transmit Test [Test]	-	Sends a test email.

*1. The default settings are shown underlined.

● Enable the event email function.

- 1 Press the [FUNCTION] key in local mode.
- 2 Use ▲▼ to select [SET UP], then press the [ENTER/HOLD] key.
- 3 Use ▲▼ to select [EVENT MAIL], then press the [ENTER/HOLD] key twice.
- 4 Select [ON] on the [Delivery] screen, then press the [ENTER/HOLD] key.

- 5** Press the [END] key several times to exit.
- **Set the event for which event emails are to be sent.**
 - 1** Press the [FUNCTION] key in local mode.
 - 2** Use ▲▼ to select [SET UP], then press the [ENTER/HOLD] key.
 - 3** Use ▲▼ to select [EVENT MAIL], then press the [ENTER/HOLD] key.
 - 4** Use ▲▼ to select [Event], then press the [ENTER/HOLD] key.
 - 5** Use ▲▼ to enable or disable [PlotStart Event], [Plot End Event], [Warning Event], and [Error Event], then press the [ENTER/HOLD] key.
 - For more information on individual events, refer to  "Event email setting item list"(P. 125).
 - 6** Press the [END] key several times to exit.
 - **Set the email address and subject.**
 - 1** Press the [FUNCTION] key in local mode.
 - 2** Use ▲▼ to select [SET UP], then press the [ENTER/HOLD] key.
 - 3** Use ▲▼ to select [EVENT MAIL], then press the [ENTER/HOLD] key.
 - 4** Use ▲▼ to select [Mail Addr.], then press the [ENTER/HOLD] key.
 - The [Mail address] screen is displayed.
 - 5** Use ▲▼◀▶ to set the email address, then press the [ENTER/HOLD] key.
 - Set the email address to which event emails are to be sent.
 - Not exceeding 96 alphanumeric characters or symbols
 - 6** Use ▲▼ to select [Subject], then press the [ENTER/HOLD] key.
 - The [Message subject] screen appears.
 - 7** Use ▲▼◀▶ to set the message subject, then press the [ENTER/HOLD] key.
 - Set the text to be used as the event email subject.
 - Not exceeding 8 alphanumeric characters or symbols
 - 8** Press the [END] key several times to exit.
 - **Set the server.**
 - 1** Press the [FUNCTION] key in local mode.
 - 2** Use ▲▼ to select [SET UP], then press the [ENTER/HOLD] key.
 - 3** Use ▲▼ to select [EVENT MAIL], then press the [ENTER/HOLD] key.

- 4 Use ▲▼ to select [Server], then press the [ENTER/HOLD] key.
- 5 Set [SMTP Addr.], [SMTP Port], [Sender Adr.], and [Auth.], then press the [ENTER/HOLD] key.
 - For more information on the individual items, refer to  "Event email setting item list"(P. 125).
- 6 If "OFF" is selected for [Auth.], press the [END] key several times to exit.
- 7 Set [User Name], [Pass Word], [POP3 Addr.], and [APOP], then press the [ENTER/HOLD] key.
 - For more information on the individual items, refer to  "Event email setting item list"(P. 125).
 - [POP3 Addr.] and [APOP] are displayed when "POP before SMTP" is selected for [Auth.].
- 8 Press the [END] key several times to exit.

Transmit Test

- 1 Press the [FUNCTION] key in local mode.
- 2 Use ▲▼ to select [SET UP], then press the [ENTER/HOLD] key.
- 3 Use ▲▼ to select [EVENT MAIL], then press the [ENTER/HOLD].
- 4 Use ▲▼ to select [Test], then press the [ENTER/HOLD] key.
- 5 Press the [ENTER/HOLD] key on the [EXECUTE] screen.
 - The transmission results are displayed.
 - An error code will be displayed if the test email transmission is unsuccessful. Refer to the error code list and take appropriate action.

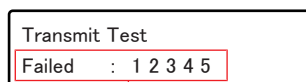

Error code



- Emails may not necessarily be delivered even if they have been sent. Check the terminal receiving the email for spam email filters.
- For more information on server settings or other topics, contact your network administrator or service provider.

- 6 Press the [END] key several times to exit.

● Error Code List

Error code	Likely cause	Corrective action
10	Network connection error	<ul style="list-style-type: none"> • Check to confirm that this machine is connected to a network. • Check the IP address for this machine. • Check if the network setup allows this machine to use DNS.
20	No valid email address	<ul style="list-style-type: none"> • Enter a valid email address.

Error code	Likely cause	Corrective action
11003 11004	No POP server could be found. Or the DNS server could not be accessed.	<ul style="list-style-type: none"> • Check the POP server address. • Check if the network setup allows this machine to use DNS.
11021	Unable to connect to POP server	<ul style="list-style-type: none"> • Check the POP server settings. • Check the firewall settings.
12010	An error was returned from the POP server.	<ul style="list-style-type: none"> • Check the POP server settings.
13000	POP authentication failed.	<ul style="list-style-type: none"> • Check the user name and password. • Check the APOP settings. • Check the authentication method.
10013 10014	No SMTP server could be found. Or the DNS server could not be accessed.	<ul style="list-style-type: none"> • Check the SMTP server address. • Check if the network setup allows this machine to use DNS.
10021	Unable to connect to SMTP server	<ul style="list-style-type: none"> • Check the SMTP server settings. • Check the SMTP port number. • Check the firewall settings.
10*** 11*** 20*** 21***	An error was returned from the SMTP server. Or there was no response.	<ul style="list-style-type: none"> • Check the SMTP server settings. • Communication is not possible with a server that requires SSL communication. • Check the protocol filter settings.
12***	The sender email address is invalid.	<ul style="list-style-type: none"> • Set an email address corresponding to the server account.
13***	The email recipient could be found Or the email address is invalid.	<ul style="list-style-type: none"> • Check the email address. • This error may not always be detected even if the email address is incorrect. • Set an email address corresponding to the server account.
22000 22008	SMTP authentication error	<ul style="list-style-type: none"> • Check the authentication method.
23*** 24*** 25***	SMTP authentication failed.	<ul style="list-style-type: none"> • Check the user name and password.

1. *** is the error code received from the mail server



- If the error persists, wait a while before retrying.

Outputting the Settings List [LIST]

This can be used as a record by the customer or for faxing when inquiring about maintenance.

- 1 Load A4 size leaf sheets orientated in portrait mode, and replace the tool with a pen.**
 - ["Loading a Leaf Sheet \(Cut Sheet\)"\(P. 47\)](#)
 - ["Using a Pen"\(P. 63\)](#)
- 2 Press the [FUNCTION] key in local mode.**

3 Use ▲▼ to select [LIST], then press the [ENTER/HOLD] key.

- The settings list is output.

Important!

- Pressing the [END] key aborts the list output.
Output cannot be resumed from where it was aborted.

Important!

- The list output cannot be edited directly on a computer.
- When loading A4 size paper, align the edges of the pinch rollers with the edges of the paper.

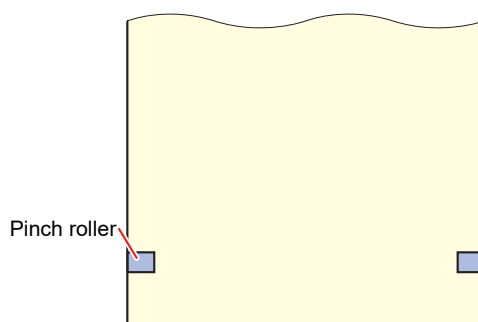

- The list cannot be output if the rotation function has been enabled.
"Error 901: Operation" will be displayed in such cases.
Disable the rotation function before outputting the list.

Copying Settings from Other User Settings [CONFIG COPY]

1 Press the [FUNCTION] key in local mode.**2** Use ▲▼ to select [SET UP], then press the [ENTER/HOLD] key.**3** Use ▲▼ to select [CONFIG COPY], then press the [ENTER/HOLD] key.**4** Use ▲▼ to select the user setting number to be copied, then press the [ENTER/HOLD] key.

- The selected user settings are copied to the current user.
- The settings are retained even when the power is turned off.

5 Press the [END] key several times to exit.

Restoring Default Settings [SETUP RESET]

1 Press the [FUNCTION] key in local mode.**2** Use ▲▼ to select [SET UP], then press the [ENTER/HOLD] key.**3** Use ▲▼ to select [SETUP RESET], then press the [ENTER/HOLD] key.

- The current user settings and parameters are reset.
The other user settings will not be reset.
- The network settings, event email settings, and remote control settings will not be reset.
- The reset settings are retained even when the power is turned off.

4 Press the [END] key several times to exit.

Changing Users [CHANGE USER]

This machine allows settings (cutting conditions, distance correction, and main unit settings) to be saved individually for up to eight users (users 1 to 8). Selecting a user number corresponding to the user allows the configuration to be changed without the need to reset parameters.



- The user cannot be changed while cutting is suspended. Clear the data before changing the user.
- Changing the user invalidates sheet detection. Repeat sheet detection.

- 1 Press the [FUNCTION] key in local mode.
- 2 Use ▲▼ to select [CHANGE USER], then press the [ENTER/HOLD] key.
- 3 Use ▲▼ to select the user number to be displayed, then press the [ENTER/HOLD] key.
- 4 Press the [END] key several times to exit.

Outputting Received Data as ASCII Code [DUMP]

Data can be sent from the host computer and printed as ASCII code. Dumping is possible via an interface to which the host computer is connected.

- 1 Change the tool to a pen.
 - "Using a Pen"(P. 63)
- 2 Press the [FUNCTION] key in local mode.
- 3 Use ▲▼ to select [ASCII DUMP], then press the [ENTER/HOLD] key.



- The dump contents cannot be checked directly on a computer.
- To abort dumping, press the [REMOTE] key to switch to local mode, then clear the data. "Aborting Cutting (Data Clear)"(P. 74)
- When dumping, use sheet detection with rear loading. "Note about sheet detection"(P. 45)

Selecting the Screen Display Language [DISPLAY]

The language displayed on the screen can be selected. (Initially it is set to "English".)

- Available languages:
Japanese, English, German, French, Spanish, Italian, Portuguese, Chinese, Korean, Thai, Russian

- 1 Press the [FUNCTION] key in local mode.
- 2 Use ▲▼ to select [DISPLAY], then press the [ENTER/HOLD] key.
- 3 Use ▲▼ to select the display language, then press the [ENTER/HOLD] key.
- 4 Press the [END] key several times to exit.

Checking Machine Information [INFORMATION]

It is possible to check information relating to the machine.

The following information can be checked:

Item	Details
MODEL	Checks the machine model.
F/W ver.	Checks the machine firmware version.
SERIAL No.	Checks the machine serial number.
IP Address	Checks the machine IP address.
MAIN PCB	Checks the machine PCB name.

- 1** Press the [FUNCTION] key in local mode.
- 2** Use ▲▼ to select [INFORMATION], then press the [ENTER/HOLD] key.
- 3** Use ▲▼ to select the machine information to be displayed, then press the [ENTER/HOLD] key.
 - The corresponding information is displayed.
- 4** Press the [END] key several times to exit.

Chapter 5 Settings













This chapter

This chapter describes the various setting of the [FUNCTION].

5.1 FUNCTION

This features settings for various useful functions and operations when using the machine. Press the [FUNCTION] key and execute or set the following items:

Item	Details	Refer to
Square [SQUARE CUT]	Performs a test cut to confirm that the tool conditions are appropriate. <ul style="list-style-type: none"> Cuts two squares using test cutting. 	 "Test Cutting"(P. 72)
DATA CLEAR	Clears the data when data cutting has been aborted.	 "Aborting Cutting (Data Clear)"(P. 74)
SHEET FEED	Pulls out the sheet before cutting to provide slack. <ul style="list-style-type: none"> Feed length: 0.1 to 51.0 m 	 "Sheet Feed"(P. 120)
Multiple sheet cutting [MULTI COPY]	Cuts multiple copies of the received data. <ul style="list-style-type: none"> Cut copies: 1 to 999 copies Interval between images cut: 0 to 30 mm 	 "Cutting Multiple Copies of the Same Data [MULTI COPY]"(P. 106)
Distance correction [DIST.COMP.]	When cutting long data, discrepancies in the displacement may arise between the sheet left and right sides. This corrects such discrepancies. <ul style="list-style-type: none"> Standard value: <ul style="list-style-type: none"> A direction: 500, 1,000, 1,500, 2,000, 2,500 mm B direction (CG-60AR): 200, 400, 600 mm B direction (CG-100AR): 200, 400, 600, 800, 1,000 mm B direction (CG-130AR): 200, 400, 600, 800, 1,000, 1,200 mm Correction value: <ul style="list-style-type: none"> A direction: $\pm 5\%$ of standard length (0.1 mm steps) B direction: $\pm 5\%$ of standard length (0.1mm steps) Plotting offset: 0 to 300 mm 	 "Length Correction [DIST.COMP.]"(P. 103)
Settings [SET UP]	In this menu, you can make various settings on the machine.	 "SET UP"(P. 135)
MARK sensor	Checks the responsiveness of the register mark sensor when data with register marks was unable to be cut correctly.	 "Checking Register Mark Sensor Responsiveness"(P. 162)
SAMPLE CUT	Cuts a sample to troubleshoot problems when data was unable to be cut correctly.	 "Investigating the Cause of Cutting Failures"(P. 165)
User selection [CHANGE USER]	Settings (cutting conditions, distance correction, and main unit settings) can be saved individually for each user. (Up to 8) Simply selecting a user number corresponding to the user allows the machine to be used without the need to alter any settings.	 "Changing Users [CHANGE USER]"(P. 131)
LIST	This can be used as a record by the customer or for faxing when inquiring about maintenance.	 "Outputting the Settings List [LIST]"(P. 129)

Item	Details	Refer to
ASCII DUMP	Sends data from the host computer, and prints the data as ASCII code.	"Outputting Received Data as ASCII Code [DUMP]" (P. 131)
DISPLAY	Selects the screen display language.	"Selecting the Screen Display Language [DISPLAY]" (P. 131)
Machine information [INFORMATION]	Checks the machine information.	"Checking Machine Information [INFORMATION]" (P. 132)

SET UP







This is used to set various operations to ensure optimal machine performance.





Set using the following procedure:

- 1** Press the [FUNCTION] key in local mode.
- 2** Use to select [SET UP], then press the [ENTER/HOLD] key.
- 3** Use to select an item from the following table, then press the [ENTER/HOLD] key.
- 4** Set the individual items in accordance with the instructions displayed on the screen.
- 5** Press the [END] key several times to exit.

Item	Setting *1	Details
TP DETECT [MARK DETECT]	-	Refer to "Notes on Register Mark Detection Setting Items" (P. 85).
Command selection [COMMAND]	AUTO/MGL-Ilc/MGL-Ic1	Selects the movement units specified by the command. "Command (MGL-Ic1/MGL-Ilc) selection [COMMAND]" (P. 138) <ul style="list-style-type: none"> • AUTO: Selects the command automatically to suit the received data command specifications. • Individual settings: Select to receive data for individual setting commands.
Communication conditions [INTERFACE]	-	Sets computer connection conditions. "Setting the Computer Connection Conditions" (P. 34)
CUT MODE	Standard/High Speed/High Quality [NORMAL/HIGHspd/QUALITY]	Sets the cutting quality. "CUT MODE" (P. 138) <ul style="list-style-type: none"> • Standard: In general, the "NORMAL" setting should be used. • High Speed: This cuts media in a short period of time. Do not use for heavy sheets. • High Quality: This prioritizes cutting quality, and limits the speed to 20 cm/s.
Origin selection [ORGN SELECT]	Center/Lower right [CENTER/Low-R]	Sets the command origin position for the MGL-Ilc command. (The command origin will be "Low-R" for the MGL-Ic1 command.) "Origin selection [ORGN SELECT]" (P. 139)

Item	Setting *1	Details
		<ul style="list-style-type: none"> • CENTER: Sets the command origin in the center of the available cutting area. • Low-R: Sets the command origin at the lower right of the available cutting area.
EXPANDS	ON/OFF	Reduces dead space to expand the cutting (printing) area. ☞ "Expanding the Cutting Area [EXPANDS]"(P. 108)
Rotation [ROTATION]	ON/OFF	Selects the cutting movement direction. ☞ "Selecting the Cutting Movement Direction [ROTATION]"(P. 109)
BUZZER	ON/OFF	It is possible to mute key sounds and error sounds. Setting to "OFF" also mutes the register mark sensor response sound. ☞ "Checking Register Mark Sensor Responsiveness"(P. 162)
Divided cutting [DIVISIONcut]	OFF/Y/X	Sets divided cutting. ☞ "Divided Cutting [DIVISIONcut]"(P. 111)
Priority [PRIORITY]	HOST/PANEL	Sets which settings take priority if the machine and the host computer are set differently. (For MGL-IIc only) ☞ "Priority"(P. 139) <ul style="list-style-type: none"> • HOST: The host computer settings take priority. • PANEL: The machine settings take priority.
Size response value [DISTANCE]	1 to <u>51</u> m	Sets the maximum response value for the available area reading command from the host computer. (MGL-Ic1 only) ☞ "Size response value"(P. 139)
SHEET sensor	ON/OFF	Detects whether a sheet is present and sheet length. ☞ "SHEET sensor"(P. 139)
UP SPEED	-	
UP SPEED X	AUTO / 5, 10, 20, 30, 40, 50, 60, 70, <u>73</u> cm / s	Sets the sheet and carriage movement speed while the tool is raised. Setting a slower speed can reduce sheet offsets in the feed direction.
UP SPEED Y	AUTO / 5, 10, 20, 30, 40, 50, 60, 70, 80, 90, <u>100</u> cm / s	Setting to "AUTO" uses the SPEED value set in the tool conditions as the up speed.
JOG STEP	<ul style="list-style-type: none"> • mm setting 0.1 mm, <u>1.0</u> mm • inch setting 1/16 inch, 1/254 inch 	Sets the amount of movement when using the jog keys to move the carriage and sheet. Example: 0.1 mm: Moves 0.1 mm each time a jog key is pressed. ☞ "JOG STEP"(P. 140)
MM/INCH	<u>mm</u> /inch	Selects the length units displayed.
FEED OPTION	-	☞ "Feed Settings [FEED OPTION]"(P. 121)
DUMMY CUT [DUMMY CUT]	ON/OFF	When enabled, the cutting blade makes a dummy cut in one direction before starting cutting. Dummy cutting is performed each time the tool or cutting conditions are altered. ☞ "DUMMY CUT"(P. 140)
SHEET TYPE [SHEET TYPE]	<u>STANDARD</u> ;/HEAVY	Sets the weight of the sheet to be loaded. ☞ "SHEET TYPE"(P. 140)

Item	Setting *1	Details
		<ul style="list-style-type: none"> • STANDARD: When using regular sheets • HEAVY: When using heavier sheets (The maximum cutting speed setting will be limited to 20 cm/s, and the tool will be moved at 20 cm/s even if the up speed is set to a value over 20 cm/s.)
SORTING	ON/OFF	<p>Sets whether to alter the cutting sequence before cutting.</p> <p> "Changing the Cutting Sequence [SORTING]"(P. 116)</p>
ADJ-PRS OFFSET [ADJ-PRS OFS]	-9 to <u>0</u> to 9	<p>When cutting the corners, the pressure is automatically decreased (by about 5 g) to prevent the sheet from lifting up. As a result, the cutting blade might not rotate smoothly and may leave uncut parts. Adjust the pressure for cutting the corners if they are left uncut.</p> <p>(Approx. -30 g to 30 g)</p> <p> "ADJ-PRS OFFSET"(P. 140)</p>
PINCH ROLL	-	 "Setting the Number of Pinch Rollers to Use"(P. 56)
OVER CUT	OFF/0.1 to 1.0 mm	<p>Overlapping the start and end points prevents the sheet from being left uncut.</p> <p> "Preventing Uncut Media [OVER CUT/CORNER CUT]"(P. 123)</p>
CORNER CUT	ON/OFF	<p>The machine performs over cutting at corners other than the start and end point.</p> <p> "Preventing Uncut Media [OVER CUT/CORNER CUT]"(P. 123)</p>
Start mode [START MODE]	LOCAL/REMOTE	<p>Sets the mode after sheet detection.</p> <ul style="list-style-type: none"> • LOCAL: The machine waits in local mode after sheet detection. • REMOTE: The machine automatically switches to remote mode after sheet detection.
Pressure correction [PRESS COMP.]	ON/OFF	Corrects any variations in cutting pressure depending on location to unify the cutting performance.
Register mark search [SEARCH MARK]	ON/OFF	<p>Set the automatic register mark search function after sheet detection.</p> <p> "Detecting Register Marks Automatically After Sheet Detection"(P. 95)</p>
Pen setting [PEN SETTING]	-	-
Down Speed	0 to <u>20</u> to 64	<p>Sets the pen down speed. Increasing the setting increases the speed.</p> <p>When cutting heavy sheets 1 mm or more thick, the pen nib may be dragged if the down speed is too fast. In such cases, the down speed should be set to a value not greater than 20.</p>
CURVE MODE	FAST/SLOW	Sets the cutting speed for curved lines.

Item	Setting ^{*1}	Details
		If curved cutting lines become crooked, set to "SLOW" to reduce the cutting speed on curved line segments.
Up height [UP HIGHT]	<u>50%</u> , 75%, 100%	Sets the height when the tool is raised. The height to which the tool is raised from the down position is specified as a percentage of the approximate stroke. A smaller height setting allows faster cutting. Set a larger up height in cases where there is a risk of the cutter blade damaging the sheet due to the thickness of the sheet or the sheet lifting up.
NETWORK	-	Sets the network address. The machine must be restarted to enable this setting.  "Configuring the Network Settings [NETWORK]"(P. 124)
EVENT MAIL	-	An email can be sent to a specified email address when an event (e.g., cutting start, cutting end, and abort) occurs. The machine must be restarted to enable this setting.  "Event Email Function Settings [EVENT MAIL]"(P. 125)
R.CONTRL	-	Enabling remote control allows the machine to be operated remotely using Mimaki Remote Access without having to use the operating panel on the machine.  "Operating the Main Unit Panel Remotely [R.CONTRL]"(P. 118)
Copy settings [CONFIG COPY]	-	Copies settings to the settings of another user.  "Copying Settings from Other User Settings [CONFIG COPY]"(P. 130)
Setup Reset [SETUP RESET.]	-	Resets the details set.  "Restoring Default Settings [SETUP RESET]"(P. 130)

*1. The default settings are shown underlined.

● Command (MGL-Ic1/MGL-IIc) selection [COMMAND]

- Altering the command using [COMMAND] clears the receive buffer contents.
- When set to "AUTO", correct cutting results may not be achieved with large data sizes, for example. If this occurs, change the setting to the command name (MGL-Ic1 or MGL-IIc).
- When set to "AUTO", cutting starts using the command detected by the machine once data has been received from the computer. If [ERROR 16 AUTO I/F] appears after data has been received, this indicates automatic detection failed.
If this occurs, set the command name (MGL-Ic1 or MGL-IIc) allowing correct cutting.
- The command automatically detected in "AUTO" remains effective until data is cleared  ["Aborting Cutting \(Data Clear\)"\(P. 74\)](#) or the sheet is reloaded.

● CUT MODE

Select "High Quality" when cutting the following data:

- 10 mm characters or smaller
- Data containing many sharp edges
- Fine cutting data This involves a risk of jagged cut lines if data is overly complex. In such cases, the lines can be smoothed by changing the setting to "HIGHspd".

● Origin selection [ORGN SELECT]

The origin position will be as follows when the rotation function is enabled:

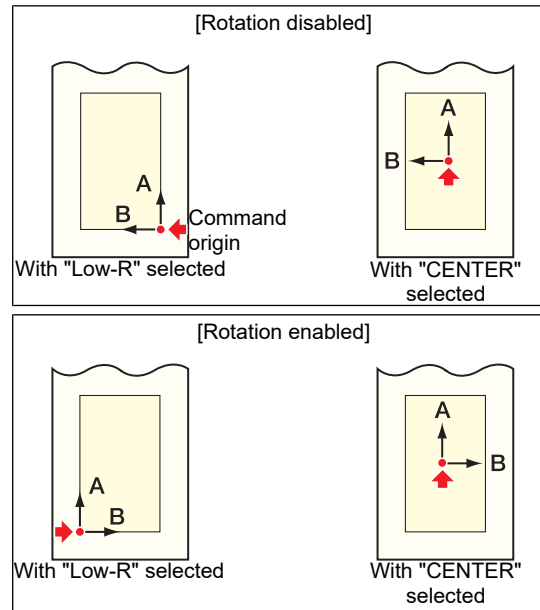

- Setting the command origin to "Low-R" when using roll sheet expands the cutting area to up to 51 m.
- Setting the command origin to "CENTER" when using roll sheet gives a cutting area of 5 m.

● Priority

The priority setting is enabled when using the MGL-IIc command. It covers the following items:

Pen selection command	SP;
Pen down movement speed setting command	VS;
Pen up movement speed setting command	ZA;
Acceleration setting command	AS;
Pen pressure setting command	FS;, ZF;
Cutting blade correction setting command	ZO;

● Size response value

The value set for size response value is the maximum response size to be sent to the host computer. The actual available cutting error will not be changed.

If the sheet detection size is smaller than [DISTANCE], the detection size will form the response value.

● SHEET sensor

It may not be possible to detect sheets when using transparent sheets or sheets with a black underside, resulting in an error message appearing.

If this occurs, disabling the sheet sensor function disables sheet detection and enables cutting.

- Be sure to set the cutting area if the sheet sensor function is disabled. ["Cut Area Setting \[CUT AREA\]"](#)(P. 101) Cutting may continue even if data protrudes beyond the sheet and the sheet ends.

● JOG STEP

Jog step should be set to determine an accurate position in the following cases:

- When using two-point line correction (☞ "2-Point Line Correction [AXIS CORRECT]"(P. 100))
- When setting an origin at an accurate position

● DUMMY CUT

Dummy cutting will not be performed if "PEN" or "CRE" (☞ "Using the Creasing Tool"(P. 67)) is selected in the tool conditions.

It will be performed in front of the pinch roller nearest to both sides from the current carriage location.

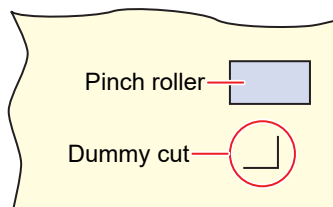

The default dummy cut setting is "ON".

Set to "OFF" when cutting cut-out characters or to avoid damaging the sheet.

When set to "OFF", performing test cutting allows the direction of the cutting blade to be adjusted. (☞ "Test Cutting"(P. 72))

● SHEET TYPE

Cutting (or printing) at high speed on heavy or wide sheets may cause the sheet to become offset. It may also cause "Error 401: Motor Alarm" to occur. If this occurs, set the sheet setting to "HEAVY".

● ADJ-PRS OFFSET

Uncut sections may remain at cut sections where the angle is 120° or less due to light pressure when the cutter is lowered to the sheet, such as when using the optional eccentric blade.

This is because the cutting pressure is automatically decreased (below approximately 5 g) to prevent the sheet from lifting up when cutting at corners. The low cutting pressure prevents the cutting blade from rotating smoothly in the direction of travel, leaving uncut sections. In cases like this, the pressure (correction pressure offset) should be increased when cutting at corners. If the pressure is too high, causing the joints between line segments to become too prominent, the pressure can be reduced to make these less prominent.

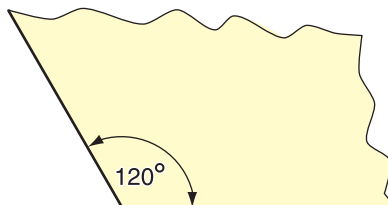

Chapter 6 Maintenance



This chapter

To ensure years of precise performance, maintain the machine periodically based on frequency of use.

Read the maintenance precautions thoroughly before maintaining this product.

Maintenance Precautions	142	Consumable Item Replacement	147
Maintenance Items and Timing	143	Cutter Replacement	147
Items Required for Maintenance	143	Pinch Roller Replacement	147
Maintenance Procedure	144	Pen Line Rubber Replacement	148
Cover (Exterior) Cleaning	144		
Cleaning the Y-Bar Rail Surfaces	145		
Cleaning the Grit Rollers	146		
Cleaning the Pinch Rollers	146		
When Not in Use for Extended Periods ...	146		

6.1 Maintenance Precautions



- This machine includes parts that must be replaced periodically. We therefore recommend taking out a maintenance contract. Carry out maintenance periodically and replace consumable items to prevent quality defects and accidents.

WARNING



- Clean periodically. Debris and dust will accumulate on electrical components when the machine is used for extended periods. There is a risk of failure, electric shock, or fire due to current leakage.
- Do not clean by blowing—e.g., avoid using air blowers. Doing so may lead to failure, electric shock, or fire involving the machine if airborne debris or dust gets inside electrical components. Wipe using a soft cloth soaked in diluted neutral detergent and thoroughly wrung out. A vacuum cleaner may also be used for cleaning.



- Do not allow liquids to get inside the machine. Otherwise there is a risk of failure, electric shock, or fire.

CAUTION



- For heavy soiling, wipe using a soft cloth soaked in diluted neutral detergent and thoroughly wrung out.



- Do not use chemical products containing benzene, thinner, or abrasives. Use of these chemicals may result in damage to or deformation of parts.
- Do not use chlorine-based detergents. Doing so may corrode the machine.

6.2 Maintenance Items and Timing

Timing	Item
Before starting work	Cleaning the Y-Bar Rail Surfaces  "Cleaning the Y-Bar Rail Surfaces"(P. 145)
When dirty	Cleaning the Grit Rollers  "Cleaning the Grit Rollers"(P. 146)
	Cleaning the Pinch Rollers  "Cleaning the Pinch Rollers"(P. 146)
	Cover (Exterior) Cleaning  "Cover (Exterior) Cleaning"(P. 144)
When the cutting blade becomes chipped or blunt	Cutter Replacement  "Cutter Replacement"(P. 147)
When the pinch rollers become worn or cannot be cleaned	Pinch Roller Replacement  "Pinch Roller Replacement"(P. 147)
When the pen line rubber is excessively damaged, deformed, worn, or lifting, and when cutting quality has deteriorated	Pen Line Rubber Replacement  "Pen Line Rubber Replacement"(P. 148)
When the machine is not to be used for extended periods	<ul style="list-style-type: none"> • Do not leave sheets loaded. • Push the clamp lever to the rear.  "When Not in Use for Extended Periods"(P. 146)

Items Required for Maintenance

To order replacement consumable items, contact your local dealer or our service office. For more information on consumable items, refer to our website. <https://mimaki.com/supply/cutting.html>



- Avoid storing this product in locations accessible to children.

6.3 Maintenance Procedure

Cover (Exterior) Cleaning



- Do not allow liquids to get inside the machine. Otherwise there is a risk of failure, electric shock, or fire.

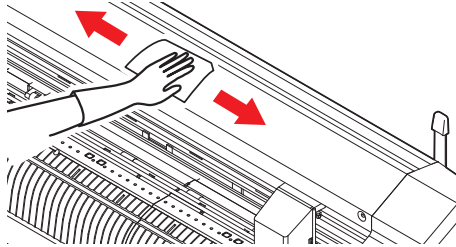

- For heavy soiling, wipe using a soft cloth soaked in diluted neutral detergent and thoroughly wrung out.

Cleaning the Y-Bar Rail Surfaces

Important!

- Before use, be sure to gently wipe the four rail faces A to D shown in the following figure with a dry cloth to remove any dirt or dust. Dirt on the rails may cause abnormal noise and affect cutting quality.

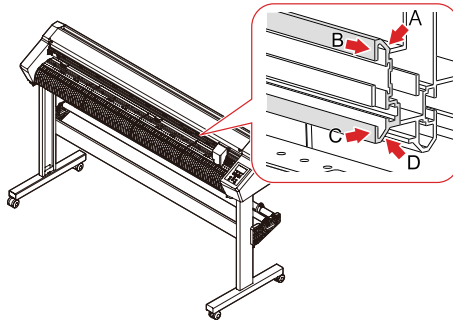

A: Upper rail rear



B: Upper rail side



C: Lower rail side



D: Lower rail rear



Cleaning the Grit Rollers

With use, the protrusions on the grit rollers may become clogged with paper dust from sheets, causing sheets to slip.

To prevent this, visually check for any debris, and clean promptly.

A brush (such as a toothbrush) should be used to clean the grit rollers.

Use a small amount of alcohol if dirt is difficult to remove.

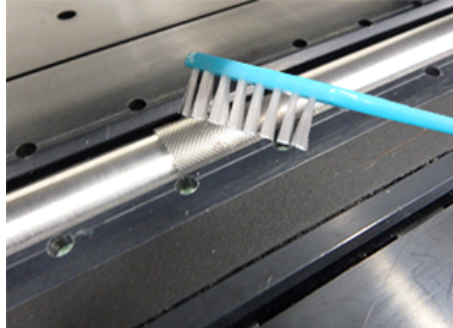

Cleaning the Pinch Rollers

Leaving debris on the pinch rollers may cause it to build up and harden.

To prevent this, wipe clean using a dry cloth or cloth moistened with alcohol.



When Not in Use for Extended Periods

Clean as follows if the product is not used for one week or longer:



- Do not leave with sheets loaded on the platen. This may create irregularities or ripples in the sheet.



- When this machine is not in use, push the clamp lever to the rear to separate the pinch rollers from the grit rollers. Leaving the pinch rollers in the lowered position for an extended period of time may cause the pinch rollers to become deformed. Deformation of the pinch rollers may prevent the sheet from being fed correctly.

6.4 Consumable Item Replacement

To order replacement consumable items, contact your local dealer or our service office.

For more information on consumable items, refer to our website.

<https://mimaki.com/supply/cutting.html>



- When disposing of the product, contact an industrial waste disposal operator or dispose of the product in accordance with the local laws and regulations.



- Avoid storing this product in locations accessible to children.

Cutter Replacement

Replace cutters when blades are chipped or blunt.



- Avoid touching the cutter blade. Failure to do so may result in injury.
- Do not shake or swing the cutter holder. Doing so may cause the blade to come off.



- When disposing of the product, contact an industrial waste disposal operator or dispose of the product in accordance with the local laws and regulations.

1 Rotate the adjusting knob to extend the cutter blade fully.

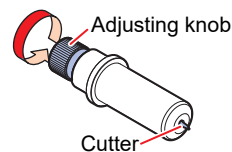

2 Use tweezers to pull out the cutter.



- If the blade is chipped and difficult to remove using tweezers, remove the black cover to facilitate replacement. Take care not to injure yourself by handling the blade directly and to avoid dropping it.

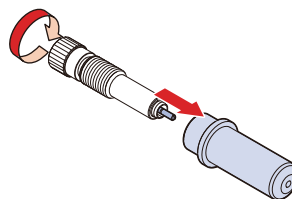

3 Insert a new cutter into the cutter holder using tweezers.

- Check the orientation of the cutter before inserting it fully.

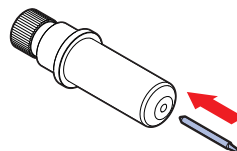

Pinch Roller Replacement

Replace worn or dirty pinch rollers with new ones.

The pinch roller replacement kit (SPC-0746) contains the following parts:

Part name	Quantity	Note
Pinch roller	1	
Retaining screw	2	Not used during replacement.
Curved E-ring	1	Not used during replacement.
E-ring	1	Not used during replacement.
O-ring	2	
Washer	2	Not used during replacement.

● Recommended replacement guide

Replace the pinch rollers every month if used for approximately 12 hours per day.

Replace the pinch rollers every two weeks if used 24 hours per day.

- 1** Turn off the power to the plotter, then push back the clamp lever to raise the pinch rollers.
- 2** Lay paper beneath the pinch rollers.
 - Lay paper to avoid dropping parts between the gaps.
- 3** Remove the O-rings, pull out the P/R spindle horizontally, then detach the pinch roller.
 - Do not lose the O-rings.
 - The spindle may be difficult to pull out or reinsert.
- 4** Insert the P/R spindle into the new pinch roller, then reattach the O-rings.

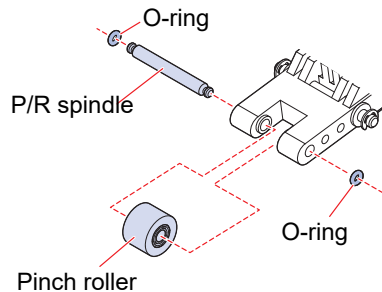

Pen Line Rubber Replacement

The pen line rubber forms the surface over which pen plotting, cutting, and creasing are performed.

Replace when the pen line rubber is excessively damaged, deformed, worn, or lifting, and when cutting quality has deteriorated.

- 1 Use tweezers to peel off the end of the pen line rubber.**
 - Wipe off any adhesive remaining in the platen slot with alcohol.

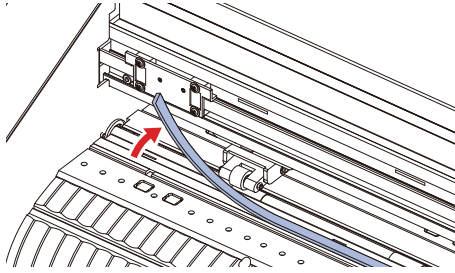

- 2 Attach the double-sided tape provided into the platen slot.**
- 3 Peel off the backing paper from the double-sided tape.**
- 4 Attach a new pen line rubber on top of the double-sided tape.**
 - Make sure the pen line rubber is laid flat.

Chapter 7 Options



This chapter

Describes the various options.

Sheet Tables and Cutting Sheet	152
Attaching the Sheet Tables	152
Loading a Sheet on the Cutting Sheet	153

Cutting.....	154
Storing the Cutting Sheet.....	157

7.1 Sheet Tables and Cutting Sheet

The sheet tables are attached to the machine as shown below and used to support the cutting sheet. The explanation here uses illustrations of the CG-60AR.

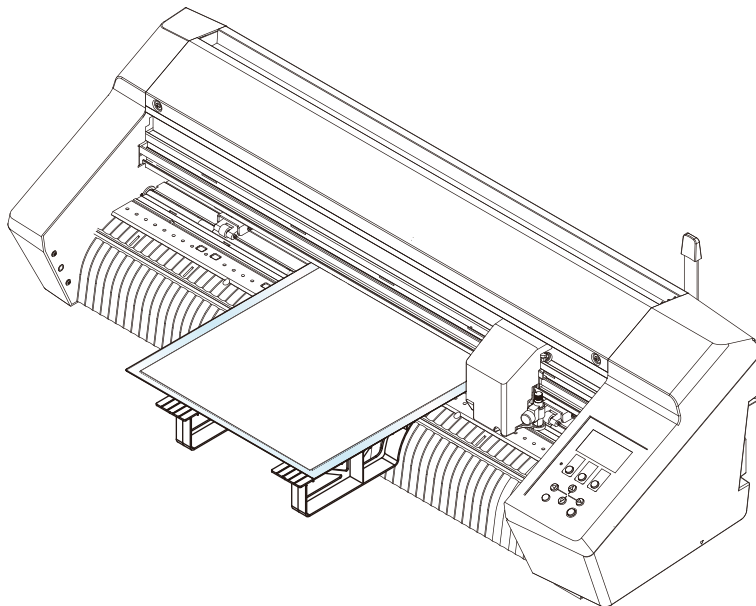

The cutting sheet allows cutting and creasing on coated card (thin to medium thickness coated card recommended) and all types of cutting on various types of sheet.  ["Using the Creasing Tool"\(P. 67\)](#)



- Peel sheets off the cutting sheet slowly and carefully. Thinner sheets may not peel off so cleanly. Affix a small part of the sheet to the cutting sheet to check whether it can be peeled off cleanly before use.
- Pay attention to the following details. Failure to observe these precautions may prevent correct cutting, creasing, or register mark detection.
Recommendations for coated card: Thickness not exceeding 0.6 mm, weight not exceeding 450 g/m²
 - (1) The cutting sheet can be used multiple times. After use, place the cutting sheet in a bag, and store away from direct sunlight.
As a guide, the cutting sheet should be replaced after approximately ten uses. If the cutting sheet adhesion has deteriorated or the sheet is warped, it should be replaced even if it has been used fewer than ten times.
 - (2) Coated card cannot be cut using the blade provided as standard. The "SPB-0092" cutter for heavy paper sold separately should be used.
 - (3) With thick coated card, there is a risk of reduced cutting quality and precision.
 - (4) Curled sheets must be uncurled before use.
 - (5) When affixing a sheet to the cutting sheet, make sure it is not lifting or detaching. Ensure the sheet does not protrude beyond the adhesive surface.
 - (6) Do not use sheets larger than A3 size (297 mm x 420 mm) or smaller than 100 mm x 148 mm.

Attaching the Sheet Tables

Attach the four sheet tables at the front and rear of the machine.

- 1 Affix the provided mark stickers at the locations of the two recesses on the front for inserting the sheet tables.**
 - Affix the mark stickers at the third and fifth recesses from the right.

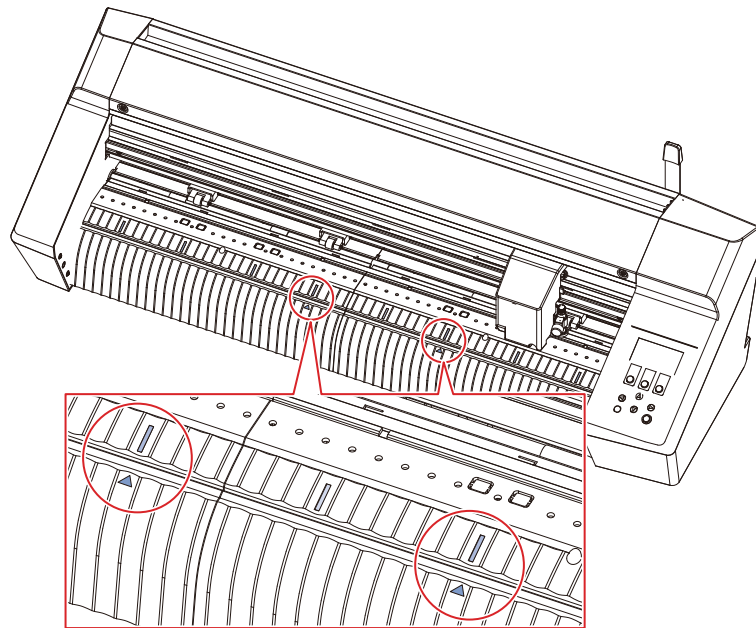

- 2 Affix the provided mark stickers at the locations of the two recesses on the rear for inserting the sheet tables.**

- Affix the mark stickers at the third and fifth recesses from the left when viewing from the rear.

- 3 Attach the two sheet tables to the recesses at the front.**

- Insert the lugs on the sheet tables into the recesses on which the mark stickers are affixed.

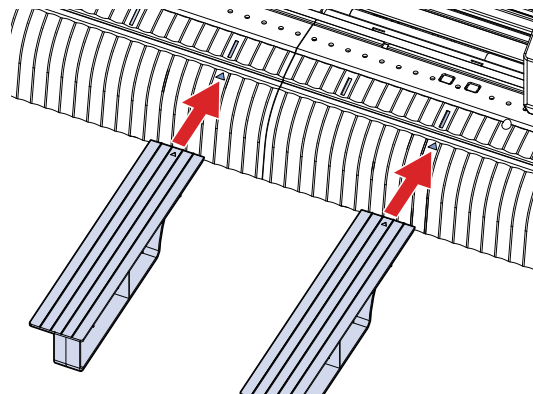

- 4 Attach the two sheet tables to the recesses at the rear.**

- Insert the lugs on the sheet tables into the recesses on which the mark stickers are affixed.

Loading a Sheet on the Cutting Sheet

- 1 Remove the cutting sheet sandwiched between the reinforcing card from its bag.**



- Retain the reinforcing card and bag, as these will be used when storing the cutting sheet.

- 2 Peel off the separator (adhesive surface protector) from the cutting sheet.**



- Take care not to touch the adhesive surface.
- Retain the separator, as this will be used when storing the cutting sheet.

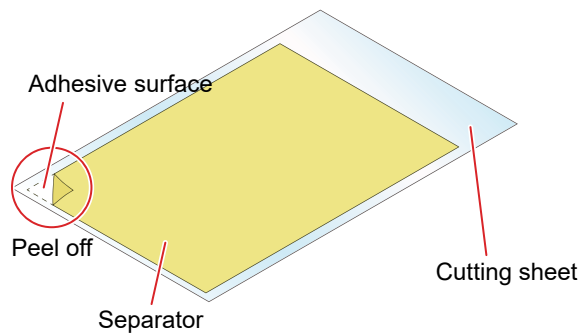

3 Affix the sheet to the adhesive surface of the cutting sheet.

- The size of the adhesive surface corresponds to the available cutting area. Affix the sheet so that it is within the available cutting area.



- When affixing thin sheets, take care to ensure that the sheet does not wrinkle.
- Coated card must be affixed with the non-coated side against the adhesive surface. The card may become detached if the coated side is affixed or both sides of the card are coated.

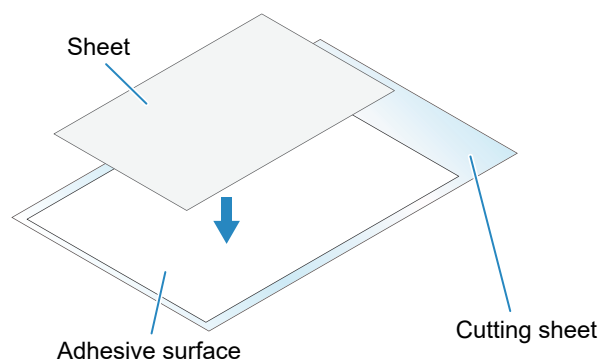

Cutting

Always use three pinch rollers. The middle pinch roller helps to prevent the sheet lifting up.

["Setting the Number of Pinch Rollers to Use"\(P. 56\)](#) ["Enabling and Disabling the center clamp"\(P. 57\)](#)

1 Move the three pinch rollers respectively to the positions of the grit rollers shown in the figure below.

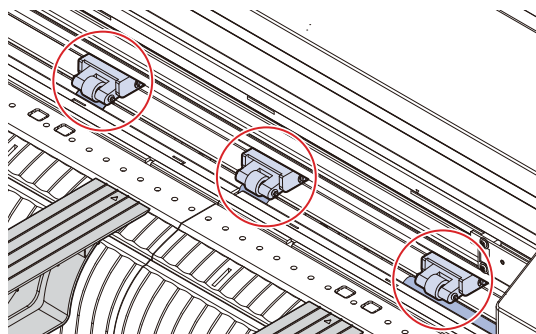

2 Push back the clamp lever to raise the pinch rollers.

3 Place the cutting sheet on top of the sheet tables, and pass it through to the platen.

- Insert into the gap between the pinch rollers and the grid rollers.
- Note the insertion direction of the cutting sheet.

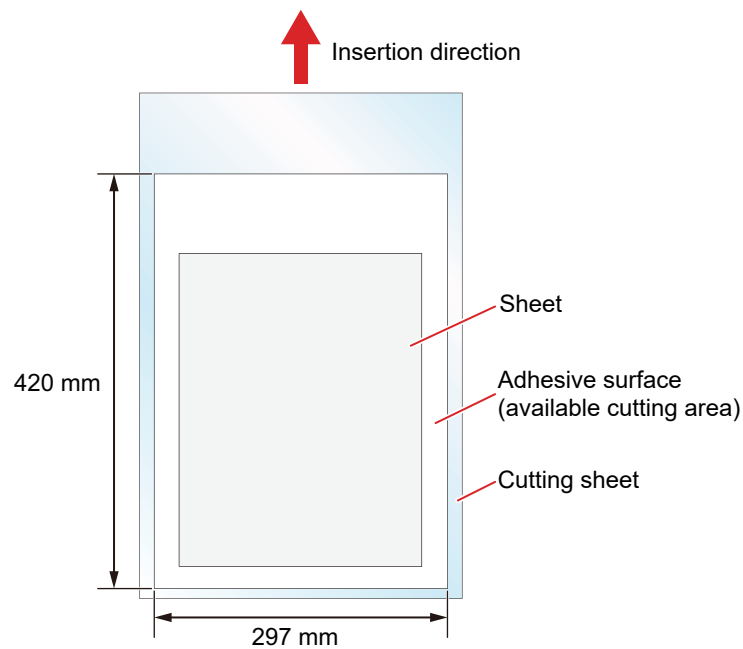
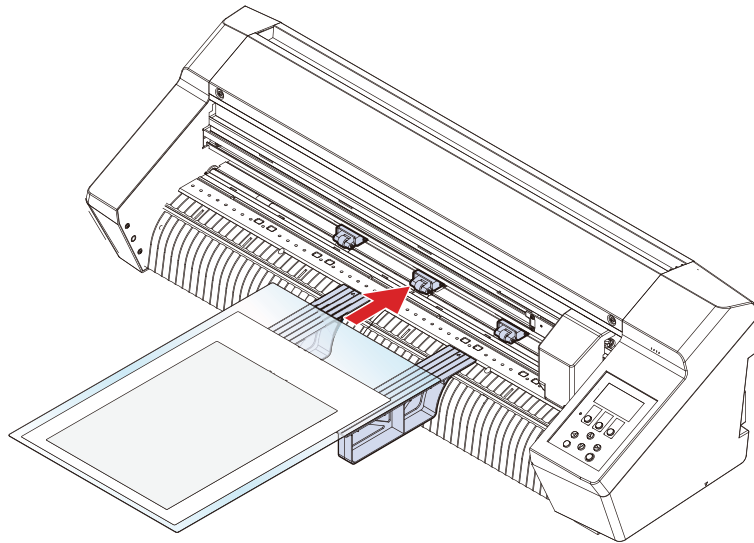

4 Move the cutting sheet so that the left pinch roller is positioned as shown in the following figure. Move the right pinch roller to match the cutting sheet.

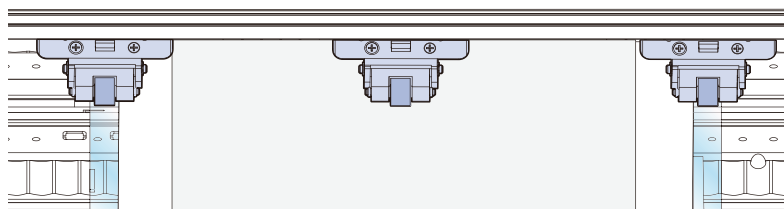



- Cutting and creasing will not be possible correctly in the following cases:

Incorrect examples

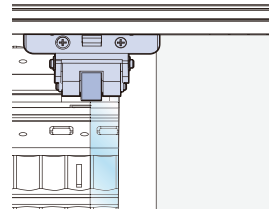

Pinch roller riding over cutting sheet edge

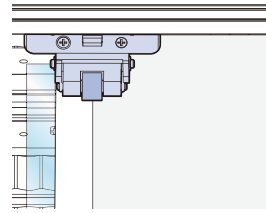

Pinch roller riding over sheet edge

- 5** Align the front of the cutting sheet with the straight line at the front of the machine as shown in the figure below.

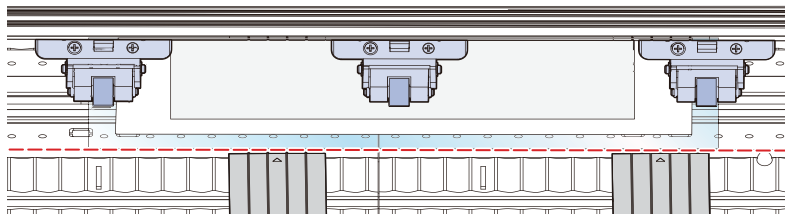

- 6** The middle pinch roller should be used, selecting High mode/Low mode or enabling/disabling the center clamp to suit the sheet being used.

- ["Setting the Clamp High/Low Mode"\(P. 57\)](#) ["Enabling and Disabling the center clamp"\(P. 57\)](#)
- The center clamp should be enabled (center clamp up) if you do not wish leave pinch roller marks on the sheet.

- 7** Pull the clamp lever toward you to lower the pinch rollers and clamp the cutting sheet.

- Check the following points before clamping the cutting sheet:
 - Check that the cutting sheet is not at an angle.
 - Check that the pinch rollers are correctly positioned.

- 8** For information on the cutting procedure, refer to the cutting process.

- ["Cutting Process"\(P. 42\)](#), ["Process for Cutting Data with Register Marks"\(P. 78\)](#)



- Using [Read sheet] in FineCut/Coat9 reads in the size of the cutting sheet. Be sure to set the origin on the sheet on the machine before using [Read sheet] in FineCut/Coat9. Next, check to confirm that the cutting data fits within the sheet size before starting plotting.

- 9** Peel the sheet off the cutting sheet.



- Peel the sheet off slowly and carefully.
- When peeling off thin sheets, take care not to tear the sheet or leave parts attached to the adhesive surface.

● Guideline Cutting and Creasing Condition List for Coated Card

The conditions listed here are only guidelines and do not guarantee quality.

Cutting quality may be reduced and the blade may become worn more quickly if conditions outside these ranges are used.

Method for changing the up height and sheet settings:  "SET UP"(P. 135)

Type	Function	Weight	Tool	Blade protrusion length	Pressure	Speed	Offset	Up height	SHEET TYPE
Coated card	Cut	310 g/m ² (Thickness 0.4 mm)	SPB-0092 Cutter for Heavy paper	0.6 mm	300 g	20 cm/s	0.75 mm	100 %	HEAVY
		450 g/m ² (Thickness 0.6 mm)		0.8 mm	400 g	20 cm/s	0.75mm	100 %	HEAVY
	Crease	-	OPT-C0243 Creasing tool	-	500g	5 cm/s	-	100 %	HEAVY

Storing the Cutting Sheet

- 1** Affix the separator to the adhesive surface of the cutting sheet, sandwich it between the reinforcing card, then place it in its bag for storage.
 - Store away from high temperatures and direct sunlight.
- 2** Detach the sheet tables.

Chapter 8 Troubleshooting



This chapter

This chapter describes procedures for troubleshooting and addressing messages on the display.







Troubleshooting.....	160	Investigating the Cause of Cutting Failures165
Checking Register Mark Sensor			
Responsiveness.....	162	Problems Indicated by Messages	167
Aligning the Register Mark Sensor Position		Error Messages.....	167
.....	164	Display Message List.....	170





8.1 Troubleshooting

For information on troubleshooting, refer to this chapter. Refer to the following URL for frequently asked questions (FAQs) about this product and customer support videos.

<https://mimaki.com/support/>

If the recommended corrective action does not resolve the problem, contact your local dealer or our service office.

Symptom	Cause	Corrective action
The power does not turn on.	The machine is not connected to the power outlet by the power cable.	Insert the power plug securely into the power outlet.  "Connecting the Power Cable" (P. 36)
	The power cable provided is not being used.	Use the power cable provided.
	The power is not turned on.	Turn the power on.  "Turning On the Power" (P. 38)
Cutting (printing) is not possible.	Parameters such as the plotter name are incorrectly set in the application.	Check the application settings.
	The interface cable is not correctly connected.	Connect the interface cable correctly.  "Connect host computer to machine." (P. 33)
	The USB driver has not been installed.	Install the USB driver using the FineCut/Coat9 installer.
	Unidentified cause.	Cut a sample stored in the machine to identify the cause. Executing a sample cut will clear any data saved in the receive buffer.  "Investigating the Cause of Cutting Failures" (P. 165)
An error occurs when data is sent from the computer.	The command is incorrectly set	Adjust the command settings between the application and plotter.
	The plotter model is incorrectly set in the application.	Set the plotter model to [CG-AR] in the application.
Sheet detection is not possible.	A transparent sheet or sheet with black underside is being used.	Disable the sheet sensor function.  "SHEET sensor" (P. 139)
Cutting forms a broken line.	The tool holder knob is loose.	Retighten the knob on the tool holder.
	The cutting blade is protruding too far.	Adjust the cutting blade protrusion appropriately.
	Half cut is enabled.	Disable half cut in the tool conditions.
	The cutting blade is chipped or worn.	Replace with a new cutter.  "Cutter Replacement" (P. 147)
	The cutting blade does not rotate smoothly.	Replace with a new holder.
The cut length differs from the data length.	The sheet feed length changes depending on the sheet thickness.	Perform distance correction to correct the discrepancy.  "Length Correction [DIST.COMP.]" (P. 103)
Offset occurs during cutting.	The pinch rollers and grit rollers are not gripping the sheet firmly.	Check the pinch roller and grit roller positions to ensure that the sheet is gripped securely.

Symptom	Cause	Corrective action
	The clamping force (High/Low mode) has not been correctly selected.	Select the correct clamping force.  "Clamp"(P. 28)
	The roll sheet is loosely wound with slack present, causing the sheet to meander or become skewed when fed.	When loading the roll sheet, adjust the roll slack and parallel of the roll edges before feeding the sheet.
	The sheet is folded, detached from the backing sheet, with air bubbles trapped inside.	Take care to ensure that the sheet does not become folded and is not subjected to any load during sheet feeding or cutting when cutting long data.
		Allow sufficient work space in the sheet feed direction when cutting long data. (At least 1.5 m at both front and rear)
	The sheet loading direction (front or rear) does not match the data output direction.	Make sure the directions match.
	The sheet touches the floor.	Reduce the cutting speed (SPEED) to reduce the load when the sheet touches the floor.
The cutting position is offset when cutting using register marks.	The side margins for the pinch rollers are insufficient.	Allow side margins of at least 20 mm for the pinch rollers.
	There is a problem with the register marks.	Perform the operation used to check the responsiveness of the register mark sensor.  "Checking Register Mark Sensor Responsiveness"(P. 162)
The tool is dragged during operation and excessive cutter marks remain on the sheet.	The cutter and register mark sensor offset values may be offset.	Adjust the register mark sensor positions.  "Aligning the Register Mark Sensor Position"(P. 164)
	The sheet is warped.	Load the sheet to prevent it from warping.
	A curled sheet is being used.	Do not use curled sheets or sheets with folded ends.
	The sheet has ripples/surface irregularities or is lifting up.	If you are using roll sheet, use a smooth section of the sheet for initial feeding.
	Tool raising/lowering is faulty.	Turn off the power, then check to confirm whether the tool holder can be raised/lowered manually. If the tool holder remains down and cannot be raised, contact your local distributor.
Uncut sections remain.	Excessively thick sheet is being used.	Use sheet within the specified range. Alter the [UP HIGHT] setting.  "SET UP"(P. 135)
	The pressure for lowering the cutter is too low.	Increase the [ADJ-PRS OFS] value. Increase the cutter pressure and check.  "Test Cutting"(P. 72) Check if [PRESS COMP.] is enabled.

Checking Register Mark Sensor Responsiveness



- Responsiveness cannot be checked accurately by moving the head and sheet manually. Be sure to check the register mark sensor responsiveness using the following procedure:
- For information on creating register marks, refer to ["Creating Register Marks"\(P. 80\)](#).
- The pointer offset set using this operation will not be reset by [SETUP RESET].
- Enable the buzzer sound. (["SET UP"\(P. 135\)](#) > [BUZZER]) The detection confirmation sound will not sound if the buzzer sound is disabled.

- 1 Attach a pen.**
- 2 Load a sheet on which register marks are printed.**
 - Creating Register Marks
- 3 Press on the local mode screen.**
 - The machine switches to jog mode.
- 4 Use to move the pen nib close to the center of the register mark detection position.**
 - Register mark detection should be performed at a position at least 1 mm from the register mark.

Mark shape	
Type 1	Type 2

- 5 Press the [END] key to exit jog mode.**
 - The system returns to local mode.
- 6 Press the [FUNCTION] key.**
- 7 Use to select [MARK sensor], then press the [ENTER/HOLD] key.**
- 8 Check to confirm that [Sensor Check] is displayed, then press the [ENTER/HOLD] key.**
- 9 Set the register mark detection conditions.**
 - ["Setting Register Mark Detection Conditions"\(P. 85\)](#)
 - The register mark detection conditions set are retained even when the power is turned off.

10 Press the [ENTER/HOLD] to start detection.

- The machine automatically detects the lines in the X and Y directions (automatic detection operation: plus X direction > minus X direction > plus Y direction > minus Y direction).

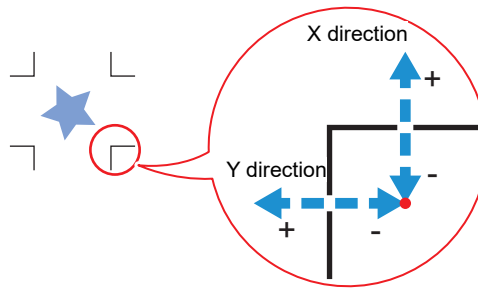

- A buzzer sounds each time a line is detected (four buzzers in all). If any of the buzzers fails to sound, refer to the following:

["Correcting the LED Pointer Position"\(P. 163\)](#)

Correcting the LED Pointer Position

If the register marks cannot be read properly, the register mark sensor and LED pointer positions may be misaligned. If this occurs, correct the LED pointer position.

1 Attach a pen to the tool holder.

- ["Using a Pen"\(P. 63\)](#)

2 Load copy paper.

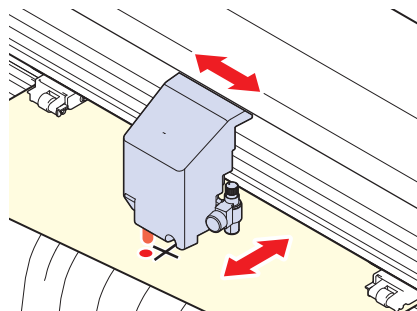

3 Press the [FUNCTION] key on the local mode screen.

4 Use ▲▼ to select [MARK sensor], then press the [ENTER/HOLD] key.

5 Use ▲▼ to select [POINTER OFS], then press the [ENTER/HOLD] key.

- A 10 mm cross pattern is drawn.
- The LED pointer turns on and moves to the center of the cross pattern.

6 Use ▲▼◀▶ to move the LED pointer so that the center aligns with the center of the cross pattern.

7 Press the [ENTER/HOLD] key to exit.

- The correction amount is saved and the system returns to local mode.
- The settings are retained even if [SETUP RESET] is selected.









8 Check the following again.

-  "Checking Register Mark Sensor Responsiveness"(P. 162)
- If the buzzer does not sound four times, check the printed register mark conditions and contact your local distributor, our sales office, or service center.





Aligning the Register Mark Sensor Position

The offset between the cutter and register mark sensor can be adjusted.

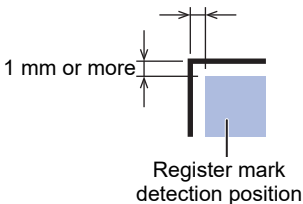
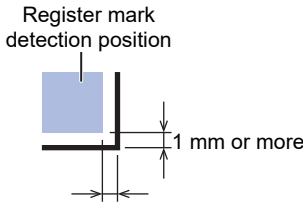
Up to 8 correction value types can be registered. When multiple types of media are used, the register mark detection position may shift in a specific direction depending on the media characteristics. Select a media number in the register mark detection settings and register the most suitable adjustment values for that media, and the adjustment values for that media will be applied only by selecting the media number.

- 1 Attach a cutter to the cutter holder.**
- 2 Load a sheet on which register marks are printed.**
 - Creating Register Marks
- 3 Press     on the local mode screen.**
 - The machine switches to jog mode.
- 4 Use     to move the pen nib close to the center of the register mark detection position.**
 - Register mark detection should be performed at a position at least 1 mm from the register mark.

Mark shape	
Type 1	Type 2
	

- 5 Press the [FUNCTION] key in local mode.**
- 6 Use   to select [MARK sensor], then press the [ENTER/HOLD] key.**
- 7 Use   to select [SENSOR OFS], then press the [ENTER/HOLD] key.**

8 Check to confirm that a media number in the register mark detection settings is selected and the current correction values are displayed, then press the [ENTER/HOLD] key.

- After (one) register mark has been detected, auxiliary lines are cut for the register mark center lines together with five auxiliary lines at 0.2 mm intervals on either side of the center lines.

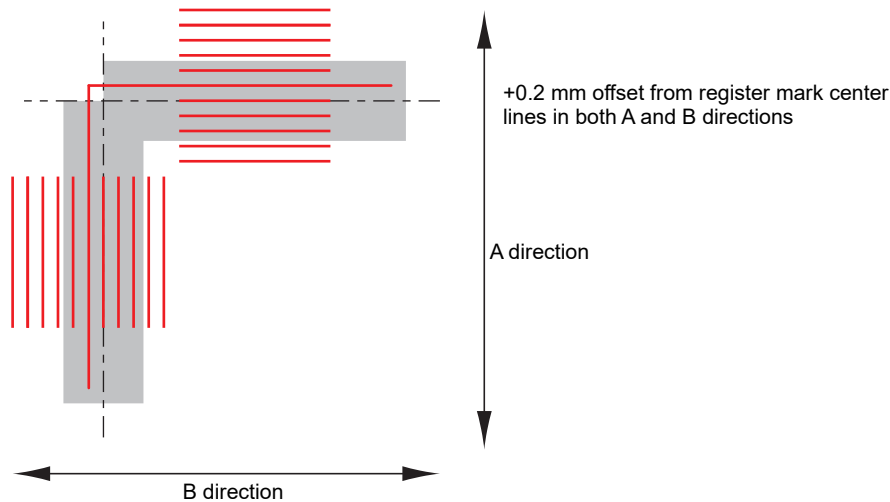

9 Use ▲▼ to enter the A direction correction value (mm) and ◀▶ to enter the B direction correction value (mm), then press the [ENTER/HOLD] key.

- If the offset is +0.2 mm, enter "-0.2".
- The correction amount is saved and the system returns to local mode.

Important!

- The settings are retained even when the power is turned off.
- The sensor offset set using this operation will not be reset by [SETUP RESET].

Investigating the Cause of Cutting Failures

The machine cuts a sample stored in the unit to troubleshoot problems when data cannot be cut properly. Executing a sample cut will clear any data saved in the receive buffer.

- 1 Press the [FUNCTION] key in local mode.
- 2 Use ▲▼ to select [SAMPLE CUT], then press the [ENTER/HOLD] key.
- 3 Use ▲▼ to select the sample data.
 - There are two sample types: "Cut" and "LOGO".
 - If "Cut" is selected, proceed to Step 5.

Sample	
Cut	LOGO
Cut	MIMAKI

- 4 When cutting with "LOGO" selected, press ◀▶ to specify the scaling factor (1 to 999 %).
- 5 Press the [ENTER/HOLD] key to start cutting.
 - Cutting starts.

● **Sample Cut Results**

- Sample data can be cut properly, but not other data.
 - There is a problem with the host computer.
- Sample data as well as other data cannot be cut properly. (When the start/end points remain uncut)
 - There is a problem with the cutting plotter. Increase the pressure using [ADJ-PRS OFS].  "ADJ-PRS OFFSET"(P. 140)

8.2 Problems Indicated by Messages



If a problem occurs, a message will appear on the display.







Take appropriate measures based on the message. If a message is displayed again even after you take the recommended corrective action, contact your local dealer or our service office.



Error Messages

Check the error details in the following table corresponding to the error numbers displayed:

If the problem persists even after carrying out the corrective action corresponding to the error number, contact your local distributor, our sales office, or service center.

Error number	Message	Cause	Corrective action
401	MOTOR X	<ul style="list-style-type: none"> The X motor was overloaded. 	Check the following points: <ol style="list-style-type: none"> Check to confirm the sheet is loaded correctly.  "Loading a Sheet"(P. 44) Check for anything that may obstruct carriage movement. Set the sheet setting to "HEAVY". When using roll sheet, feed to pull out the required amount of sheet in advance to provide sufficient slack. Turn off the power and wait a while before turning the power back on.  "Turning Off the Power"(P. 38)
402	MOTOR Y	<ul style="list-style-type: none"> The Y motor was overloaded. 	
403	X Current	<ul style="list-style-type: none"> An overcurrent was detected in the X motor. 	
404	Y Current	<ul style="list-style-type: none"> An overcurrent was detected in the Y motor. 	
41b	** NO MEDIA **	<ul style="list-style-type: none"> An enabling operation was performed after sheet detection. 	
50a	Y ORIGIN	<ul style="list-style-type: none"> A problem was detected with Y origin detection (initialization). 	<ul style="list-style-type: none">  "Turning Off the Power"(P. 38)
50b	FRONT EDGE	<ul style="list-style-type: none"> A problem was detected with the front paper sensor. 	
50c	WIDTH	<ul style="list-style-type: none"> A problem was detected with sheet width detection. 	
520	REAR EDGE	<ul style="list-style-type: none"> A problem was detected with the rear paper sensor. 	
901	OPERATION	<ul style="list-style-type: none"> An inappropriate operation was performed on the operating panel. 	<ul style="list-style-type: none"> The operation is invalid.
902	DAT REMAIN	<ul style="list-style-type: none"> An inappropriate operation was performed while pausing. 	<ul style="list-style-type: none"> Either press the [REMOTE] key to cut the data or clear the data to abort the cut.
C02	MAIN RAM	<ul style="list-style-type: none"> An error occurred in the control RAM. 	<ul style="list-style-type: none"> Contact your local distributor, our sales office, or service center.
C04	EEPROM	<ul style="list-style-type: none"> An error occurred in the system ROM. 	

Error number	Message	Cause	Corrective action
C06	BUFFER	<ul style="list-style-type: none"> An error occurred in the receive buffer. 	
C08	POWER	<ul style="list-style-type: none"> An error occurred related to the motor. 	
C10	Commands	<ul style="list-style-type: none"> Received a code other than a COMMAND code. 	Check the following points: <ol style="list-style-type: none"> Clear the data and resend.  "Turning Off the Power"(P. 38) Check the USB cable connection.  "Using a USB Cable"(P. 33) Use a compliant USB cable.  "USB Connection Precautions"(P. 33)
C11	PARAMETER	<ul style="list-style-type: none"> Received parameter outside numerical value range 	
C12	DEVICE	<ul style="list-style-type: none"> Received an invalid device control command. 	
C13	PM OVER	<ul style="list-style-type: none"> The polygon buffer overflowed. 	<ul style="list-style-type: none"> Either set so as not to use polygon commands or use the MGL-Ic1 command.
C15	AUTO FEED	<ul style="list-style-type: none"> The length specified by the ZX command could not be fed. 	<ul style="list-style-type: none"> Reset the long sheet after data has been sent from the host computer, then perform multiple sheet cutting.
		<ul style="list-style-type: none"> The previous sheet length could not be fed for the second sheet data onward during divided cutting. 	<ul style="list-style-type: none"> Load a long sheet, then switch to remote mode again.
C16	AUTO I/F	<ul style="list-style-type: none"> The command could not be automatically recognized. 	<ul style="list-style-type: none"> Set the command name.  "SET UP"(P. 135)
C20	I/O	<ul style="list-style-type: none"> An error occurred in the communication conditions. 	<ul style="list-style-type: none"> Adjust the communication conditions to match the host computer.  "SET UP"(P. 135) > [INTERFACE]
C27	BUFFERover	<ul style="list-style-type: none"> An error occurred in the interface. 	<ul style="list-style-type: none"> Check the interface cable.
C31	NO DATA	<ul style="list-style-type: none"> Multiple sheet cutting was executed, but no data is saved to the receive buffer. 	<ul style="list-style-type: none"> Cut the data involved once more.
C32	DATAtooBIG	<ul style="list-style-type: none"> The received data is too big for multiple sheet cutting. 	<ul style="list-style-type: none"> Change the data size.
C33	SHEET SIZE	<ul style="list-style-type: none"> The sheet is too short in the feed direction. 	<ul style="list-style-type: none"> Use a longer sheet.
C36	MARK DETECT	<ul style="list-style-type: none"> Unable to detect register marks 	Check the following points: <ol style="list-style-type: none"> Check to confirm the register marks are placed properly.  "Register Marks"(P. 80) Use an uncurled sheet. Check the mark detection start position. Check to confirm the register marks are black and printed on a white background. Check to confirm the area between the register marks is clean and free of printing and images.

Error number	Message	Cause	Corrective action
			<p>6. Check to confirm there are no errors in the mark detection settings.</p> <p>7. If the area around the register marks is filled in, set [MARK DETECT] > [MARK FILL UP] setting to "ON".</p>
C37	MARK ORG	<ul style="list-style-type: none"> The register mark detection result shows that the register marks were outside the register mark reading range. 	<ul style="list-style-type: none"> Set the register marks within the register mark reading range.  "Reading Range of Register Marks"(P. 82)
C38	MARK SCALE	<ul style="list-style-type: none"> Register mark detection was performed, but the calculated correction value is abnormal, so either the detection was erroneous or the correction value was incorrectly specified. 	<ul style="list-style-type: none"> Check the correction value and repeat detection.
		<ul style="list-style-type: none"> The calculated scale compensation value was 1.3 or more or 0.7 or less. 	<ul style="list-style-type: none"> Eliminate any causes of mis-detection, such as blurred printed register mark data, before repeating.
		<ul style="list-style-type: none"> Mis-detected due to being too close to the adjacent image. 	<ul style="list-style-type: none"> Ensure an appropriate distance from the adjacent image before printing again.
		<ul style="list-style-type: none"> The specified register mark spacing is incorrect. 	<ul style="list-style-type: none"> Invalid register mark spacing was specified by the command, or data was incorrectly selected. Check the data to be output.
		<ul style="list-style-type: none"> Images were skipped due to the printed register marks not being aligned. 	<ul style="list-style-type: none"> Align the data and repeat printing.
		<ul style="list-style-type: none"> Printed register marks were not correctly read due to problems such as blurred register marks, and the register marks for the adjacent image were read instead. 	<ul style="list-style-type: none"> Repeat printing, taking care to prevent blurring.
C39	MARK ID	<ul style="list-style-type: none"> Register mark IDs could not be detected. (Data with IDs) 	<p>Check the following points:</p> <ul style="list-style-type: none"> Check to confirm that the paper is not curled. Check to confirm the register mark IDs are black printed on a white background. Use three pinch rollers when using thin sheets or sheets more than approximately 800 mm wide.
C51	PINCH POS*	<ul style="list-style-type: none"> The pinch rollers are not over the grit rollers. 	<ul style="list-style-type: none"> Reposition the pinch rollers above the grit rollers.
C60	PenEncoder	<ul style="list-style-type: none"> Unable to detect pen height 	<ul style="list-style-type: none"> Turn off the power and wait a while before turning the power back on.  "Turning Off the Power"(P. 38)



Error number	Message	Cause	Corrective action
C61	Pen Stroke	<ul style="list-style-type: none"> The pen height is incorrect. 	<p>Check the following points:</p> <ul style="list-style-type: none"> Make sure the pen line rubber is not worn or deformed and remains intact. Check to confirm nothing adheres to the pen line rubber. After installing the pen in a commercially available pen holder, check to confirm the installed position is correct.

Display Message List

These are messages displayed in remote mode.

They are not error messages, but take the appropriate action as necessary.

Message	Cause	Corrective action
** OFFSCALE **	<ul style="list-style-type: none"> The cutting data extends beyond the available cutting area. Or, the sheet was cut correctly to the end and then stopped. 	<ul style="list-style-type: none"> Either increase the sheet size or reduce the data size. Or, use the divided cutting function.
** NO SHEET **	<ul style="list-style-type: none"> No sheet is loaded, or a transparent sheet is loaded. 	<ul style="list-style-type: none"> Load a sheet. Or disable the sheet sensor.
** VIEW **	<ul style="list-style-type: none"> NOT-READY (NR;) was received from the host computer, and the machine is in local mode. 	<ul style="list-style-type: none"> Perform the necessary options such as sheet detection and origin setting, then press the [REMOTE] key to select remote mode.
** DIGITIZE **	<ul style="list-style-type: none"> The digitize command (DP;) was received from the host computer, and the machine is in digitize mode. 	<ul style="list-style-type: none"> Move the pen nib as necessary, then press the [REMOTE] key. To cancel digitize mode, use the [FUNCTION] key to clear the data.
** END COPY **	<ul style="list-style-type: none"> The received data contains an origin update command (ZT;, !PG;), and the process ended after one copy. 	<ul style="list-style-type: none"> Multiple sheet cutting is not possible. Reset the host computer to perform multiple sheet cutting.
* DIVISION * 5s	<ul style="list-style-type: none"> The machine is waiting for the next data after cutting data exceeding the sheet width when using divided cutting. 	<ul style="list-style-type: none"> If data from the host computer is not received for 10 seconds, this is recognized as a data division. Frame cutting and mark cutting are then performed, and the machine switches to local mode.
* END DIVISION *	<p>Displayed in the following situations:</p> <ul style="list-style-type: none"> When data is received containing the origin update command (ZT;,!PG;) When the sheet width does not exceed 1 cm When the sample cut exceeds the sheet width When 2-point line correction is enabled 	<ul style="list-style-type: none"> Divided cutting is not possible.

Message	Cause	Corrective action
	<ul style="list-style-type: none"> When register mark detection has been performed 	
COPY SKIP	<ul style="list-style-type: none"> A register mark could not be read during register mark reading continuous copying. (Reading of one pattern skipped) 	<ul style="list-style-type: none"> [ERROR 36: MARK DETECT] is displayed if marks cannot be read continuously for five or more patterns. There is no problem provided register marks can be read correctly from the next pattern onward.
MEDIA SKEW <ENT>	<ul style="list-style-type: none"> The sheet offset exceeded the skew check setting length.  "Skew check setting [SKEW CHECK]"(P. 87) 	<ul style="list-style-type: none"> Reload the sheet, then press the [ENTER/HOLD] key.
PAUSE REMOTE/END	<ul style="list-style-type: none"> The detection operation was paused due to the [REMOTE] key being pressed while register mark detection was in progress. 	<ul style="list-style-type: none"> Pressing the [REMOTE] key again resumes detection. Or press the [END] key to end.
SHEET EXCHANGE	<ul style="list-style-type: none"> Awaiting sheet change for continuous copying in leaf mode. 	<ul style="list-style-type: none"> Replace the leaf sheet (cut sheet), then restart continuous copying.
	<ul style="list-style-type: none"> Printing is not contained within the sheet length range during Y direction divided cutting. 	<ul style="list-style-type: none"> Load a longer sheet.
* ! F-ROM WRITING	<ul style="list-style-type: none"> Tool parameters and setting parameters are being stored. The stored data is saved in flash memory which is not cleared even when the power is turned off. 	<ul style="list-style-type: none"> Do not turn off the power while this is displayed.
SHEET END REM/END	<ul style="list-style-type: none"> The sheet end was detected during register mark detection or while cutting with a roll sheet. 	<ul style="list-style-type: none"> Cutting cannot be continued as the roll sheet has ended. Press the [END] key and replace with a new sheet.
	<ul style="list-style-type: none"> The sheet is lifting up. 	<ul style="list-style-type: none"> Correct the sheet lifting, then press the [REMOTE] key to restart cutting.
	<ul style="list-style-type: none"> Strong light is shining on the machine from the rear. 	<ul style="list-style-type: none"> Take measures to minimize the effects of light, such as by changing the orientation of the machine, then press the [REMOTE] key to restart cutting.
DATA ID NotExist	<ul style="list-style-type: none"> Register mark IDs could not be detected. (Data without IDs) 	<ul style="list-style-type: none"> If no ID data is present, disable [DATA ID CODE].  "DATA ID CODE"(P. 88)
During remote control. [ent]	<ul style="list-style-type: none"> Appears when using Mimaki Remote Access. Key operations using the machine operating panel will be invalid. 	<ul style="list-style-type: none"> Pressing the [ENTER/HOLD] key forcibly quits remote control from Mimaki Remote Access, and enables operation using the machine operating panel.  "Operating the Main Unit Panel Remotely [R.CONTRL]"(P. 118)

Message	Cause	Corrective action
Replace with CRE	<ul style="list-style-type: none">• Waiting for the cutter or pen to be replaced with the creasing tool.	<ul style="list-style-type: none">• Replace with the creasing tool, then press the [REMOTE] key.
Replace with PEN	<ul style="list-style-type: none">• Waiting for the creasing tool to be replaced with the pen.	<ul style="list-style-type: none">• Replace with the pen, then press the [REMOTE] key.
Replace with CUT	<ul style="list-style-type: none">• Waiting for the creasing tool to be replaced with the cutter.	<ul style="list-style-type: none">• Replace with the cutter, then press the [REMOTE] key.

Chapter 9 Appendix



This chapter

This chapter explains the specifications of this machine.

Specifications	174	Setting Sheet.....	177
Repetition Accuracy Conditions	176		

9.1 Specifications

Item		Details		
		CG-60AR	CG-100AR	CG-130AR
Compatible sheet widths		90 to 740 mm (4 to 28 inches)	90 to 1250 mm (4 to 48 inches)	90 to 1550 mm (4 to 60 inches)
Compatible roll sheet	External diameter	Max. 150 mm	Max. 200 mm	
	Weight	8 kg or less	20 kg or less	
Cutting range ^{*1}		606 mm x 51 m	1,070 mm x 51 m	1,370 mm x 51 m
Maximum speed	45° direction	103 cm/s		
Setting speed (cutting/printing)		1 to 10 cm/s (1 cm/s steps)		
		10 to 70 cm/s (5 cm/s steps)		
		73 cm/s		
Mechanical resolution		X axis: 2.5 µm, Y axis: 5 µm		
Program steps		25, 10 µm (MGL-IIc)		
		100, 50 µm (MGL-Ic1)		
Repetition accuracy ^{*2}		0.2 mm/2 m (excluding elongation due to film moisture)		
Accuracy range (Repetition accuracy)		586 mm x 2 m	1,050 mm x 2 m	1,350 mm x 2 m
		Depending on specified film and cutting conditions		
Maximum pressure		550 g		
Pressure setting	Cutter	10 to 20 g (in 2 g steps)		
		20 to 100 g (in 5g steps)		
		100 to 550 g (in 10g steps)		
	pen	10 to 20 g (in 2 g steps)		
		20 to 100 g (in 5g steps)		
		100 to 150 g (in 10g steps)		
	Creasing tool (option)	10 to 20 g (in 2 g steps)		
		20 to 100 g (in 5g steps)		
		100 to 550 g (in 10g steps)		
Film that can be cut		PVC sheet (not more than 0.25 mm thick, including lamination), rubber sheet, fluorescent sheet ^{*3} , reflective sheet ^{*3} , coated card ^{*4} (using the optional sheet table)		
Usable tools		Eccentric cutter, ballpoint pen, commercially available ballpoint pen (option) ^{*5} , creasing tool (option)		
Command ^{*6}		MGL-IIc, MGL-Ic1		
Interface		USB, RS-232C, Ethernet		
Receive buffer		Approx. 27 Mbytes standard (approx. 17 Mbytes with sorting enabled)		
Operating conditions		5 °C to 35°C, 35 to 75 % (Rh) with no condensation		

Item		Details		
		CG-60AR	CG-100AR	CG-130AR
Power supply capacity		100 to 240 V AC, 140 W to 168 W	100 to 240 V AC, 190 W to 228 W	
External dimensions	Width	1,010 mm	1,510 mm	1,810 mm
	Depth	355 mm	580 mm	
	Height	355 mm	1,160 mm	
Weight		17 kg (without legs) 27 kg (with legs: option)	35 kg	43 kg
Noise level ^{*7}	At standby	50 dB (vacuum fan at low speed)		
	Operating	70 dB (continuous noise)		

- *1. The software used may include restrictions on the maximum feed length. The maximum feed length may also be restricted depending on how the sheet is loaded or obstructions at the front or rear. As a guide, set the maximum feed length to 2 m for one set of data.
- *2. For information on repetition accuracy, refer to the next page.
- *3. When using fluorescent sheet blade (SPB-0007) or reflective sheet blade (SPB-0006)
- *4. Cutting quality and accuracy may be reduced with thick coated card.
- *5. Use one 8 to 9 mm in diameter free of protrusions and tapers on the clamped part. The pen nib position may vary depending on the pen, resulting in reduced image quality.
- *6. MGL-IIc ESC. commands cannot be used when using USB or Ethernet.
- *7. Values based on Mimaki standard measurements.

9.2 Repetition Accuracy Conditions

● **Plotter status**

- Using dedicated roll-placing table
- Clamping pressure: High

● **Sheet loading status**

- Sheet side margin: 20 mm or more
- Sheet front status: No warping or lifting
- Sheet is not detached from backing sheet (air bubbles inside) due to sheet folding
- Sheet is correctly loaded according to sheet detection
- No debris or foreign matter on sheet (Use of sheet basket recommended: Sheet basket is an option)
- Length of sheet to be used has been pulled out using sheet feed when using roll sheet
- No loose winding when using roll sheet (No steps on left/right ends)

● **Cutting speed**

- 40 cm/s or less (when using cutter provided)

● **Cutting data**

- Maintenance test pattern (5 continuous return cycles in long direction)

● **Sheet type**

- 3M Scotchcal Series 7725
- LINTEC Viewcal900 Series

Depending on the material, accuracy may not be guaranteed for cutting sheets or inkjet sheets other than those listed here.

9.3 Setting Sheet

When changing the sheet to be cut (or printed), it may be necessary to perform distance correction, depending on the sheet thickness.  ["Length Correction \[DIST.COMP.\]"\(P. 103\)](#)

This setting sheet is useful for writing down the sheet to be replaced and correction value in such cases.

Sheet Name: A = B =	Sheet Name: A = B =
Sheet Name: A = B =	Sheet Name: A = B =
Sheet Name: A = B =	Sheet Name: A = B =
Sheet Name: A = B =	Sheet Name: A = B =
Sheet Name: A = B =	Sheet Name: A = B =
Sheet Name: A = B =	Sheet Name: A = B =
Sheet Name: A = B =	Sheet Name: A = B =
Sheet Name: A = B =	Sheet Name: A = B =

Index

<hr/> A <hr/>	
AC inlet.....	26
ADJ-PRS OFFSET.....	137, 166
<hr/> B <hr/>	
BILT.....	16
<hr/> C <hr/>	
Carriage.....	23
Center clamp.....	25, 57
Clamp.....	57
Clamp lever.....	23
Clamp pressure lever.....	25
CORNER CUT.....	123, 137
CURVE MODE.....	137
CUT MODE.....	135
Cutting slot.....	23
<hr/> D <hr/>	
Disclaimers.....	6
DUMMY CUT.....	136
<hr/> E <hr/>	
EVENT MAIL.....	125
<hr/> F <hr/>	
FCC.....	6
FUNC.....	32
<hr/> G <hr/>	
Grit roller.....	23, 28
<hr/> H <hr/>	
Half cut.....	71
<hr/> I <hr/>	
ID Cut Guide.....	97
ID Cut.....	97
Inlet.....	36
Interference.....	6

L	
LAN cable	33
LAN connector	26
LOCAL mode	31
M	
Margin	82
MARK DETECT	80, 82, 168, 169
MARK sensor	161, 163
MENU mode	31
Multiple sheet cutting	106
N	
NOT-READY mode	31
O	
Offset	71
Operating panel	23, 30
OVER CUT	123, 137
P	
Pen line	23, 148
Pinch roller guide mark	24
Pinch rollers	23, 28, 55, 56, 147
Platen	23
Power cable	36
Power outlet	37
Power plug	37
Power supply switch	23
R	
Receive buffer	106, 160, 168
Register mark	78, 80, 81, 82, 84
Register mark detection range	83
REMOTE	32
REMOTE mode	31
Roll bars	25
Roll holder	25
Roll stay	23
Roll stopper	25
RS-232C cable	34
RS-232C interface connector	25

S

SAMPLE CUT.....	160
SHEET sensor.....	24, 25, 28
SHEET TYPE	136
Switching hub	34
Symbols.....	9

T

TOOL.....	32
Tray	25

U

UP SPEED	136
USB interface cable.....	33
USB interface connector	26

W

Warning Label	14
---------------------	----

MEMO

CG-AR Series Operation Manual

April, 2023

MIMAKI ENGINEERING CO.,LTD.

2182-3 Shigeno-otsu, Tomi-shi, Nagano 389-0512 JAPAN

D203577-12-27042023

