

Operation Manual

Printer Cutter

CJV150-75
CJV150-107
CJV150-130
CJV150-160

BS INK MODEL

Operation Manual

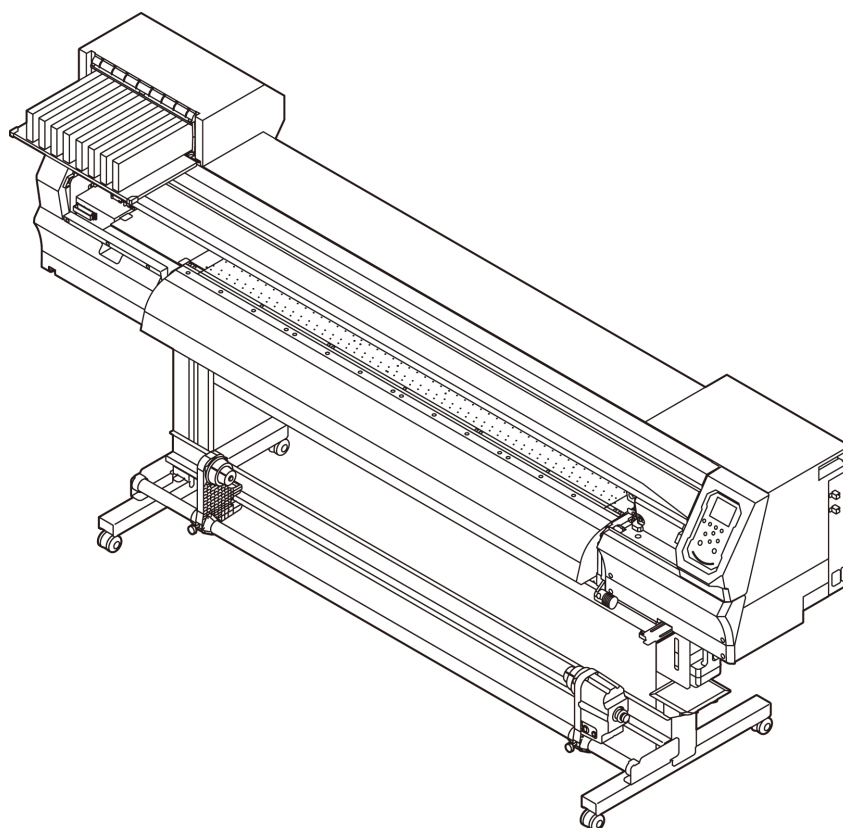

You can also download the latest manual from our website.

MIMAKI ENGINEERING CO., LTD.

<https://mimaki.com/>

D202773-18

Original instructions

Table of Contents

Foreword	vii
CAUTION	vii
Requests	vii
FCC Statement (USA)	vii
Interference to televisions and radios	vii
About usable ink	vii
Safety Precautions	viii
Symbols	viii
Safety interlock	xi
Warning labels	xii

Chapter 1 Before Use

Moving This Machine	1-2
Where to Install This Machine	1-2
Working Environmental Temperature.....	1-2
Moving This Machine	1-2
Names of Parts and Functions	1-3
Front Side of the Machine	1-3
Rear Side and Right Side of the Machine	1-4
Operation Panel	1-5
Media sensor.....	1-7
Carriage.....	1-7
Cutter blade and slot for cutting	1-7
Capping station	1-7
Pinch Rollers and Grit Rollers	1-7
Connecting Cables	1-8
Connecting USB2.0 Interface Cable	1-8
Connecting the power cable.....	1-8
Inserting ink cartridges	1-9
Caution in handling of ink cartridges	1-9
Inserting ink cartridges	1-9
Changing an ink cartridge	1-10
For Ink cartridge lamps.....	1-10
Restrictions concerning the product.....	1-10
How to assemble ink cartridge	1-11
Media	1-12
Usable sizes of media	1-12
Caution in handling of medias.....	1-12
Menu mode	1-13

Chapter 2 Basic Operations

Workflow of printing	2-2
Turning the Power ON/OFF	2-3
Turning the Power ON.....	2-3
Turning the Power OFF.....	2-3
Setting a Media	2-4
Adjusting the Head Height.....	2-4

Adjusting the Position of the Pinch Roller According to the State of a Media.....	2-5
Maximum Print Area/Cut Area.....	2-10
Notes When Using media Holder.....	2-10
Setting a roll media.....	2-11
Setting the pinch roller pressure.....	2-13
Take-up device.....	2-14
Setting leaf media.....	2-16
Changing the printing origin.....	2-17
Preparing for the Heaters.....	2-17
Changing the Temperature Settings for the Heaters.....	2-17
Test Printing.....	2-18
Test Printing.....	2-18
Perform test printing with the normal test pattern.....	2-19
Perform test printing with the test pattern for checking white ink....	2-19
Head Cleaning.....	2-20
About head cleaning.....	2-20
Perform head cleaning depending on the test printing result.....	2-20
Setting of Media Correction.....	2-21
Setting of Media Correction.....	2-21
If the Positions of Dots Shift... ..	2-21
Printing Data.....	2-22
Starting a Printing Operation.....	2-22
Stopping a Printing Operation.....	2-22
Deleting Received Data (Data Clear).....	2-22
Cutting a media.....	2-22
Workflow of cutting.....	2-23
Installing Tools.....	2-24
When a Cutter Is Used.....	2-24
How to Install a Ballpoint Pen.....	2-25
Setting the cutting conditions.....	2-27
About the Cut Conditions.....	2-27
Select the tool condition.....	2-27
Set the Cut Conditions.....	2-28
Test Cutting.....	2-29
Cutting Data.....	2-29
Setting the origin.....	2-29
Start cutting.....	2-29
Stopping a Cutting Operation (Data Clear).....	2-30
Removing the Cutter Unit Temporarily.....	2-30
Cutting a media.....	2-30

Chapter 3 Setup

About SETUP MENU.....	3-2
SETUP MENU table.....	3-3
Register the optimal print conditions to match the use.....	3-4
Setting of Media Correction.....	3-5
If the Positions of Dots Shift... ..	3-6
Setting the HEATER.....	3-6
Setting of Logical Seek.....	3-7
Setting of Drying Time.....	3-7

Setting of Left and Right Margins	3-8
Setting of VacuumFan	3-8
Setting of Feed Speed	3-8
Setting of MAPS	3-8
Setting Auto Cleaning	3-9
Setting Interval wiping	3-9
About MACHINE SETUP MENU	3-10
MACHINE SETUP MENU table	3-11
Setting a AUTO Power-off	3-12
Setting Take-up unit	3-12
Setting the Display of Media Residual	3-13
Setting the Display of Media Detection	3-13
When using 600 ml cartridge	3-14
Setting a LANGUAGE	3-16
Setting Time	3-16
Setting Unit (Temperature/ Length)	3-17
Setting a KEY BUZZER	3-17
Setting the CONFIRM. FEED	3-17
Setting the SPACE FEED MODE	3-17
Set the network	3-18
Setting event mail function	3-18
Initializing the Settings	3-22
About NOZZLE CHECK MENU	3-23
INFORMATION MENU table	3-23
Printing Check Flow	3-24
Printing Operations at “Nozzle Missing” Judgment and Error Occurrence	3-24
Setting the Printing Check	3-25
Setting the NOZZLE RECOVERY	3-25
Setting the Judgement Condition	3-25
About INFORMATION MENU	3-26
INFORMATION MENU table	3-27
Displaying the Information	3-27

Chapter 4 Cutting Funcion

Cutting Out Data with Registration Mark	4-2
Workflow of Cutting Out Data with Registration Mark	4-2
Precautions in inputting data with registration marks	4-3
Setting of Detecting the Registration Marks	4-5
Detecting the printed registration mark	4-6
About CUTTING MENU	4-7
Cutting MENU table	4-8
Setting the CUT MODE	4-9
perform multiple Cuttings (Copy function)	4-9
SETUP SUB MENU	4-10
Setting the DIVISION CUT	4-10
Make the media without uncut area (OVER CUT function)	4-12
Other SETUP SUB MENU	4-12
SETUP RESET	4-13
Maintenance Function	4-14
Maintenance of Mark Sensor	4-14

Perform SAMPLE CUT to Find out the Cause of Cutting Error.....	4-16
Cutting a Medium into Multiple Pieces with a Certain Length	4-16
Cutting out Data without Register Marks (PC ORIGIN OFFSET)....	4-17
Setting the Scale Adjust	4-18

Chapter 5 Maintenance

Maintenance	5-2
Precautions for Maintenance.....	5-2
About Cleaning Solution	5-2
Cleaning the Exterior Surfaces.....	5-2
Cleaning the Platen	5-2
Cleaning the Media Sensor	5-3
Cleaning the Media Press	5-3
Cleaning the Jam Sensor	5-3
Replacing the exhaust BOX filter or exhaust BOX.	5-3
Replace the CP pad set.	5-4
Replacing the pen line rubber or pen line sponge.	5-5
Cleaning and replacing the pinch roller.	5-5
About MAINTENANCE MENU	5-6
MAINTENANCE MENUs at-a-glance.....	5-7
Daily care other than the maintenance menu	5-7
Maintaining the Capping Station	5-8
Cleaning the Wiper and Cap	5-8
Washing the Head Nozzle	5-9
Washing the Ink Discharge Passage	5-10
When the Machine Is Not Used for a Long Time	5-10
Cleaning the Ink Head and the Area around It	5-12
Nozzle Recovery Function	5-13
Reset the set value.....	5-14
Automatic Maintenance Function	5-15
Setting the Refreshing Intervals	5-15
Setting the Pump Tube & Nozzle Wash Intervals	5-15
Setting the Cleaning Intervals and Type	5-16
Fill up Ink	5-16
Ink Maintenance	5-17
White Ink Maintenance.....	5-17
Replacing consumables	5-17
Replacing the wiper	5-17
If a Waste Ink Tank Confirmation Message Appears	5-18
Replacing the waste ink tank before the waste ink tank confirmation message is displayed	5-19
Replacing the Cutter Blade	5-19
Replacing and Adjusting the Cutter Blade	5-20
Replacing the cutter	5-20
Adjusting the Cutter Blade.....	5-21
Replacing the cutter other than supplied one.....	5-21
Adjusting blade edge of cutter other than supplied one	5-21

Chapter 6 Troubleshooting

Troubleshooting	6-2
Power does not turn on	6-2
The machine does not start printing	6-2
Media get jammed / media is soiled	6-2
The heater's temperature will not rise to the set level	6-3
Image quality is poor	6-3
Nozzle is clogged	6-3
Ink cartridge warning appears	6-4
When the ink leakage occurs	6-4
Warning / Error Messages	6-5
Warning messages.....	6-5
Error messages	6-8

Chapter 7 Appendix

Specifications	7-2
Printer Section Specifications.....	7-2
Cutter Section Specifications	7-2
Common Specifications.....	7-3
Ink specifications	7-4
Setting orders of ink cartridges	7-5
LICENSE Library	7-6
Sheet for inquiry	7-7



Foreword

Congratulations on your purchase of MIMAKI color ink jet printer "CJV150 series BS INK MODEL" .

"CJV150 series BS INK MODEL" (called as this machine hereafter) is a color inkjet printer that can print on 1.3m or 1.6m-width media with BS ink(BS3/ BS4) realizing high image quality.

CAUTION

THIS LIMITED WARRANTY OF MIMAKI SHALL BE THE SOLE AND EXCLUSIVE WARRANTY AND IS IN LIEU OF ALL OTHER WARRANTIES, EXPRESS OR IMPLIED, INCLUDING, BUT NOT LIMITED TO, ANY IMPLIED WARRANTY OF MERCHANTABILITY OR FITNESS, AND MIMAKI NEITHER ASSUMES NOR AUTHORIZES DEALER TO ASSUME FOR IT ANY OTHER OBLIGATION OR LIABILITY OR MAKE ANY OTHER WARRANTY OR MAKE ANY OTHER WARRANTY IN CONNECTION WITH ANY PRODUCT WITHOUT MIMAKI'S PRIOR WRITTEN CONSENT.

IN NO EVENT SHALL MIMAKI BE LIABLE FOR SPECIAL, INCIDENTAL OR CONSEQUENTIAL DAMAGES OR FOR LOSS OF PROFITS OF DEALER OR CUSTOMERS OF ANY PRODUCT.

Requests

- This manual is describing the operations and maintenance of this machine.
- The illustrations used in this manual may vary depending on the machine.
- This manual has been carefully prepared for your easy understanding, however, please do not hesitate to contact a distributor in your district or our office if you have any inquiry.
- The contents of this Operation Manual are subject to change for improvement without notice.
- You can also download the latest manual from our website.

FCC Statement (USA)

This machine has been tested and found to comply with the limits for a Class A digital device, pursuant to Part 15 of the FCC Rules. These limits are designed to provide reasonable protection against harmful interference when the printer is operated in a commercial environment. this machine generates, uses and can radiate radio frequency energy and, if not installed and used in accordance with the operation manual, may cause harmful interference to radio communications.

Operation of this machine in a residential area is likely to cause harmful interference in which case the user will be required to correct the interference at his/her own expense.

The limits stipulated by FCC rules might be exceeded if Mimaki-recommended cable is not used for connections of this machine.

To prevent this, use of Mimaki-recommended cable is essential for connecting this machine.

Interference to televisions and radios

The printer described in this manual generates high frequency when operating.

This machine can interfere with the reception of radios and televisions if set up or used under improper conditions.

This machine is not guaranteed against any damage to specific-purpose radios and televisions.

If you feel that this machine might be causing reception interference with your radio or television, check by turning this machine's power switch on and off. If the reception interference disappears when the printer's power is turned off, it is likely that this machine is the cause of the interference.

If this is the case, try to eliminate it by performing any or a combination of the following procedures.

- Change the direction of the receiving antenna of your radio/television until there is no reception interference.
- Move the receiver away from the product.
- Plug the power cord of this machine into an outlet which is isolated from power circuits connected to the television set or radio.

About usable ink

You can use BS ink(BS3/ BS4) for this machine.

Reproduction of this manual is strictly prohibited.
All Rights Reserved. Copyright
© 2016 MIMAKI ENGINEERING Co., Ltd.

Safety Precautions









Symbols

Symbols are used in this manual for safe operation and for prevention of damage to the machine.

The indicated sign is different depending on the content of caution.



Symbols and their meanings are given below. Please follow these instructions as you read this manual.

Examples of symbols









Meaning	
	Failure to observe the instructions given with this symbol can result in death or serious injuries to personnel. Be sure to read it carefully and use it properly.
	Failure to observe the instructions given with this symbol can result in injuries to personnel or damage to property.
	Important notes in use of this machine are given with this symbol. Understand the notes thoroughly to operate the machine properly.
	Useful information is given with this symbol. Refer to the information to operate the machine properly.
	Indicates the reference page for related contents.
	The symbol "△" indicates that the instructions must be observed as strictly as the CAUTION instructions (including DANGER and WARNING instructions). A sign representing a precaution (the sign shown at left warns of hazardous voltage) is shown in the triangle.
	The symbol "⊘" indicates that the action shown is prohibited. A sign representing a prohibited action (the sign shown at left prohibits disassembly) is shown in or around the circle.
	The symbol "●" indicates that the action shown must be taken without fail or the instructions must be observed without fail. A sign representing a particular instruction (the sign shown at left instructs to unplug the cable from the wall outlet) is shown in the circle.





Warning for Use

WARNING	
	<ul style="list-style-type: none"> Do not use a flammable spray or solvent inside or around the machine. It may cause a fire or electric shock due to ignition. Do not place containers or small metal objects containing vases, flower pots, cups, cosmetics, medicines, water, etc. on or near the machine. If it spills or gets inside, it may cause a fire or electric shock.

WARNING	
	<ul style="list-style-type: none"> The set of power cables provided with this machine is for use with this machine only. It cannot be used with other electrical devices. Do not use any power cables other than the ones provided with the machine. It may cause a fire or electric shock. Do not damage, break or work upon the power cable. If a heavy material is placed on the power cable, or if it is heated or pulled, the power cable may be damaged, resulting in fire or electric shocks. Avoid use in humid places. Also, do not pour water on the unit. It may cause a fire, electric shock, or malfunction. Use of the machine under an abnormal condition where it produces smoke or strange smell can result in fire or electric shocks. Be sure to turn off the power switch immediately and unplug the cable from the power outlet. Check first that the machine no longer produces smoke, and then contact your distributor or our sales office for repair. Never disassemble or modify your machine or ink cartridge by yourself. It may cause an electric shock or malfunction. Do not use extension cables. It may cause a fire or electric shock. Keep the power plug prong clear of any foreign object such as a piece of metal. It may cause a fire or electric shock. Do not use multi-outlet extension. It may cause a fire or electric shock. If the power cable is damaged or the core wire is exposed or broken, ask your service representative to replace it. Using it as it is may cause a fire or electric shock. Do not handle the power plug with wet hands. It may cause an electric shock. Grasp by holding the plug itself when removing the power plug from power outlet. Do not pull the power cable. The cable may be damaged, resulting in a fire or electric shock. Do not use a voltage other than the displayed. It may cause a fire or electric shock. Do not use a power frequency other than the indicated. It may cause a fire or electric shock. If a foreign object such as metal, water, or liquid enters this machine, turn it off immediately. After that, be sure to remove the power plug from the outlet and contact your service representative. Using it as it is may cause a fire or electric shock. If ink leaks, turn off the main power switch, disconnect the power plug, and contact your local distributor, our sales office, or call center. Make sure that dust and dirt do not adhere to the heater on the media transport surface. It may cause a fire or electric shock.
	<ul style="list-style-type: none"> Since solvent ink may ignite, do not use fire in the place where the machine is used.
	<ul style="list-style-type: none"> Keep children away from this machine.

Precautions in Use

	
Handling of the power cable	
	<ul style="list-style-type: none"> • Connect to a socket-outlet with determinate polarity. • For Inlet 1 and 2, be sure to supply power from the outlet of the same voltage. • Be sure to connect it to a power outlet near the machine so that it can be easily removed. • Unplug the cable from the power outlet and clean the blade of the plug and the surrounding area, at least once a year. If dust accumulates, it may cause a fire. • Do not use a voltage other than the displayed. • Check the voltage of the power outlet and the capacity of the circuit breaker before you plug the power cable. Plug each power cable to different outlet that has independent circuit breaker. If you plug more than one power cable to power outlets that share the same circuit breaker, the power may be cut off by the breaker.
Power supply	
	<ul style="list-style-type: none"> • Leave the breaker turned ON at all times. • Do not turn off the main power switch on the right side.
Note on maintenance	
 	<ul style="list-style-type: none"> • Pay close attention to ventilation and be sure to wear the included safety glasses and gloves provided, and the filtering face mask, when handling ink, maintenance cleaning solution, waste ink, or other solutions used in this machine. Failure to do so may result in ink or other liquids splashing and coming into contact with the skin, eyes, or mouth. • Gloves are consumables. Use a commercial product when the attached gloves are used up.
Be careful with the movable parts	
	<ul style="list-style-type: none"> • Keep fingers and other parts of the body away from dangerous moving parts. • Do not touch the rolling grit roller; otherwise, you may hurt your fingers or tear off your finger nails. • Keep your head and hands away from any moving parts during cutting operation; otherwise, you may get your hair caught in the machine or get injuries. • Wear proper clothes. (Do not wear loose-fit clothes or accessories). Bind a long hair.
Caution with heater	
	<ul style="list-style-type: none"> • Do not spill liquid on the Media Transfer Surface as this may cause failure of the heater or firing. • Do not touch Media Transfer Surface heaters with a bare hand while the heater is hot; otherwise, you can get burned.
Notes on handling media	
	<ul style="list-style-type: none"> • When setting the roll media, set it by two or more people. The weight of the roll media may hurt your back. • When changing media, be careful not to get your fingers caught or injured. • There is a media cutter inside the machine. When replacing or replenishing media or removing a media jam, do not touch anything other than the locations specified in this manual. It may cause injury.
Handling of ink	

	
	<ul style="list-style-type: none"> • There are precautionary notes on ink on the ink cartridge. Read it carefully and fully understand it before using it. • Before using ink and cleaning solution, be sure to read the Safety Data Sheet (SDS). • Keep ink away from fire. Also, be sure that the room is well ventilated when using or handling ink. • Immediately wipe off any ink, maintenance washing liquid, waste ink, or other liquid used with the product that contacts your skin. Wash using soap and rinse with plenty of water. Failure to wash off liquid may result in skin inflammation. If your skin becomes irritated or painful, seek medical attention immediately. • If ink, maintenance washing liquid, waste ink, or any other liquid used in the product comes into contact with your eyes, rinse immediately with plenty of clean water. Rinse for at least 15 minutes. If you wear contact lenses and they can be easily removed, remove after rinsing for at least 15 minutes with clean water. Be sure to rinse the undersides of your eyelids. Failure to rinse off liquid may result in blindness or impaired vision. If your eyes become irritated or painful, seek medical attention immediately. • If ink, maintenance washing liquid, waste ink, or any other liquid used in the product enters your mouth or is swallowed, gargle with water immediately. Do not induce vomiting. Seek medical attention promptly. Inducing vomiting may cause liquid to enter the airway. • If a large amount of vapor is inhaled, move to a well-ventilated area, keep warm, and rest in a posture that allows easy breathing. If the condition does not improve, seek medical attention promptly.
Caution with cutters	
	<ul style="list-style-type: none"> • Do not touch the cutter blade, which is very sharp. • Store the cutter blade in a place that is out of the reach of children. In addition, dispose of used cutter blades according to regional laws and regulations. • Do not shake the tool after having set the cutter. Otherwise, the blade edge may pop out, causing you to get injured.
Notes When Handling the Main Unit	
	<ul style="list-style-type: none"> • Do not use in poorly ventilated or sealed rooms. • Provide sufficient ventilation when using. • Contact your service representative for cleaning inside the unit. If dust is accumulated inside the projector and it is not cleaned for a long time, it may cause a fire or malfunction.

CAUTIONS and NOTES

	
Clump lever	
<ul style="list-style-type: none"> • Do not raise the clamp lever during printing. Printing will end. 	

WARNING

Handling of ink cartridges

- Safety is evaluated by our recommended ink. Please use our recommended ink for safe use.
- If the ink cartridge is moved from a cold place to a warm place, leave it in the room temperature for three hours or more before using it.
- Open the ink cartridge just before installation. If the ink is left open for a long time, normal printing performance may not be ensured.
- Make sure to store ink cartridges in a cool and dark place.
- Keep ink cartridges and waste ink tank out of reach of children.
- Be sure to thoroughly consume the ink cartridge within 3 months after opening it. If it has passed for a long time after opening, the print quality would be poor.
- When you no longer need ink cartridges, ink packs, and waste ink, please hand them over to your distributor or service representative. If you dispose them by yourself, please follow the regulations stipulated by the industrial waste disposer or the local regulations of each country.
- Do not hit the ink cartridge strongly or shake it violently. Ink may leak from the cartridge.
- Do not refill ink in the ink pack or ink cartridge. We are not responsible for any problems caused by using refilled ink.
- Do not touch or stain the contact area of the ink cartridge PCB. It may cause a PCB failure.
- Make sure that you shake the white and silver ink cartridges several times before printing.

Handling of media

- Use recommended media.
Use our recommended media to print with stable and high image quality.
- Pay attention to the expansion and contraction of the media. Do not use media that has just been opened. The media may expand and contract depending on the room temperature and humidity. Open the package and expose it to the place of use for at least 30 minutes before attaching it to the unit.
- Do not use curled media.
In addition to causing media jams, it also affects the image quality.
Also, use media with tight curls after removing the curls. If a regular-sized coated sheet of media is rolled and stored, the coated side has to face outside.
- Be careful to dusts on the edge face of the media.
Some rolls have dusts contained in the package gathered on the edge surface of the roll. If you use as it is, the drawing quality may be degraded due to nozzle missing or ink drops. Be sure to set the roll after removing dusts adhering on the edge face of the roll.
- Set the heater temperature according to the characteristics of the media. (Heater-equipped machine)
- Set the temperature of the Pre-heater, Print heater and Post-heater according to the media type and characteristics. In addition, there is a method to specify the automatic temperature setting from the operation panel by specifying the profile from the dedicated RIP. Refer to the instruction manual of your RIP for the specification method. (Heater-equipped machine)
- Do not leave the media on for a long time with the heater ON. (Heater-equipped machine)

WARNING

Periodic replacement parts

- Some parts of this machine must be replaced with a new one regularly. In order to use the machine for a long time, be sure to subscribe to an annual maintenance contract.

Notes on maintenance

- Use in a room with as little dust as possible.
- Dust can also cause ink drops to fall from the head to the media during printing. In this case, clean around the head.
- Clean the capping station and wiper frequently (removal of dust and paper powder).
- Keep the front cover closed even when not printing. Dust may accumulate on the head nozzles.

Protection of media from dust

- Store media in a bag. Wiping off dust accumulated on media will adversely affect the media due to static electricity.
- When leaving the workshop after the working hours, do not leave any media on the roll hanger. Dust will adhere on the media.

Disposition of this machine

- Consult your sales or service representative for proper disposal of this machine. Otherwise, commission an industrial waste disposal company.

Cautions on Installation

CAUTION

A place exposed to direct sunlight

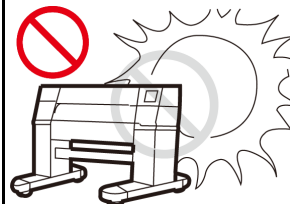

On an inclined surface



A place that vibrates



A place exposed to direct air flow from an air conditioner or the like.

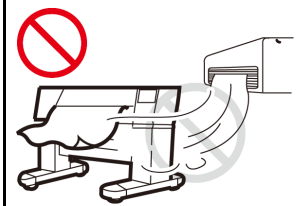

A place where temperature or humidity varies significantly



- Use the machine under the following environmental conditions:
- Operating environment:
20 to 30 °C
(68 to 86 °F)
35 to 65 % (Rh)

Around a place where fire is used

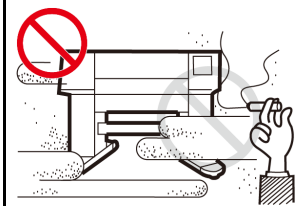

Safety interlock



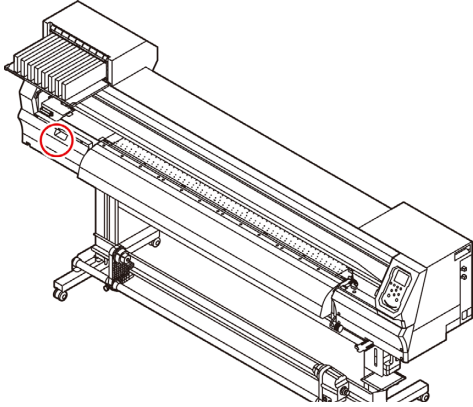



This machine is equipped with interlocks to terminate the operation for your safety when the cover opens during printing etc. (red circle parts in the figure below).

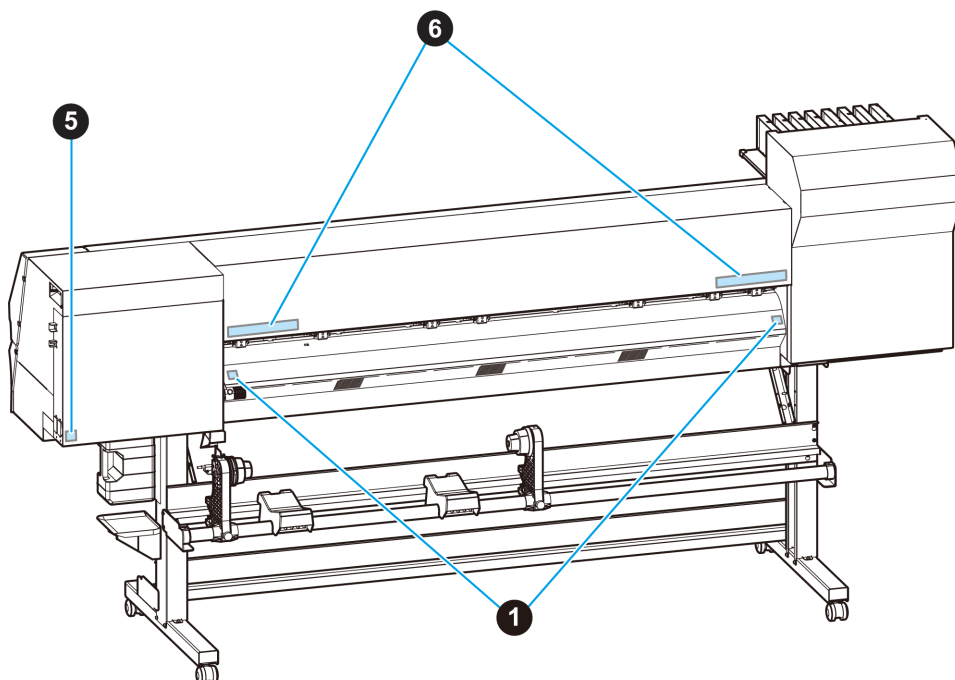
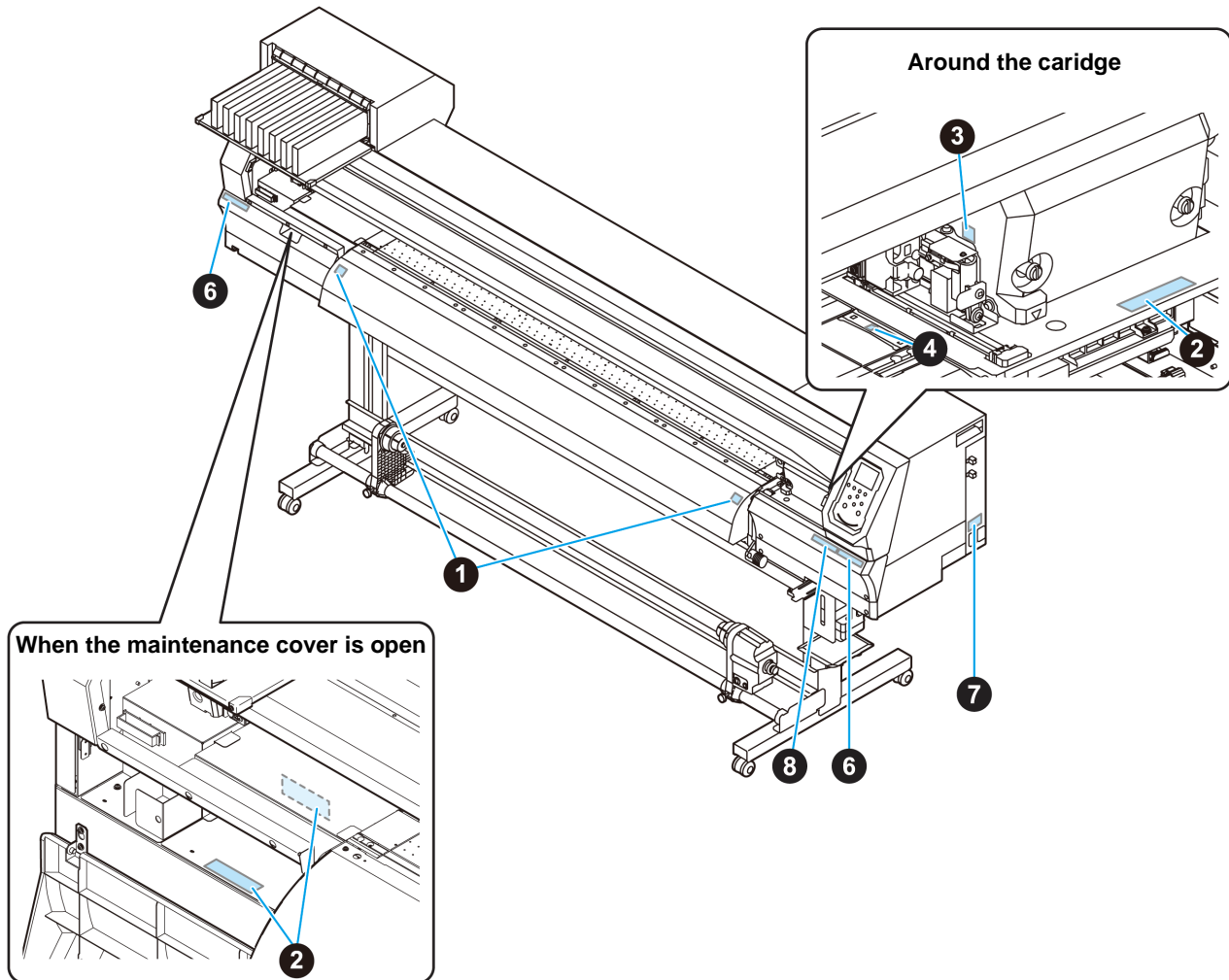

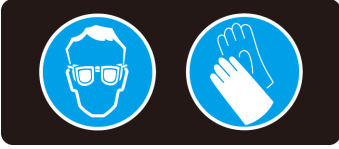
Warning labels

Warning labels are stuck on the machine. Be sure to fully understand the warning given on the labels. If a warning label is illegible due to stains or has come off, purchase a new one from a distributor or our sales office.



No.	Reorder	Label
1	M903239	
2	M903330	
3	M903405	
4	M906144	
5	M907935	
6	M905811	
7	M906031	
8	M905935	

Chapter 1

Before Use



This chapter

Describes the items required to understand before use, such as the name of each part of the machine or the installation procedures.

Moving This Machine	1-2	Connecting the power cable	1-8
Where to Install This Machine	1-2	Inserting ink cartridges	1-9
Working Environmental Temperature	1-2	Caution in handling of ink cartridges	1-9
Moving This Machine	1-2	Inserting ink cartridges	1-9
Names of Parts and Functions.....	1-3	Changing an ink cartridge	1-10
Front Side of the Machine	1-3	For Ink cartridge lamps	1-10
Rear Side and Right Side of the Machine ...	1-4	Restrictions concerning the product	1-10
Operation Panel	1-5	How to assemble ink cartridge	1-11
Media sensor	1-7	Media	1-12
Carriage	1-7	Usable sizes of media	1-12
Cutter blade and slot for cutting	1-7	Caution in handling of medias	1-12
Capping station	1-7	Menu mode	1-13
Pinch Rollers and Grit Rollers	1-7		
Connecting Cables.....	1-8		
Connecting USB2.0 Interface Cable	1-8		

Moving This Machine

Where to Install This Machine

Secure a suitable installation space before assembling this machine.

The place of installation must have enough space for not only this machine itself, but also for the printing operation.

Model	Width	Depth	Height	Gross weight
CJV150-75 BS INK MODEL	1695mm (66.7in)	700mm (27.6in)	1392mm (54.8in)	120kg (264.6lb)
CJV150-107 BS INK MODEL	2255mm (88.8in)	700mm (27.6in)	1392mm (54.8in)	142kg (313.1lb)
CJV150-130 BS INK MODEL	2525mm (99.4in)	700mm (27.6in)	1392mm (54.8in)	157kg (346.1lb)
CJV150-160 BS INK MODEL	2775mm (109.3in)	700mm (27.6in)	1392mm (54.8in)	168kg (370.4lb)

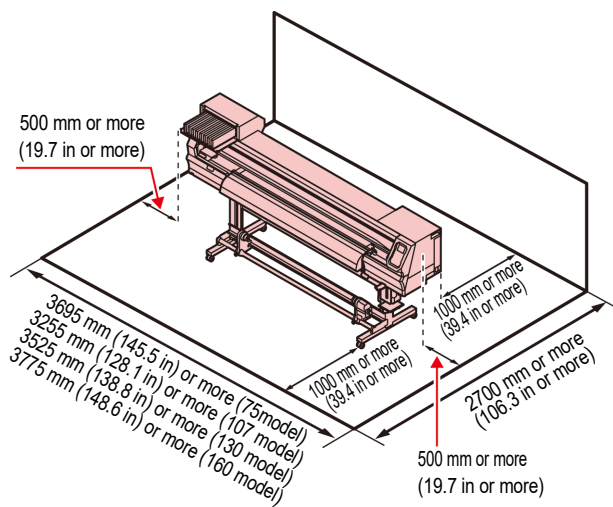

Working Environmental Temperature

Use this machine in an environment of 20 to 30°C to ensure reliable printing.

Moving This Machine

Move this machine according to the following steps when this machine needs to be moved on the same step-free floor.



- When the machine is moved to any place other than on the same step-free floor, contact your distributor or our service office. If you move it by yourself, failure or damage may occur. Be sure to request your distributor or our service office to move this machine.



- When moving this machine, take care that it does not receive a significant impact.
- Be sure to lock the casters after moving of this machine.

1 Remove the caster blocks.

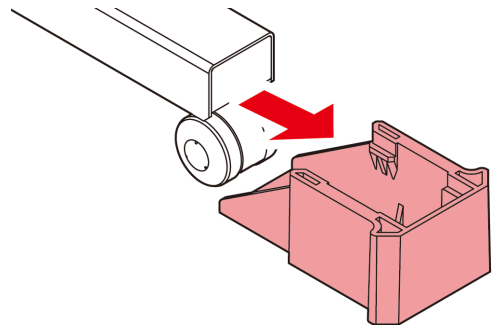

2 Move this machine as shown in the figure.

- For safety, be sure to operate it with 4 people or more.
- Do not push the cover to move this machine since the cover may be broken.

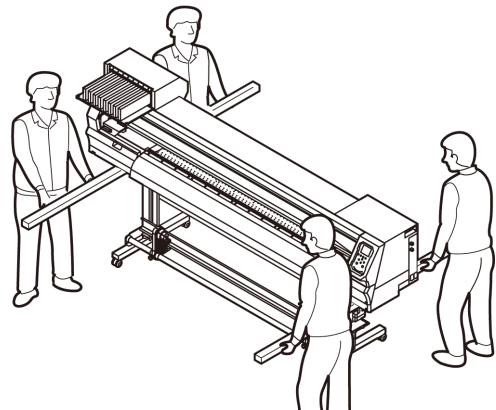

3 Reinstall the caster blocks.

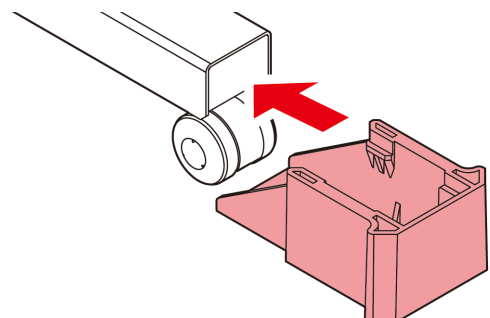

Names of Parts and Functions

Front Side of the Machine

Ink cartridges

Each cartridge contains an ink of a particular color.

Cartridge protection cover

This prevents an injury or breakage of the machine due to a protrusion of the ink cartridge. (It is located under the ink cartridge.)

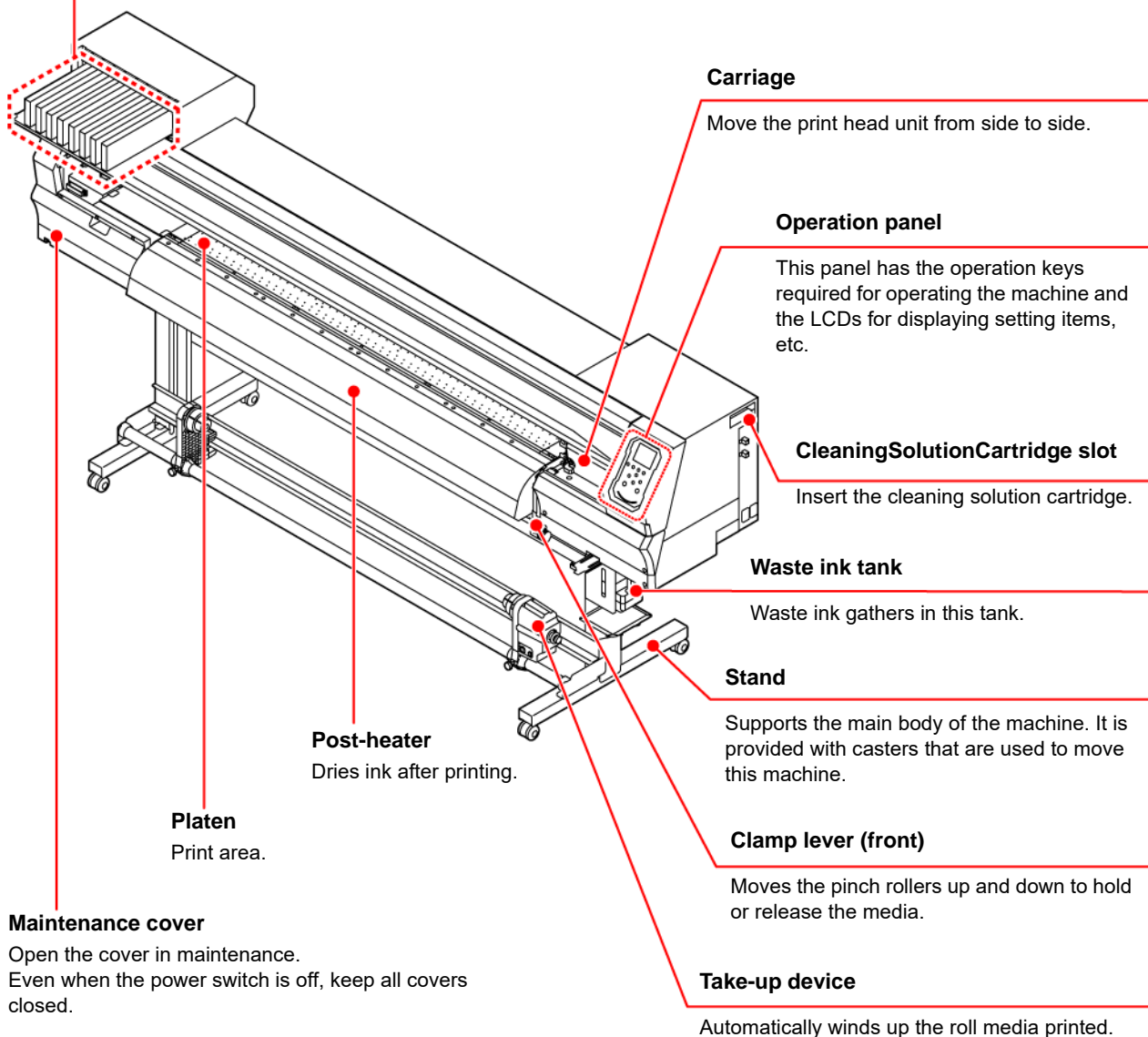

Rear Side and Right Side of the Machine

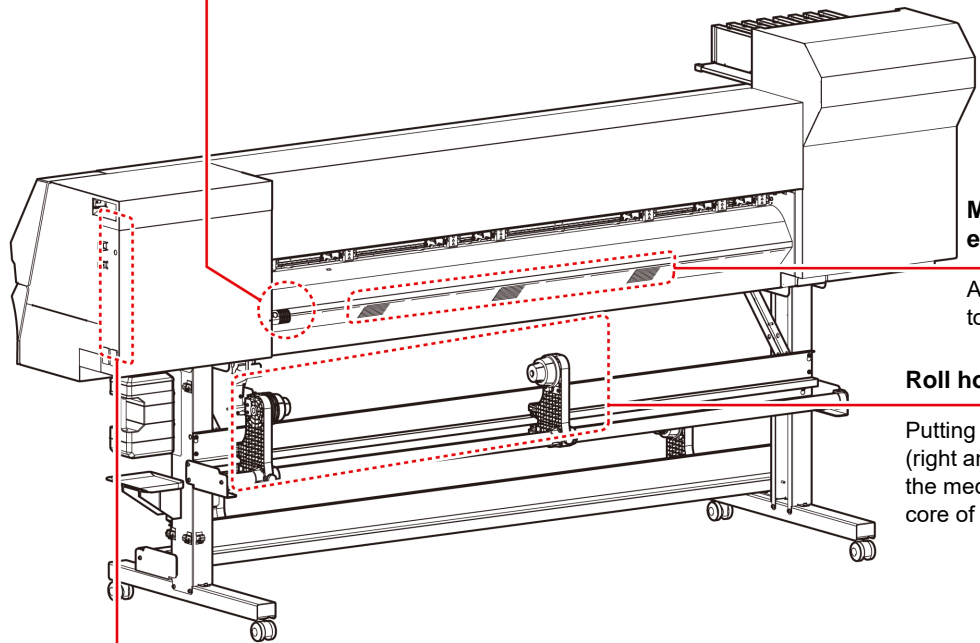
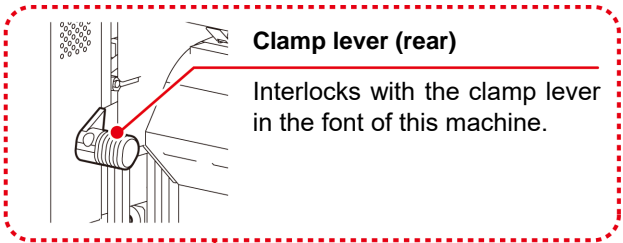

Media adsorption fan exhaust port

An exhaust port for the fan to adsorb media.

Roll holders

Putting this into the paper core (right and left) of a roll media, hold the media. It supports the paper core of 2 inch and 3 inch.

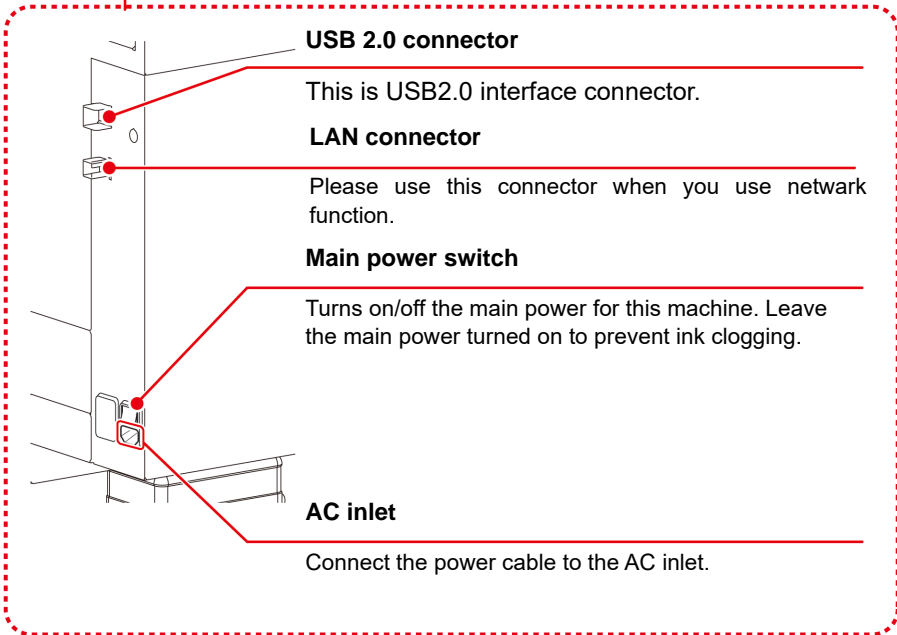

Operation Panel

Use the operation panel to make settings for printing or operate this machine.

SEL key

Changes over the functions of the function keys ([FUNC1]–[FUNC3]).

[FUNC1] / [FUNC2] / [FUNC3] key

Press this to set various functions or to do test printing. The function keys' functions are changed each time [SEL] key is pressed.

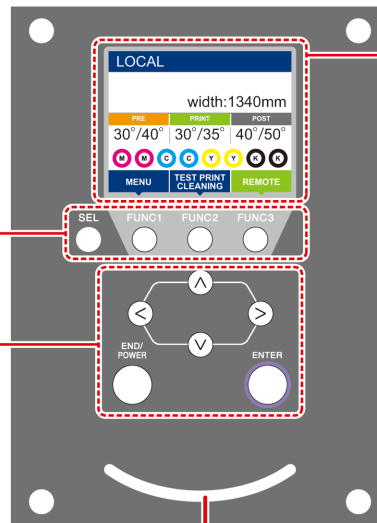

Display

Displays the following items:

- Printer status
- Set media width
- Heater temperature (current temperature/set temperature)
- Ink status ^{*1}
- Functions assigned to [FUNC1] to [FUNC3] ^{*2}

JOG key

Use these keys to shift the carriage or the media in [LOCAL]. Also use them to select an item of printing conditions.

END/POWER key

Cancels the last input value or returns the setting menu to the immediate higher level of the hierarchy. Also, press this to turn the power on or off. (Give it a long press to turn the power off.)

ENTER key

Registers the last input value as the setting value or goes to the immediate lower level of the hierarchy.

Status indicator lamp

Indicates the machine's status (printing, error occurred, etc).

Condition of Lamp	Condition of machine
OFF	Machine is in LOCAL mode, no print data has been received, and no errors have occurred.
Lit steady Light blue	Switched to REMOTE mode.
Flashing Light blue	Currently printing.
	In test printing: printing a pattern stored inside the machine.
Lit steady blue	Print data still remains in the machine.
Flashing red	Error has occurred.
Lit steady red	Error (SYSTEM HALT) has occurred.



- The power switch under the operation panel lights in blue when the power is turned on, and off when the power switch is turned off. The ink clogging prevention function is periodically operated even when the power switch is OFF if the main power switch keeps being ON. (Auto maintenance function) P.1-4

















*1 : Ink Status

Ink status (e.g., remaining ink levels) and ink errors are indicated by icons.

Icon	Details
	The ink remaining levels will be indicated with the nine types of the following icons.
	Ink full
	Approx. 1/8 used
	Approx. 1/4 used
	Approx. 3/8 used
	Approx. 1/2 used
	Approx. 5/8 used
	Approx. 3/4 used
	Approx. 7/8 used
	Near end
	Displayed when ink near end. The remaining ink is little, so provide new ink.
	Displayed when ink end or ink error occurs. The printing cannot be performed.
	Displayed when the ink expiration date expires. Replace with new ink or use it up as soon as possible. It is possible to print.

*2 : Functions assigned to [FUNC1] to [FUNC3]

Contents of functions assigned to [FUNC1] to [FUNC3] are described below.

Icon	Contents
	Displays "MENU" for setting functions.
	Displays maintenance functions such as test print, cleaning, etc.
	Shifts to REMOTE from LOCAL and starts printing.
	Displays adjustment functions such as FEED COMP, DROP.POScorrect, etc.
	Sets the heater temperature.
	Executes data clear.
	Suspends printing in REMOTE and shifts to LOCAL.
	Executes media cut.
	When there are multiple items on the MENU screen or other screens, it moves to the previous page.
	When there are multiple items on the MENU screen or other screens, it moves to the next page.
	Used for completing confirmation when warning message has been displayed and so on.
	Used for turning functions OFF or cancelling them, for example, when turning heater settings OFF and so on.
	Some kind of setting or function is assigned. Operate according to the description of each function.
	Switches between enable/disable when selecting multiple items, for example, when selecting target head for cleaning and so on.
	Set the cutting conditions.
	Check or set the settings related to cutting, such as test cutting.
	Set the pressure of the pinch rollers.



- The color of icons changes according to the state of the printer.
 - When the icon is green : The printer is in REMOTE mode.
 - When the icon is dark blue : The printer is in LOCAL mode.
 - When the icon is yellow : A warning has been issued.
 - When the icon is red : An error has been issued.

Media sensor

The media sensor detects the presence of the media and the media length.

This machine has one media sensor on the platen (in the rear).

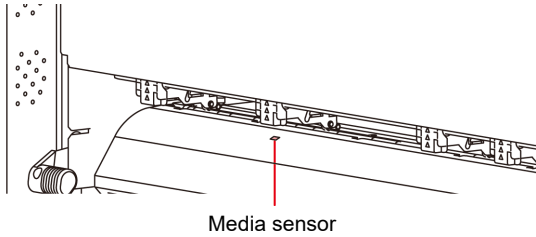

Media sensor

Important!

- When setting a media, be sure to cover the media sensors located on the rear of the platen. The media cannot be detected unless it is placed over the sensor.

Carriage

The carriage consists of the printer unit and the cutter unit.

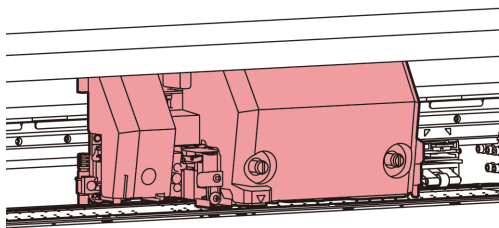

Printer Unit

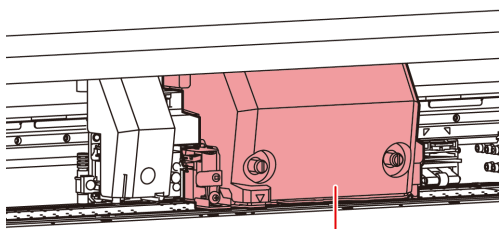

Printer unit

Cutter Unit

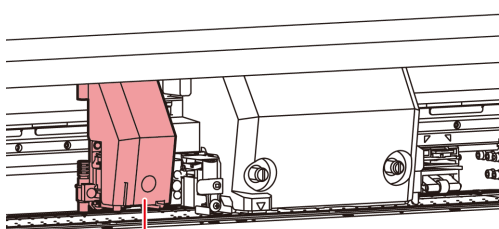

Cutter unit

Cutter blade and slot for cutting

The carriage is provided with a cutter unit for cutting off the media that has been printed on.

The cutter cuts off the sheet of media along the slot for cutting on the platen.

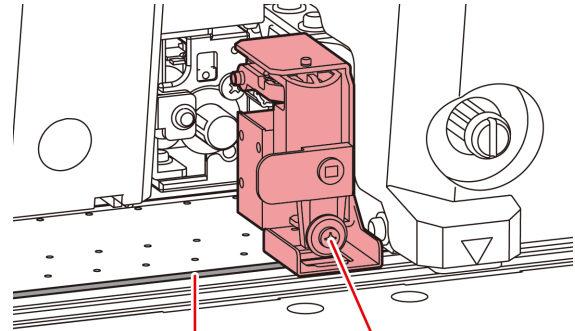

slot for cutting

Cutter part

Capping station

The capping station consists of the ink caps, the wiper for cleaning the heads, etc.

The ink caps prevent the nozzles in the ink heads from drying up.

The wiper cleans the nozzles in the heads.

The wiper is consumable. If the wiper is deformed or the media is stained, replace the wiper with a new one.



- Be sure to wear the attached safety glasses in cleaning within the capping station to protect your eyes against ink. Otherwise, you may get ink in your eyes.

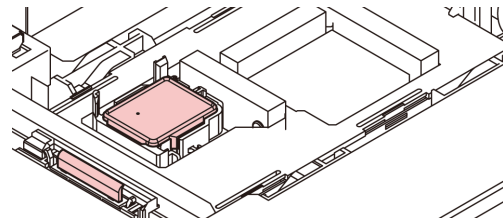

Pinch Rollers and Grit Rollers

This machine retains the media with the pinch rollers and the grit rollers.

Important!

- Keep the pinch rollers lifted up when this machine is not in use. If the pinch rollers are left lowered for an extended period of time, they can be deformed and fail to securely retain the media.

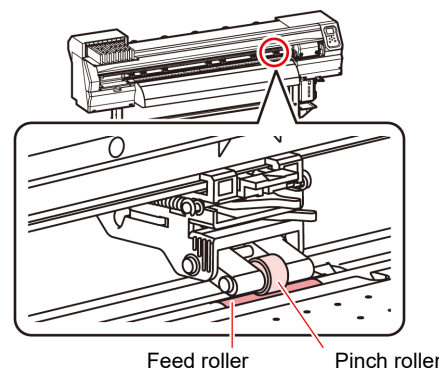

Feed roller

Pinch roller

Connecting Cables

Connecting USB2.0 Interface Cable

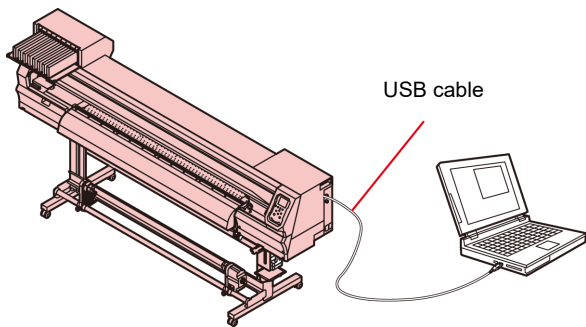

Connect the PC and this machine with the USB2.0 interface cable.



- Your RIP must be compatible with USB 2.0.
- Contact a RIP maker near your location or our office when the USB2.0 interface is not attached to the PC.

Notes on USB 2.0 Interface



- Your RIP must be compatible with USB 2.0.

When two or more CJV BS INK MODEL machines are connected to one personal computer

When two or more CJV BS INK MODEL machines are connected to one personal computer, the personal computer may not recognize all the CJV BS INK MODEL machines normally.

Reconnect the unrecognized CJV BS INK MODEL machine to another USB port, if available, and check to see if it is recognized. If the CJV BS INK MODEL machine is not recognized by the newly connected USB port, use USB 2.0 repeater cables available on the market.

Notes on peripheral devices in USB high speed mode

When a peripheral device (USB memory or USB HDD) to be operated in USB high speed mode is connected to the same personal computer that a CJV BS INK MODEL machine is connected to, the USB device may not be recognized. When CJV BS INK MODEL is connected to the personal computer to which an external HDD is connected via USB, the speed of data output to CJV BS INK MODEL may drop. That can cause the head unit to stop temporarily at the right or left end during printing.

Removing USB memory

If a USB memory module is inserted in the personal computer to which a CJV BS INK MODEL machine is connected, click "Stop" in the "Safely Remove Hardware" window by following the instructions given there first and remove the module.

Leaving a USB memory module inserted can cause [ERROR 10 COMMAND ERROR].

Copy the data onto the hard disk before outputting it for printing.

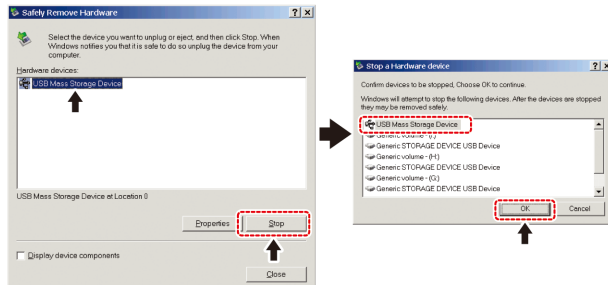

Connecting the power cable

1 Insert the power cable into an inlet of the machine.

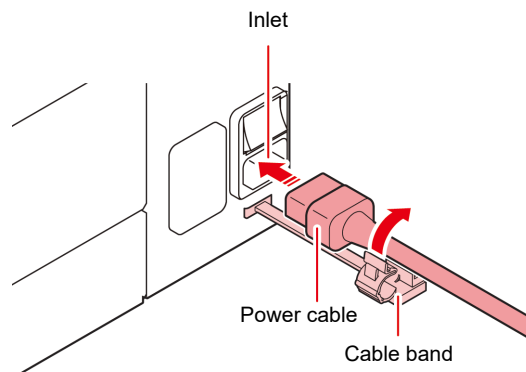

2 Secure a cable band.

- Secure the cable with the cable band attached to this machine.

3 Insert the power plug into a plug socket.

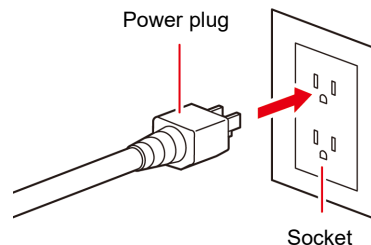

- Do not use any power cables other than the attached power cable.



- Be sure to connect the power cable to the outlet near this machine, and make sure that the power cable can be easily removed.
- Connect the power cable to the grounded outlet. Otherwise, it may result in fire or an electric shock.

Inserting ink cartridges

Caution in handling of ink cartridges



- There are precautionary notes on ink on the ink cartridge. Read it carefully and fully understand it before using it.
- Before using ink and cleaning solution, be sure to read the Safety Data Sheet (SDS).
- Keep ink away from fire. Also, be sure that the room is well ventilated when using or handling ink.
- Immediately wipe off any ink, maintenance washing liquid, waste ink, or other liquid used with the product that contacts your skin. Wash using soap and rinse with plenty of water. Failure to wash off liquid may result in skin inflammation. If your skin becomes irritated or painful, seek medical attention immediately.
- If ink, maintenance washing liquid, waste ink, or any other liquid used in the product comes into contact with your eyes, rinse immediately with plenty of clean water. Rinse for at least 15 minutes. If you wear contact lenses and they can be easily removed, remove after rinsing for at least 15 minutes with clean water. Be sure to rinse the undersides of your eyelids. Failure to rinse off liquid may result in blindness or impaired vision. If your eyes become irritated or painful, seek medical attention immediately.
- If ink, maintenance washing liquid, waste ink, or any other liquid used in the product enters your mouth or is swallowed, gargle with water immediately. Do not induce vomiting. Seek medical attention promptly. Inducing vomiting may cause liquid to enter the airway.
- If a large amount of vapor is inhaled, move to a well-ventilated area, keep warm, and rest in a posture that allows easy breathing. If the condition does not improve, seek medical attention promptly.
- Safety is evaluated by our recommended ink. Please use our recommended ink for safe use.
- If the ink cartridge is moved from a cold place to a warm place, leave it in the room temperature for three hours or more before using it.
- Open the ink cartridge just before installation. If the ink is left open for a long time, normal printing performance may not be ensured.
- Make sure to store ink cartridges in a cool and dark place.
- Keep ink cartridges and waste ink tank out of reach of children.
- Be sure to thoroughly consume the ink cartridge within 3 months after opening it. If it has passed for a long time after opening, the print quality would be poor.
- When you no longer need ink cartridges, ink packs, and waste ink, please hand them over to your distributor or service representative. If you dispose them by yourself, please follow the regulations stipulated by the industrial waste disposer or the local regulations of each country.



- Do not disassemble the ink cartridges.
- Do not hit the ink cartridge strongly or shake it violently. Ink may leak from the cartridge.
- Do not refill ink in the ink pack or ink cartridge. We are not responsible for any problems caused by using refilled ink.
- Do not touch or stain the contact area of the ink cartridge PCB. It may cause a PCB failure.

Inserting ink cartridges

1

Shake the ink cartridge.

- To prevent ink from leaking when you shake the cartridge, wear gloves and firmly cover the A part of the upper surface of the cartridge and the B part of the bottom surface of the cartridge with paper towels. Then, shake it more than twenty times right and left so that ink flows inside the cartridge.



A part
(the place to stick a needle)



B part
(the slot on the bottom)

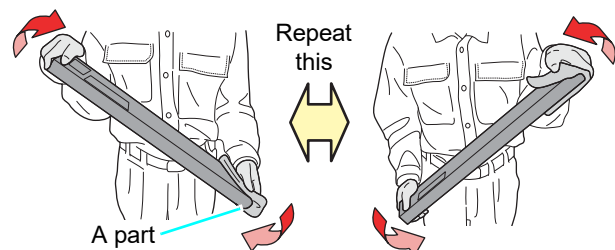

A part

Cover with paper towel firmly
and shake ink slowly



- If you shake it too strong, the pack inside may be damaged and it may cause ink leakage. Therefore, perform this carefully.
- If the remaining amount of ink is less, ink in the cartridge cannot be beaten enough. Tilt the cartridge until it becomes vertical.
- If you do not shake the ink periodically, the print quality may deteriorate rapidly. Shake about once a month.
- Shake the 2L ink pack in the same way. However, the MBIS (optional) must be attached and removed no more than 10 times in total.

2

Insert the ink cartridge.

- Insert the ink cartridge lengthwise with the surface having ink IC chips pointing to the left side.

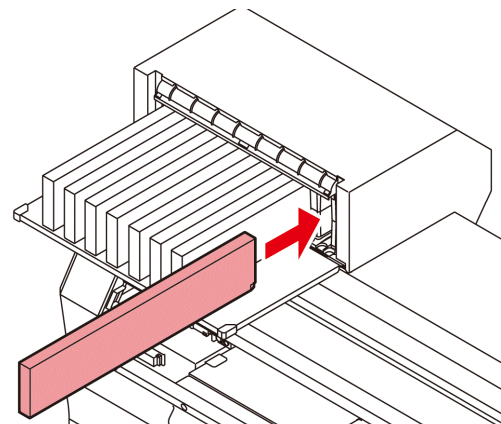

- Colors are displayed on the display as follows.
Black: K, Cyan: C, Magenta: M, Yellow: Y
- For ink cartridge setting order, refer to P.7-5 "Setting orders of ink cartridges".

Changing an ink cartridge

Perform as follows when [INK END] or [INK NEAR END] is displayed on the display.

● When [INK END] is displayed

- (1) Pull out an ink cartridge to be replaced.
- (2) Insert a new ink cartridge, paying attention to the direction of ink IC chip.

● When [INK NEAR END] is displayed

There is a little of ink left. It is recommended to replace the ink cartridge soon since ink may become empty in printing while printing is continuously enabled. When you press the [FUNC1]-[ENTER] key in local mode, you can check the cartridge to be replaced in the information menu.

Important!

- During [INK NEAR END] is displayed, Auto cleaning does not operate. (☞ P.3-9)
- Be sure to change the ink IC chip when you changed the ink pack.

For Ink cartridge lamps

The condition of the ink cartridges set in the machine is confirmable with lamps located over the ink cartridges.

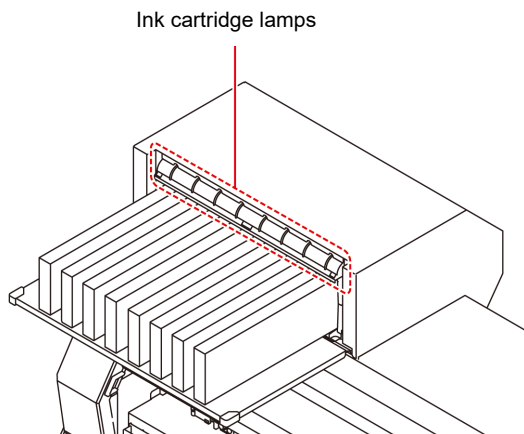

Condition of Lamp	Description
Lit to green	No error (ink is being supplied)
OFF	No error
Lit or blinks to yellow	One of the following errors occurs. <ul style="list-style-type: none"> • Ink near-end • Ink end • Expiration of a term of ink validity (one month)
Blinks to red	Expiration of a term of ink validity (two months)
Lit to red	One of the following errors occurs. <ul style="list-style-type: none"> • No ink left • No ink cartridge inserted • Other ink errors (☞ P.6-7)

Restrictions concerning the product

The ink expiration date is indicated on the Ink cartridge. Expired ink may cause printing defects or alter the color tone. Printing is possible even if the ink has passed its expiration date. Nevertheless, we recommend replacing with new ink or use up as quickly as possible.

Example: The expiration date is April.

May: Replace with new ink or use up as quickly as possible. Printing is possible.

June (Yellow lamp illuminated): Replace with new ink or use up as quickly as possible. Printing is possible.

July (Red lamp flashing): Printing is not possible.



- The message appears on the display.

How to assemble ink cartridge

Before setting the ink cartridge, it is required to set the ink pack on the eco cartridge. By following the next procedures, assemble the ink cartridge.

1 Open the cover of the eco cartridge.

- (1) Press the center part of the cover with your finger.
- The claw on the side without attaching part of ink IC chip comes off.

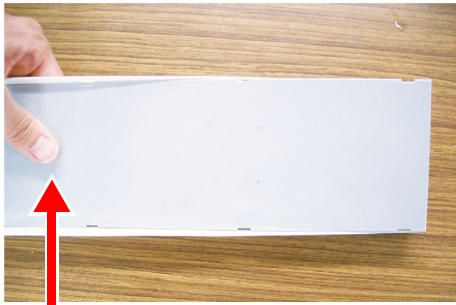

Press the center part with your finger.

- (2) Raise the cover as described in the photo.
- At this time, the claw on the ink IC chip side does not come off.
- Do not raise the cover forcedly so that you may not damage the claw.



- (3) Remove the remaining claw while pressing the cover as indicated in the photo, and remove the cover.

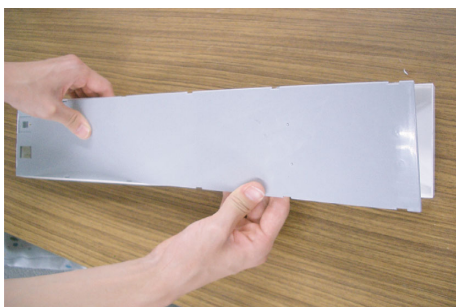

2 Set the ink pack on the eco case.

- (1) Turn the side with double coated tape downward and insert the stopper.
- After inserting the stopper, push it firmly with your finger.



- (2) Peel the seal of double coated tape.



3 Firmly fix the ink pack on the eco case with double coated tape so that it may not move.

- Fix the ink pack after pulling it so that the ink pack may not go slack.



Important!

- Fix the ink pack so that it may not be biased in the eco case.

Good example



The corner of the case matches the ink pack corner.

Bad example



The ink pack has gone too far downward.



The ink pack goes slack in spots.

4 Attach the cover.

- Hang the claw on the ink IC chip side and then insert the cover into the case.



5 Attach the ink IC chip.

- Attach the ink IC chip as indicated in the photo.
- Attach it so that there is no gap in the part indicated with an arrow.

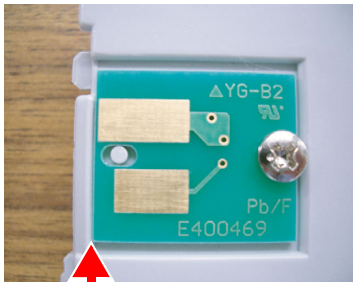

No gap shall be found.

- Bad example of attaching ink IC chip

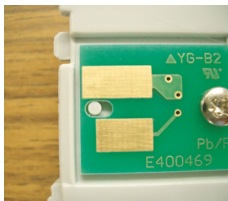

There is a gap.

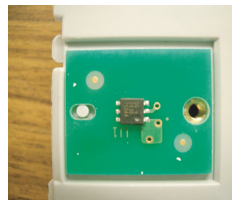

The ins and the outs is reverse.

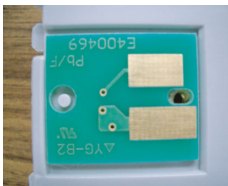

The back and the forth is reverse.

6 Registering weight of eco case.

- Register the eco case weight on this machine to calculate the remaining ink quantity from the weight of the 600 ml cartridge.



Register the weight of the eco case in the following cases.

- For using the 600 ml cartridge for the first time
 - When the case weight is changed by replacing the eco case.
- Important!**
- The weight of each eco case slightly differs respectively. To control accurate ink quantity, be sure to register the weight of each eco case.
 - For details on how to register the weight, refer to P.3-14 "When using 600 ml cartridge for the first time".

Media

Usable media sizes and notes for handling are described.

Usable sizes of media

Model	CJV150-75 BS INK MODEL	CJV150-107 BS INK MODEL	CJV150-130 BS INK MODEL	CJV150-160 BS INK MODEL
Type of Recommended media	Label stock (paper-based) / PVC sheet (including laminated; thickness no more than 0.25 mm) / Reflective sheet (excluding high-luminance reflective sheet) / Heat transfer rubber sheet			
Maximum width	810mm	1100mm	1371mm	1620mm
Minimum width	210mm	210mm	210mm	210mm
Maximum printing width	800mm	1090mm	1361mm	1610mm ^{*1}
Roll media	Thickness	1.0mm or less		
	Roll outside diameter	Φ250mm or less (paper media) Φ210mm or less (others)		
	Roll weight	40kg or less		
	Roll inside diameter	3 or 2 inches		
	Side printed	Side facing outward		
	Roll end treatment	The roll end is gently fixed to the core with weak-adhesive tape or weak glue for easy removal.		

*1. When the MARGIN(RIGHT/LEFT) setting has been set to the minimum (-10 mm).

Caution in handling of medias

Pay attention to the followings for handling of medias.



- Use recommended media.
Use our recommended media to print with stable and high image quality.
- Pay attention to the expansion and contraction of the media.
Do not use media that has just been opened. The media may expand and contract depending on the room temperature and humidity. Open the package and expose it to the place of use for at least 30 minutes before attaching it to the unit.
- Do not use curled media.
In addition to causing media jams, it also affects the image quality.
Also, use media with tight curls after removing the curls. If a regular-sized coated sheet of media is rolled and stored, the coated side has to face outside.
- Be careful to dusts on the edge face of the media.
Some rolls have dusts contained in the package gathered on the edge surface of the roll. If you use as it is, the drawing quality may be degraded due to nozzle missing or ink drops. Be sure to set the roll after removing dusts adhering on the edge face of the roll.
- Be careful to dusts on the edge face of the media.
Some rolls have dusts contained in the package gathered on the edge surface of the roll. If you use as it is, the drawing quality may be degraded due to nozzle missing or ink drops. Be sure to set the roll after removing dusts adhering on the edge face of the roll.

Menu mode

This machine has 4 modes. Each menu mode is described below.

NOT-READY mode

This is the mode in which the media has not been detected yet.

LOCAL mode

Local mode is the mode for the drawing preparation state.

All the keys are effective.

The machine can receive data from the computer. However, it does not perform printing.

Screen display in Local mode

Displays the current heater temperature.

The color of the icon above the temperature display changes with the current heater status.

Orange : Temperature rising

Green : Set temperature reached

Displays the functions that have been set for the function keys [FUNC1] – [FUNC3].

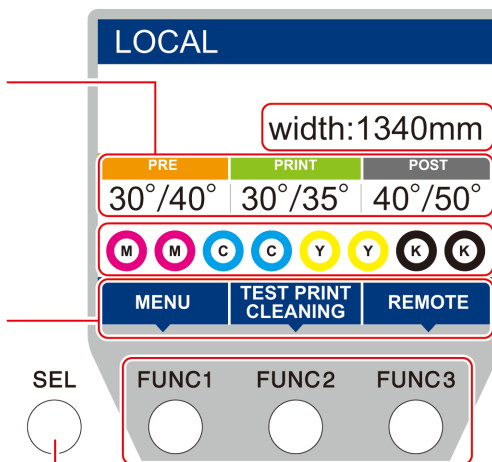

Displays the detected media width.

Displays detected ink levels (approximate)

SEL
[SEL] key

Function key [FUNC1] ~ [FUNC3]
Press the [SEL] key to change the functions.

This mode permits the following operations:

- Pressing the JOG keys to set up a drawing origin and drawing area.
- Pressing the [ENTER] key to check the remaining amount of ink, the description of the cartridge error, the model name, the firmware version, and so on.

MENU mode

To set MENU mode, press the [FUNC1] key when this machine is in LOCAL mode.

In this mode, each function can be set.

REMOTE mode

This machine prints the data it receives.

Chapter 2

Basic Operations



This chapter

describes procedures and setting methods for ink and media preparation, and printing.

Workflow of printing	2-2	Setting of Media Correction	2-21
Turning the Power ON/OFF	2-3	Setting of Media Correction	2-21
Turning the Power ON	2-3	If the Positions of Dots Shift... ..	2-21
Turning the Power OFF	2-3	Printing Data	2-22
Setting a Media	2-4	Starting a Printing Operation	2-22
Adjusting the Head Height	2-4	Stopping a Printing Operation	2-22
Adjusting the Position of the Pinch Roller		Deleting Received Data (Data Clear)	2-22
According to the State of a Media	2-5	Cutting a media	2-22
Maximum Print Area/Cut Area	2-10	Workflow of cutting	2-23
Notes When Using media Holder	2-10	Installing Tools	2-24
Setting a roll media	2-11	When a Cutter Is Used	2-24
Setting the pinch roller pressure	2-13	How to Install a Ballpoint Pen	2-25
Take-up device	2-14	Setting the cutting conditions	2-27
Setting leaf media	2-16	About the Cut Conditions	2-27
Changing the printing origin	2-17	Select the tool condition	2-27
Preparing for the Heaters	2-17	Set the Cut Conditions	2-28
Changing the Temperature Settings for the		Test Cutting	2-29
Heaters	2-17	Cutting Data	2-29
Test Printing	2-18	Setting the origin	2-29
Test Printing	2-18	Start cutting	2-29
Perform test printing with the normal test pattern		Stopping a Cutting Operation (Data Clear)	2-30
.....	2-19	Removing the Cutter Unit Temporarily	2-30
Perform test printing with the test pattern for		Cutting a media	2-30
checking white ink	2-19		
Head Cleaning	2-20		
About head cleaning	2-20		
Perform head cleaning depending on the test			
printing result	2-20		

Workflow of printing

Turning the Power ON/OFF

Referring to “Turning the Power ON/OFF”
(☞ P.2-3).

Setting a Media

Referring to “Setting a Media” (☞ P.2-4).

Preparing for the Heaters

Referring to “Preparing for the Heaters”
(☞ P.2-17).

Test Printing

Referring to “Test Printing” (☞ P.2-18).

Head Cleaning

Referring to “Head Cleaning” (☞ P.2-20).

Printing Data

Referring to “Printing Data” (☞ P.2-22)

Turning the Power ON/OFF

Turning the Power ON

This machine is provided with the following two power switches:

Main power switch :

It is located on the side of this machine. Keep this switch ON all the time.

[END/POWER] key :

Normally, use this key to turn the power ON/OFF.

The nozzle clogging prevention function periodically operates even with the [END/POWER] key turned OFF when the main power switch is turned ON.

1 Turn the main power switch ON.

- Set the main power switch located on the side of this machine to the "I" side.

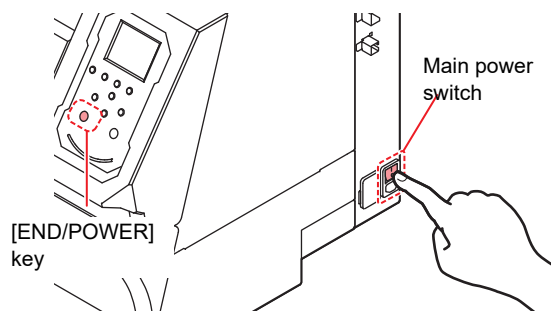

- The firmware version is displayed when the power is turned ON, and the machine performs its initial operation.

2 Turn the power on, by pressing the [END/POWER] key.

- The machine enters LOCAL.

3 Turn ON the power of the connected PC.

Important!

- Turn the power ON after the front cover and maintenance cover are closed.
- The head nozzle may result in nozzle clogging if the main power switch is left OFF for a long time.

Turning the Power OFF

When having ended the operation of the machine, turn the power OFF by pressing the power switch located on the front side.

Check the following items when turning the power OFF.

- If the machine is receiving data from the PC or if there is any data that has not been output yet
- If the head has returned to the capping station
- If any error has occurred
(☞ P.6-7 "Ink Error")

1 Turn OFF the power of the connected PC.

2 Turn the power off, by giving the [END/POWER] key a long press.

- Do not turn OFF the main power switch located on the side of the machine.
- To use this machine again, press the [END/POWER] key .

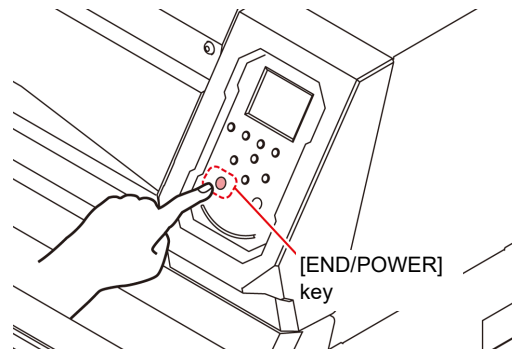

Cautions about Turning the Power OFF

● Do not turn the main power switch OFF.

When the main power switch is ON, the power periodically turns ON and the nozzle clogging prevention function (flushing function) operates. When the main power switch has been turned OFF, the auto maintenance functions, such as flushing, do not operate, and this may cause nozzle clogging.

● Turn the power OFF after having checked the position of the head.

If the power is turned OFF in a state where the head has not returned to the capping station, the ink head dries, which may cause nozzle clogging.

In this case, turn the power ON again and check that the head has returned to the capping station, and turn the power OFF.

● Do not turn the power OFF during printing.

The head may not return to the capping station.

● After having turned the power switch OFF by pressing [END/POWER] key, turn the main power switch OFF.

When turning the main power switch off for moving the machine or for solving the error or the like, press the [END/POWER] key a long time on the front of the machine, check the display is turned off on the operation panel, and turn the main power switch off.

Setting a Media

This machine can be used with a roll media and leaf media.

For usable medias, refer to P.1-12 "Usable sizes of media".

Important!

- Take care not to drop the media on your foot when setting the media. It may cause an injury due to the media.
- When setting a roll media, work by two or more people. Otherwise, you may hurt your back by the weight of the roll media.
- Adjust the head height prior to setting the media. If the head height is adjusted after the media is set, this may cause a media jamming, deterioration of the print quality or head damage.
- The range of the initial head height is adjustable by 2 levels according to the purpose of use.
- The range of the printing height of this machine is from L range (2 mm/3 mm) to H range (3 mm/4 mm). (Set to L range 2 mm at shipping)

Adjusting the Head Height

Adjust the head height according to the thickness of the media you use.

1 Move the carriage to the platen.

- When the device is turned ON :Execute [ST.MAINTENANCE - CARRIAGE OUT] of the Maintenance functions. (P.5-8 Step1,2)
- When the device is turned off : Open the front cover, then move the carriage by hand.

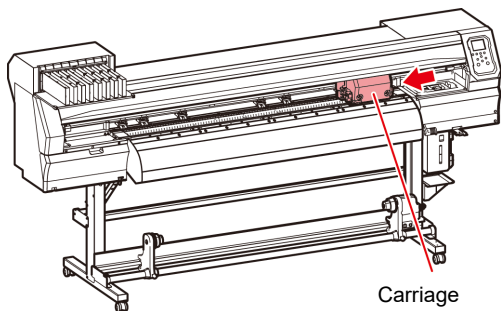

2 Loosen the screw in front.

- Loosen the screws, rotating each by one turn of a standard screwdriver.

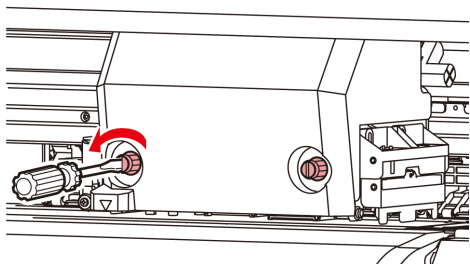

3 Adjust the height-adjusting lever according to the media.

- Adjust the position of the lever, referring to P.2-4 "For the Adjusting Lever and the Range".
- Set the height-adjusting lever to the highest stage or the lowest stage. Setting it to the intermediate height, a printing fault can result.

Height-adjusting lever

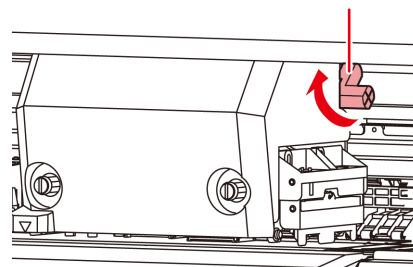

4 Fix the carriage.

- Fasten the screw securely.

Important!

- If you set the height-adjusting lever to the H range or L range, do not push the lever upward or downward when you tighten the screw.

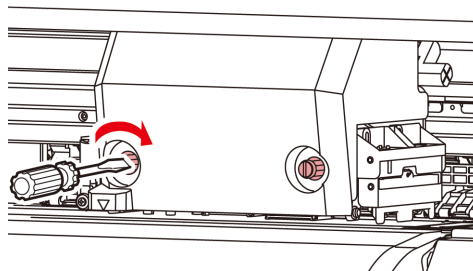

5 Return the carriage to the station position.

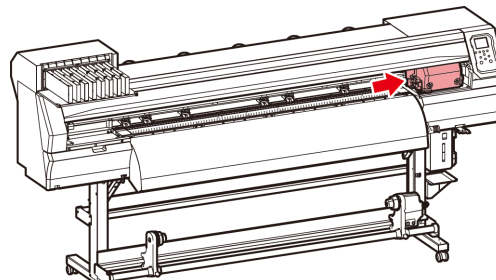

For the Adjusting Lever and the Range

Range	Head height	Note
L range	2mm (The set position at shipping)	You can raise the base of the head height 1 to 2 mm higher. To do this, contact one of our sales representatives.
M range	2.5mm	
H range	3mm	

Adjusting the Position of the Pinch Roller According to the State of a Media

Adjust the position of the pinch roller according to the width of the media to be set.
This machine feeds the media with a pinch roller and grid roller for printing or cutting.
The pinch roller should be above the grid roller.



- When setting the media, do not place the pinch roller that has been removed from the media on the grid roller. (Move the pinch roller as shown in the illustration "X" in "How to Adjust the Pinch Roller".) Operating the printer with the media not gripped between the pinch roller and grid roller could wear the pinch roller out.

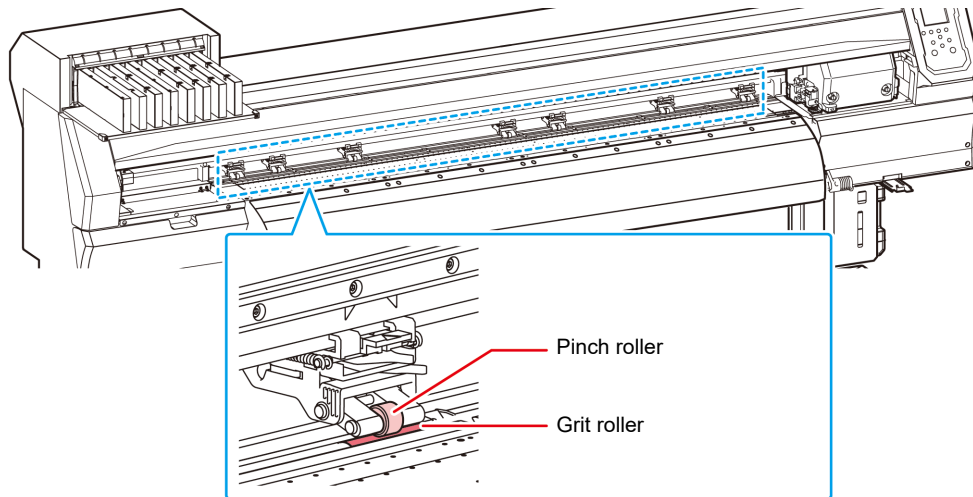

How to Adjust the Pinch Roller

Move the pinch roller unit to adjust the position of the pinch roller.
Use the pinch roller guide mark for positioning.

To adjust the pinch roller
from the front side:

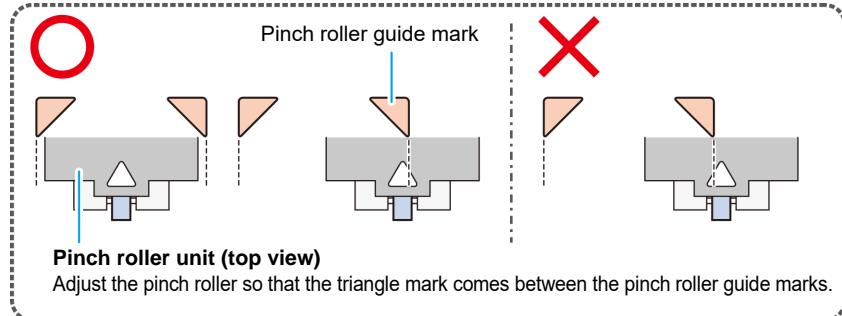

To adjust the pinch roller
from the rear side:

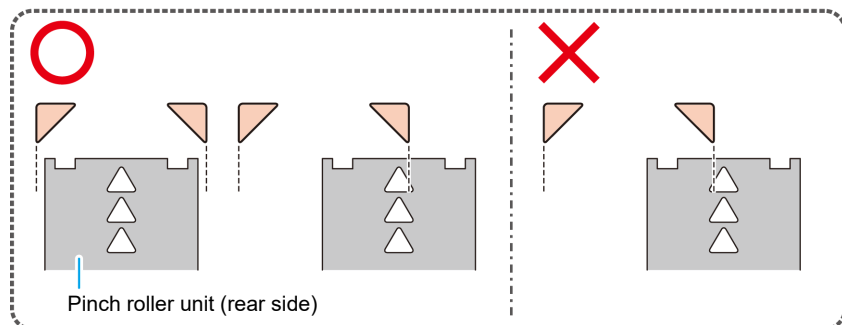

Media Size and the Grit Roller (CJV150-160 BS INK MODEL)

The grit roller positions are determined by the size of the media.

Important!

- To feed the media smoothly, select the grid roller positions so that the media can be held at equally spaced intervals.
- When the grid rollers to be used are determined, adjust the pinch roller unit referring to "How to Adjust the Pinch Roller" of P. 2-17.
- You can use any number of pinch roller units from 2 to 7.
- Adjust the pinch roller of both ends so that they are within the range of 10cm from media left end and 2cm from media right end. If adjusting them to the further position, it will remain uncut when cutting the media.

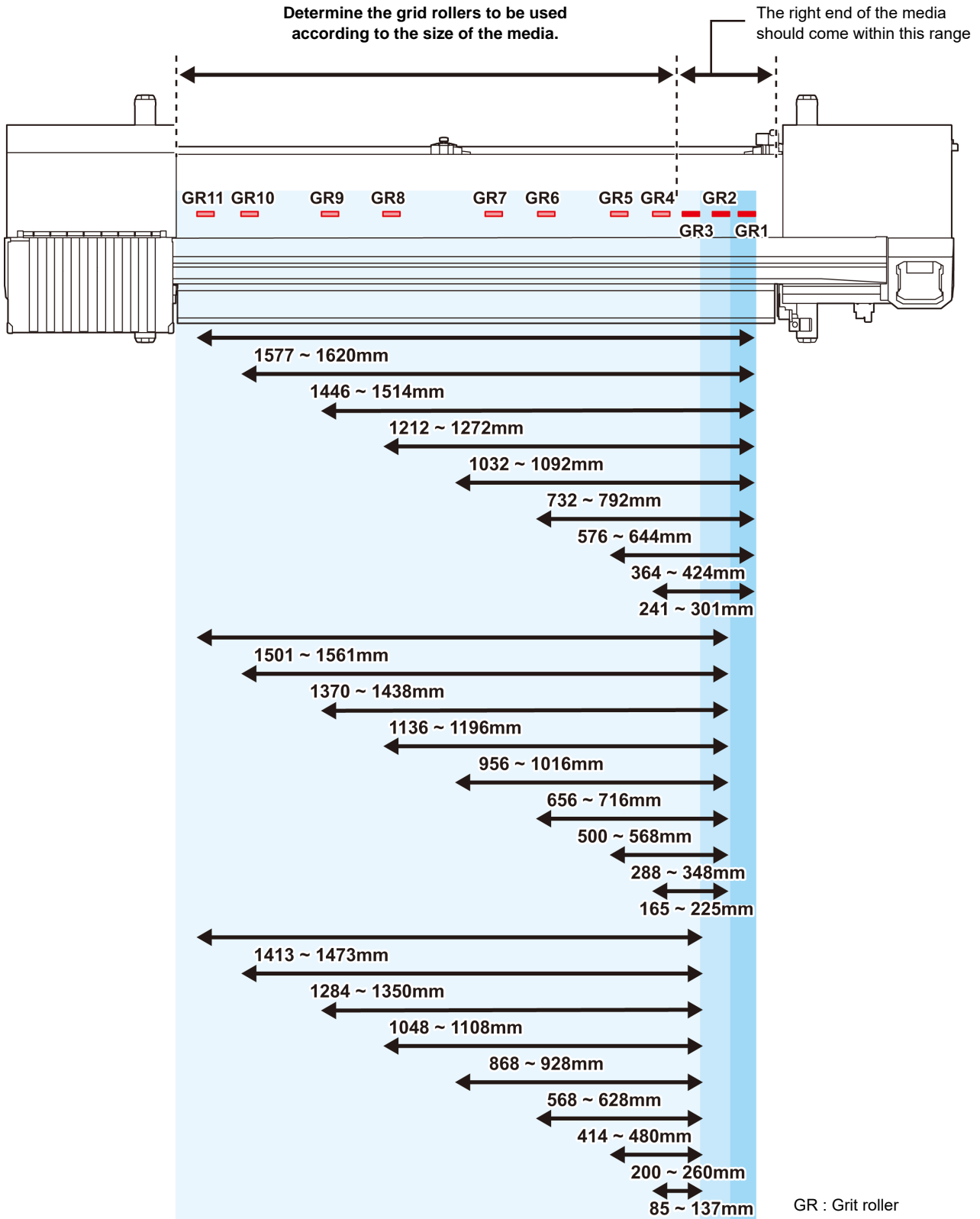

Media Size and the Grit Roller (CJV150-130 BS INK MODEL)

The grit roller positions are determined by the size of the media.

Important!

- To feed the media smoothly, select the grid roller positions so that the media can be held at equally spaced intervals.
- When the grid rollers to be used are determined, adjust the pinch roller unit referring to "How to Adjust the Pinch Roller" of P. 2-17.
- You can use any number of pinch roller units from 2 to 6.
- Adjust the pinch roller of both ends so that they are within the range of 10cm from media left end and 2cm from media right end. If adjusting them to the further position, it will remain uncut when cutting the media.

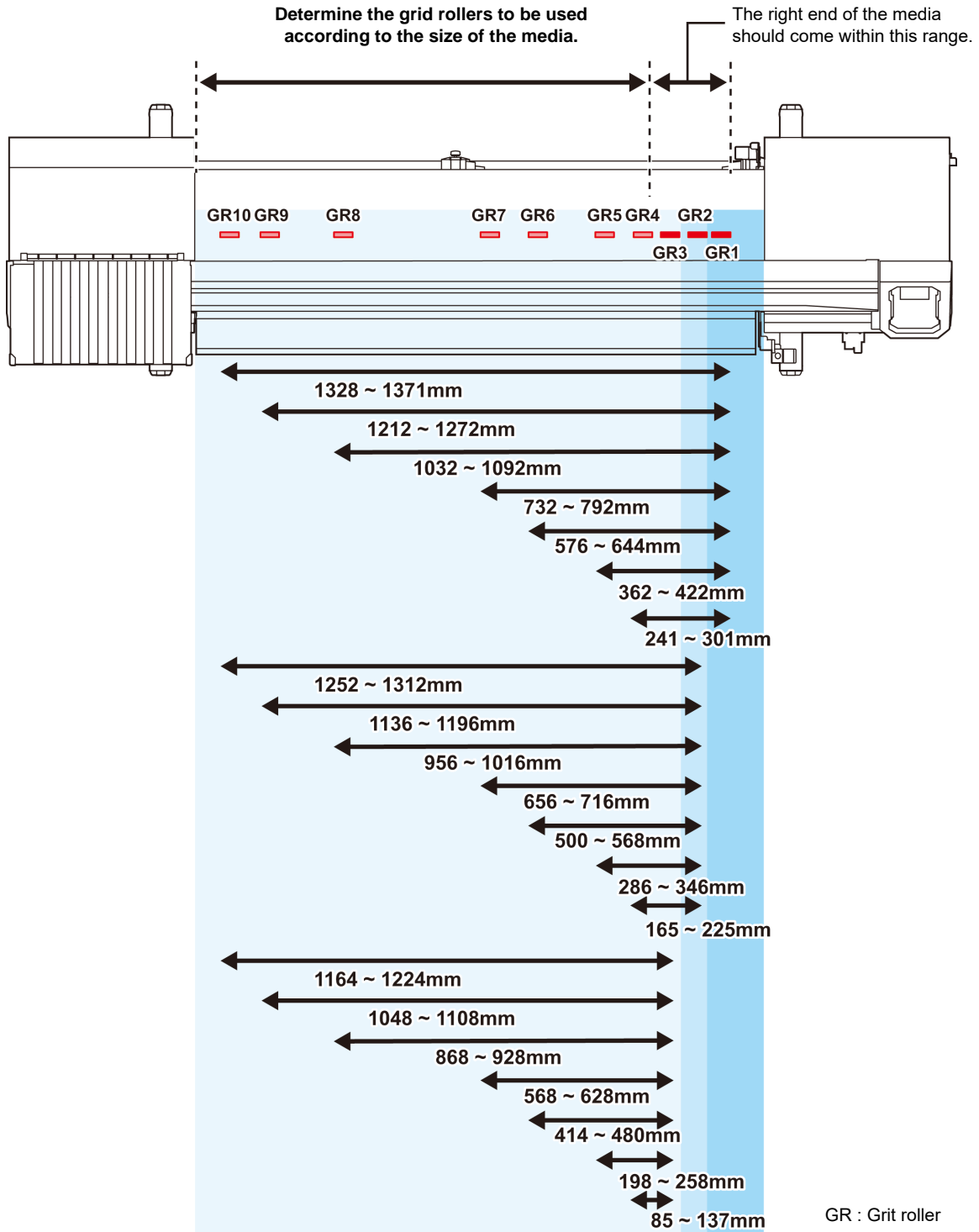

Media Size and the Grit Roller (CJV150-107 BS INK MODEL)

The grit roller positions are determined by the size of the media.

Important!

- To feed the media smoothly, select the grid roller positions so that the media can be held at equally spaced intervals.
- When the grid rollers to be used are determined, adjust the pinch roller unit referring to "How to Adjust the Pinch Roller" of P. 2-17.
- You can use any number of pinch roller units from 2 to 5.
- Adjust the pinch roller of both ends so that they are within the range of 10cm from media left end and 2cm from media right end. If adjusting them to the further position, it will remain uncut when cutting the media.

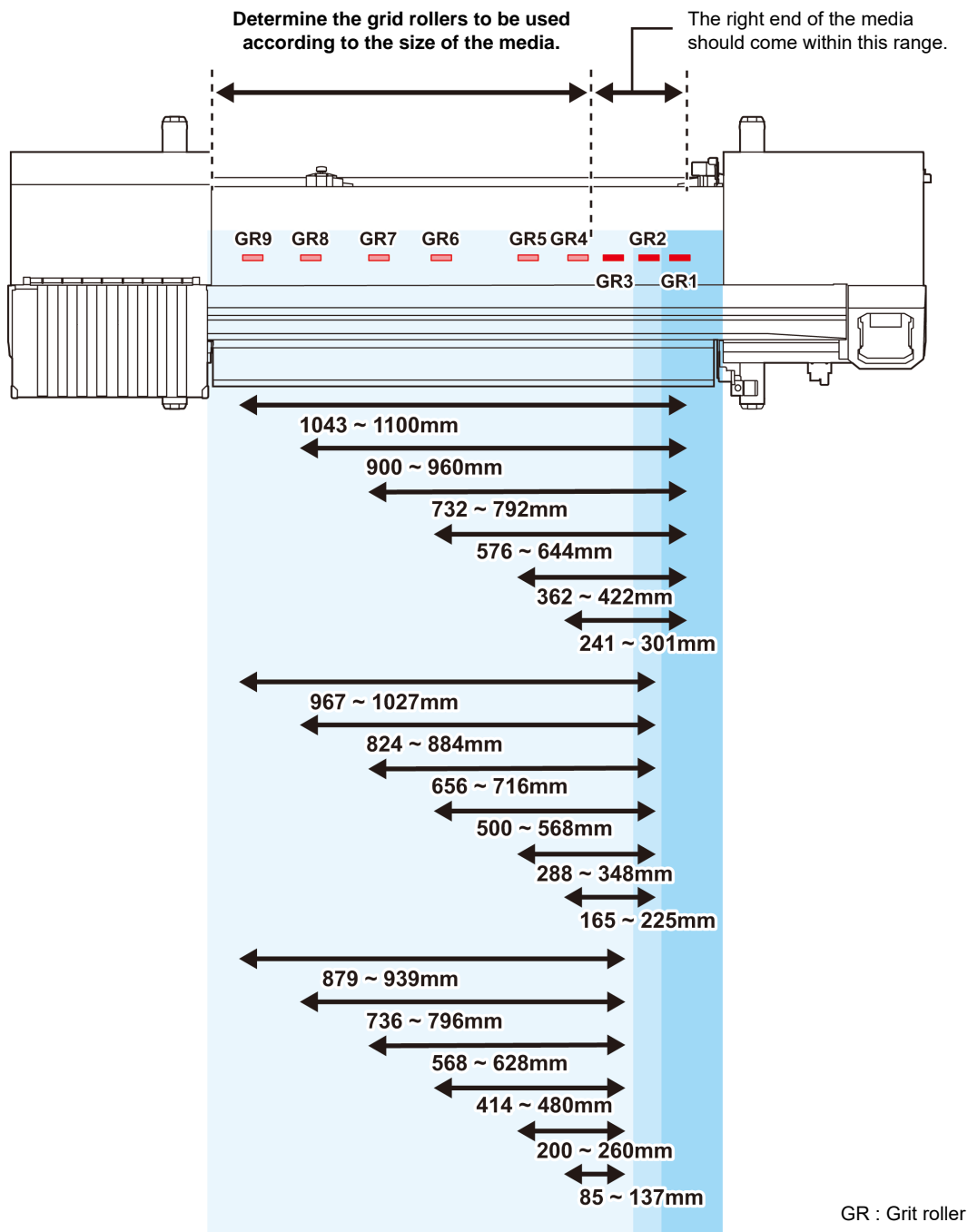

Media Size and the Grit Roller (CJV150-75 BS INK MODEL)

The grit roller positions are determined by the size of the media.

Important!

- To feed the media smoothly, select the grid roller positions so that the media can be held at equally spaced intervals.
- When the grid rollers to be used are determined, adjust the pinch roller unit referring to "How to Adjust the Pinch Roller" of P. 2-17.
- You can use any number of pinch roller units from 2 to 4.
- Adjust the pinch roller of both ends so that they are within the range of 10cm from media left end and 2cm from media right end. If adjusting them to the further position, it will remain uncut when cutting the media.

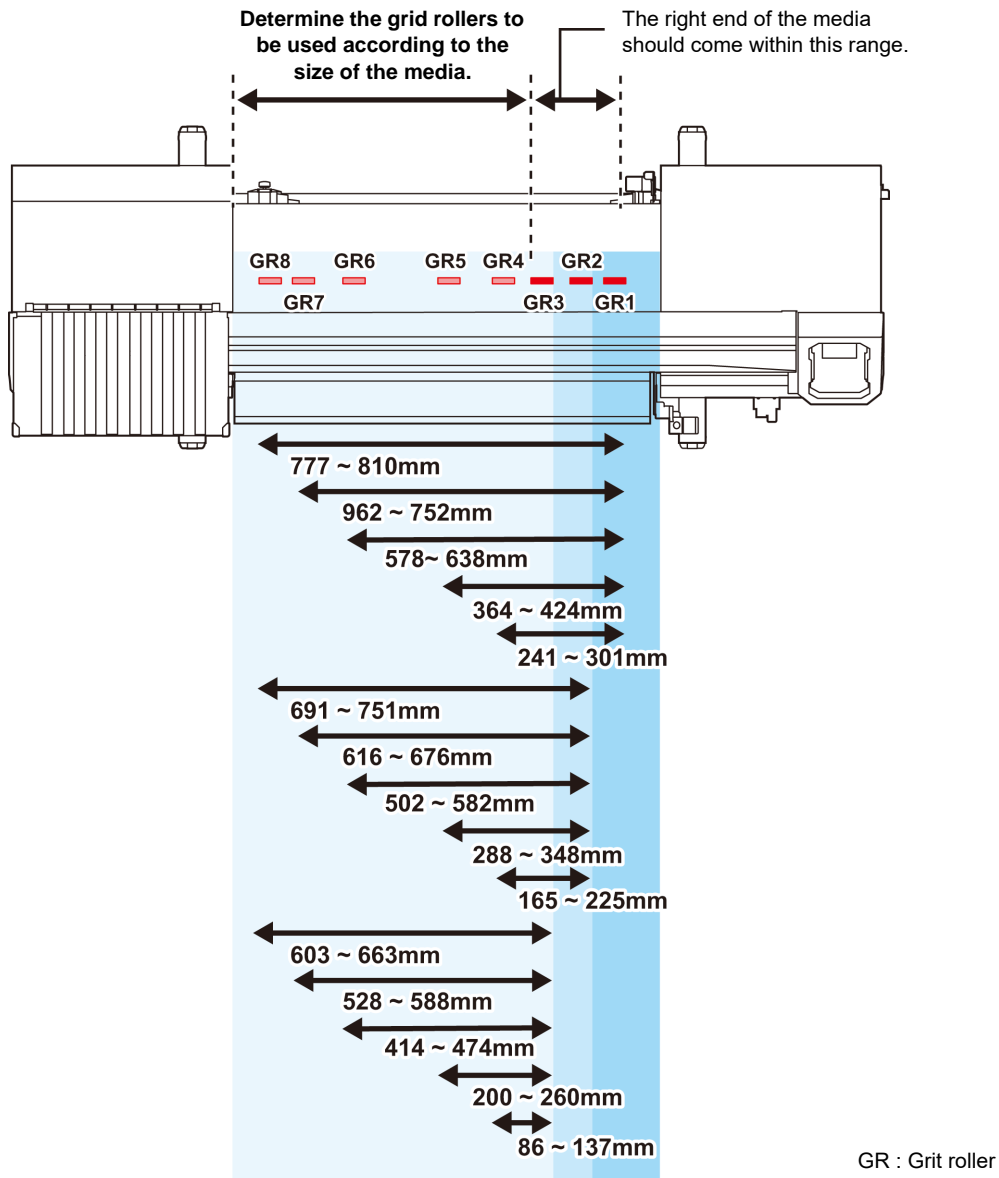

Maximum Print Area/Cut Area

The maximum printed area/cut area varies, depending on the position of the pinch roller (P.2-6 to) and the origin position (P.2-17). The white area shown in the following figure represents the maximum print/ cut area. The area other than that is the dead space that cannot be printed/cut.

	CJV150-75 BS INK MODEL	CJV150-107 BS INK MODEL	CJV150-130 BS INK MODEL	CJV150-160 BS INK MODEL
Maximum printing/cut width	800mm	1090mm	1361mm	1610mm

Notes When Using media Holder

Setting Position of the Media

Set the media so that the right end of the media will be inside the area shown below.

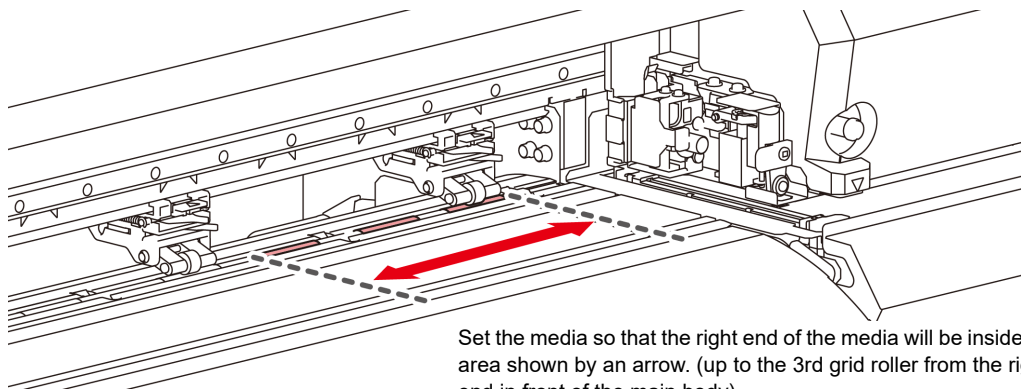

Set the media so that the right end of the media will be inside the area shown by an arrow. (up to the 3rd grid roller from the right end in front of the main body)

The End of the Media Should Not Exceed the Slit Line on the Platen

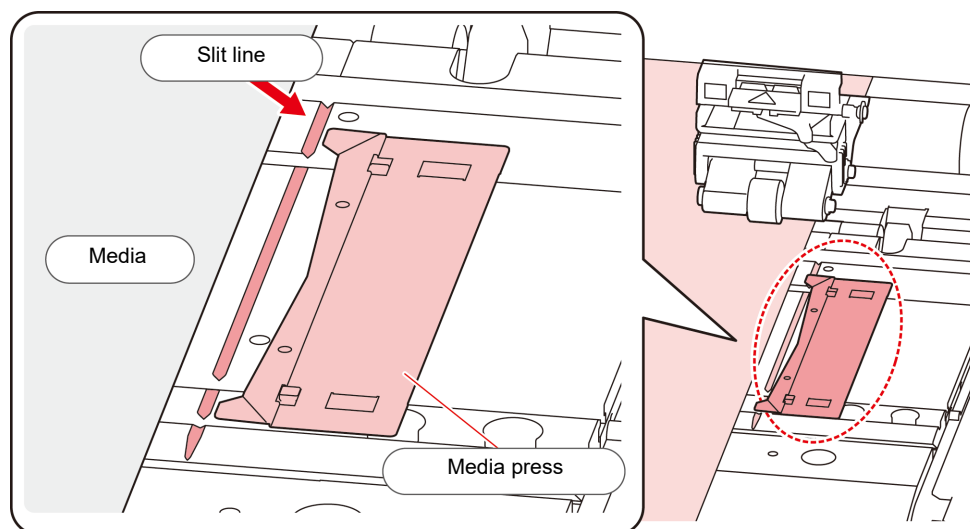

Setting a roll media

Set a roll media to the roll media hanger located on the back of this machine.



- Take care not to drop the media on a foot or so when the media is set. It may cause an injury due to the media.

1 Move the roll holder located in the back of the device to the direction of the middle of the device.

- Loosen the roll holder fixing screw and move it.

2 Check the clamp lever is lowered.

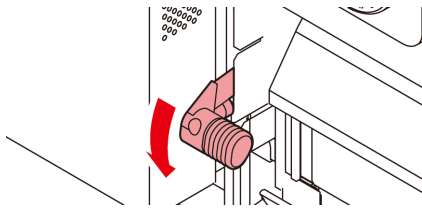

3 Move the roll holder to the roll setting position.

- Check the media size and the position to set the media, referring to the section applicable to your machine (P.2-18 to P.2-21).

Adjust the basic position of the roll holder so that it is placed between the guide marks of the pinch rollers.

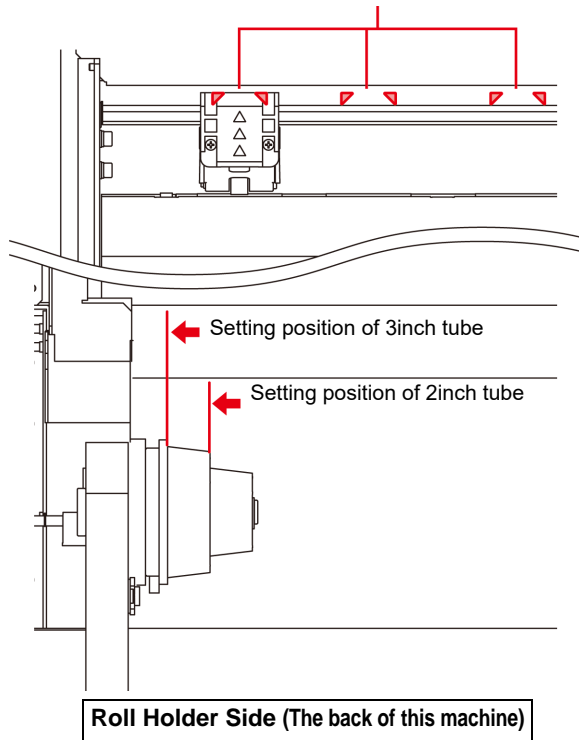

4 Tighten the roll holder fixing screw.

- Check the Step 2 to 3 again.

5 Set the left end of the core of the roll media on the left roll holder.

- Push the roll media onto the roll holder until the roll core is all the way seated.

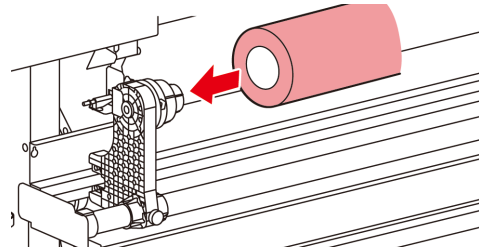

6 Loosen the screw of the right side roll holder then insert the holder into the core of the roll media.

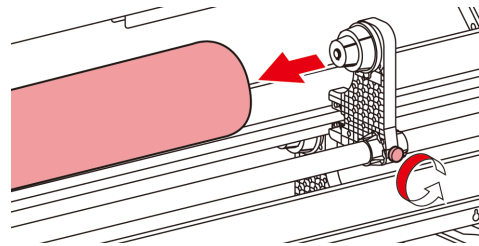

7 Raise the clamp lever in the rear of this machine.

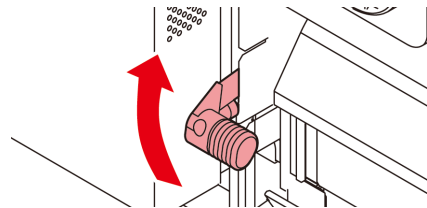

8 Insert the roll media in this machine.

- The roll media can be smoothly inserted by slanting the media.

- (1) Pull the media out of the roll to the head of the platen.
- (2) Insert the media between the platen and the pinch roller.
 - Pull the media out of the roll so that the media can be grasped from the front of the machine.
- (3) Push down the clamp lever from the back of this machine.
 - The media is held.



- Set the pinch roller units so that the media can be held at equally spaced intervals. If the pinch rollers cannot be set at equally spaced intervals, start over from Step 3.
- Ensure there is a dead space of 5 mm or above at each end of the media. (P.2-10)

9 Pull out the roll media out.

- (1) Open the front cover.
- (2) Raise the clamp lever from the front of this machine.
- (3) Pull out the roll media gently and stop pulling when locked lightly.

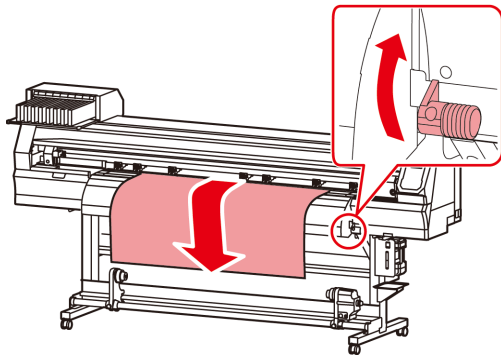

10 Make the roll media even then lower the clamp lever.

- Pulling several positions of the media lightly, Lower the clamp lever after confirming that the amount of the roll media pulled out is almost even.

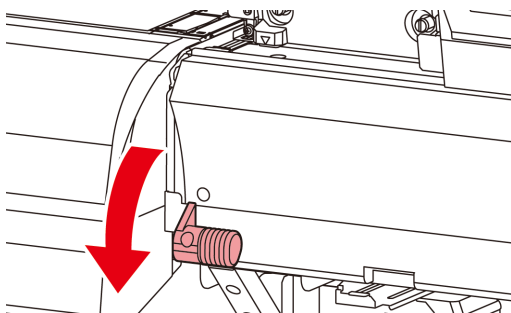

11 Hold the media with the media press gently.

- Set the media so that no media sticks out from the right end pinch roller to the right side.
- When using a thick media, remove the media press from the media before printing.
- Do not use the media holder when cutting media.

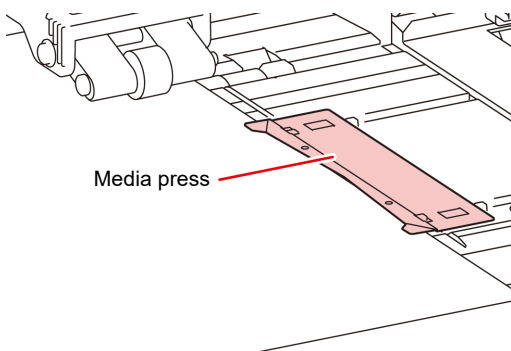

- When installing the media, align the media's right edge with the slit line in the platen. Placing the media rightward of the slit line will make it rise up if it moves obliquely, and this could cause damage to the head.
- If a media is misaligned to the right/left more than fixed position, a error message "MEDIA SET POSITION R" is displayed. Set the media again.

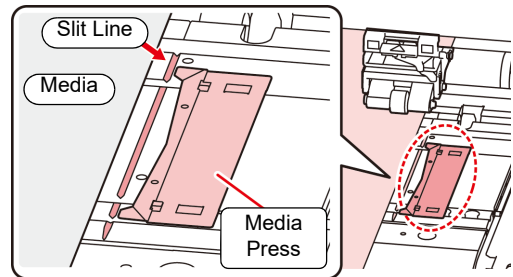

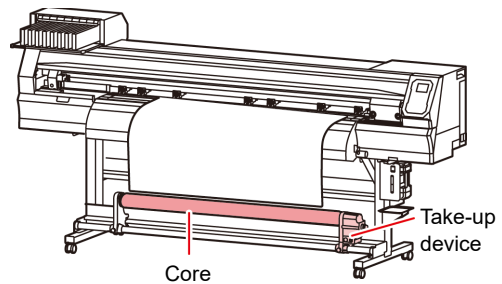

12 Set an empty core of the roll media on the take-up device.





13 Press the  key to select "ROLL" .

- Detects the media width.
- When [MEDIA DETECT] of the machine setup is "MANUAL" ( P.3-13), refer to P.2-13 "Setting of the manual media width setting" and enter the media width.

14 When the media width detection is complete, use   to enter the number of the pinch rollers you are using.

- When the pinch roller number in "MEDIA DETECT" of the machine setup is set to OFF ( P.3-13), the screen to enter the number of pinch rollers is not displayed. Proceed to step 16.

15 Press the  key.

- When [MEDIA RESIDUAL] of the machine setup is "ON" ( P.3-13), the screen for entering media remaining amount is displayed after pressing [ENTER] key. ( P.2-13)

16 Secure the media on the take-up device. (☞ P.2-14)

- (1) Feed the media up to the core of the roll media of the take-up device by pressing the [▼] key.
- (2) Fix the middle of the media with adhesive tape.
- (3) In the same manner, fix the left side and right side of the media.
 - Make sure that there is no slack or wrinkle on the media in such condition that the roll media is pulled to right and left evenly, and stick the tape.

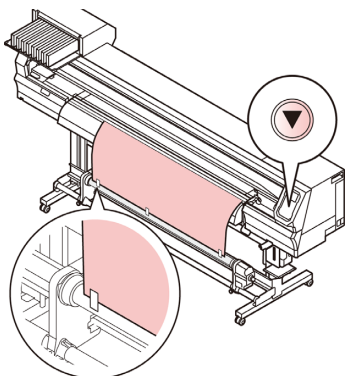

Setting the pinch roller pressure

After setting the media in place, set the pressure of the pinch rollers that retain the media.

Be sure to set a pressure value that is appropriate for the media. With an inappropriate pinch roller pressure value, the media could skew during printing or cutting, or the pinch rollers could remain on the media after pinching.

You can set the following items in pinch roller pressure settings:

Item	Setting value	Outline
NUMBER FOR USE	1 ~ 7	Set the number of the pinch rollers you are using. This number differs depending on the model you are using.
PRINT	LOW/ MID/ HIGH	Set the pinch roller pressure for printing.
CUT: ENDS	LOW/ MID/ HIGH	Set the pressure of the edge pinch rollers (left and right edges) used when cutting the media.
CUT: INNER	OFF/ LOW/ MID/ HIGH	Set the pressure of the pinch rollers except for the edge pinch rollers used when cutting the media.
CHANGE EXECUTION	PRINT/ CUT	Switch between the setting for printing and cutting.

- 1 Press the **[FUNC3] (PR)** key in LOCAL.
- 2 Press **[▲] [▼]** to select setting item, and press the **[ENTER]** key.
- 3 Press **[▲] [▼]**, to select the setting value.
- 4 Press the **[ENTER]** key.
- 5 Press **[▶]**, to end the setting.
 - If you want to switch to another setting immediately, press [**<**].

Individual setting of pinch roller pressure

The intermediate pinch roller can be set individually according to the media used.

- 1 Press the **[FUNC3] (PR)** key in LOCAL.
- 2 Press **[▲] [▼]** to select setting item, and press the **[ENTER]** key.
- 3 Press the **[FUNC2]** key.
- 4 Press **[▲] [▼] [◀] [▶]** and **[FUNC3]** to set the respective pinch roller pressure.
- 5 Press the **[ENTER]** key.
- 6 Press the **[END/POWER]** key several times to end the setting.



- When printing, set all pinch roller pressures to the same value.
- When cutting, set the pinch roller pressure at both ends to the same value.
- For details, please refer to [P&C Pinch roller / Register Mark Configuration Guide] (D202830).

Entering the media remaining amount

When [MEDIA RESIDUAL] of the machine setup is "ON" (☞ P.3-13), the screen for entering media remaining amount is displayed after detecting the media width.

- 1 Display the screen for entering media remaining amount.

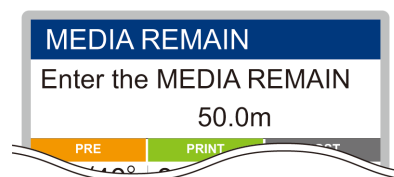

- 2 Press **[▲] [▼]** to enter the media remaining amount.
- 3 Press the **[ENTER]** key.

Setting of the manual media width setting

When [MEDIA DETECT] of the machine setup is "MANUAL" (☞ P.3-13), set the media width in the following method.

- 1 Display the screen for entering the right edge position of the media.

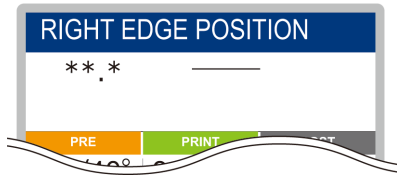

2 Press **▲▼** to enter the right edge position of the media.

3 Press the **ENTER** key.
 • Next, the screen to enter the left edge position of the media is displayed.

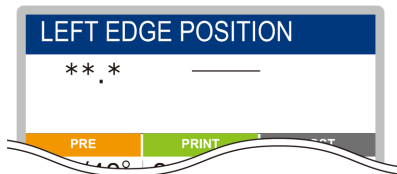

4 Press **▲▼** to enter the media the left edge position of the media.

5 Press the **ENTER** key.

Important! • Be careful not to set the position beyond the media range, as it may cause printing or cutting outside the media.

About the media residual print

When [MEDIA RESIDUAL] of the maintenance function is "ON" (P.3-13), You can print a list of print the current date and media remaining.

1 In Local, Press **▲▼◀▶**.
 • It enters into the origin setting mode.

2 Press the **FUNC3** key.
 • Appear the confirmation screen of media remaining print.

3 Press the **ENTER** key.
 • Media residual print starts.

Take-up device

With the switch of the narrow take-up device, select the take-up direction of the media or others.

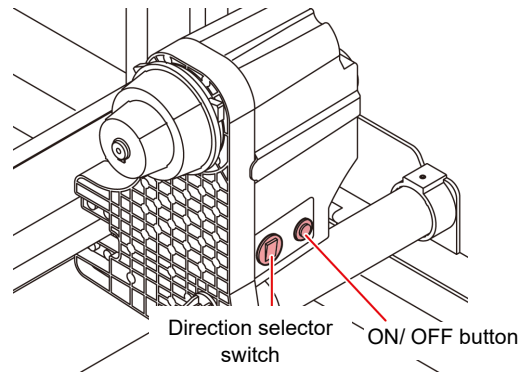

Direction selector switch	UP (REVERSE)	The take-up device winds the media with the printed side facing in.
	DOWN (FORWARD)	The take-up device winds the media with the printed side facing out.
ON/OFF button	Turns the winding motion on/off. (When you press the button and operate the take-up device, the device keeps taking up the media until you press the button again. *1)	

*1. You can also change the setting so that the taking-up operation only lasts while the ON/OFF button is being pressed. For details, refer to "Setting Take-up unit" (P.3-12) in machine settings.

Setting the torque limiter

The take-up device is provided with a torque limiter. The take-up torque can be adjusted with the torque limiter. (The torque limiter is set to "media" at delivery.) If the tension is too strong to use a thin media of media, lower the take-up torque with the torque limiter.

Clockwise turn :

Increases torque (a heavy and thicker media such as tarpaulin or the like)

Counterclockwise turn :

Decreases torque (For light media)

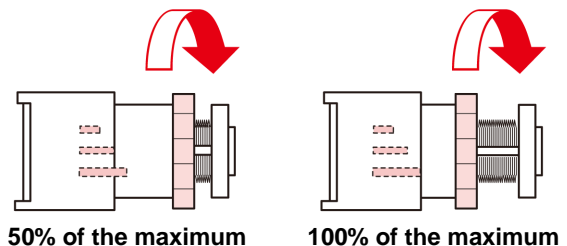
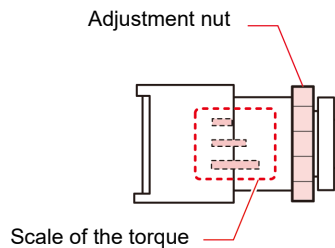

When Not Using Taking-up Device



- When performing printing or cutting of 700 mm or more without using the taking-up device, evacuate the takingup device to right and left. The quality of the print and cut may become low because of the impact when the front end of the media touches the taking-up device.

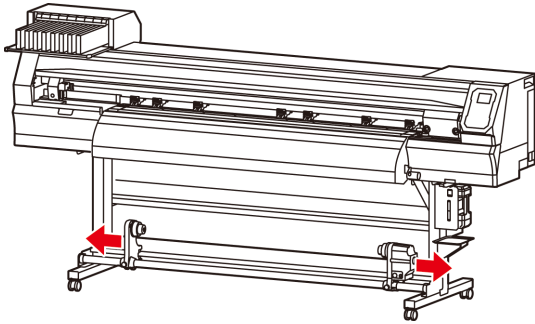

Setting leaf media

Unlike roll media, leaf media does not need to be retained with the roll holders.

1 Raise the clamp lever.

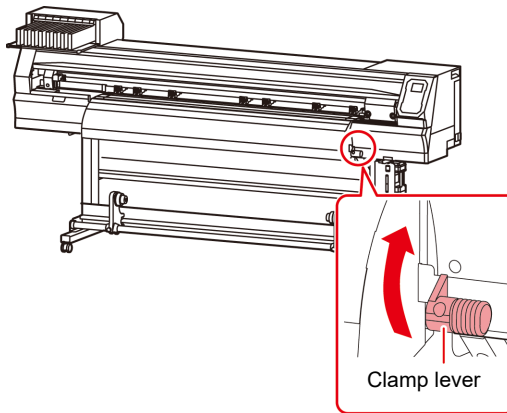

2 Insert the leaf media between the platen and the pinch rollers.

- Set the media so that no media sticks out from the right end pinch roller to the right side.

3 To print, hold the media with the media press gently.

- Set the media so that no media sticks out from the right end pinch roller to the right side.
- When using a thick media, remove the media press from the media before printing.
- Do not use the media holder when cutting media.

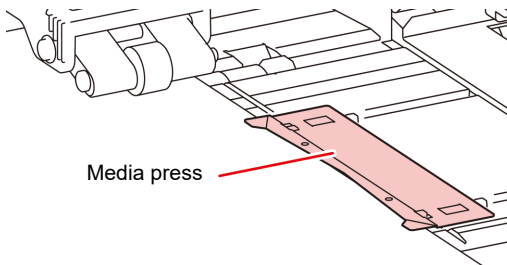

- Set the pinch roller so that the media is held at equally spaced intervals. If the pinch rollers cannot be set at equally spaced intervals, start over from Step 2.
- Ensure there is a dead space of 5 mm or above at each end of the media. (P.2-10).

4 Push down the clamp lever.

- Set the media straight.

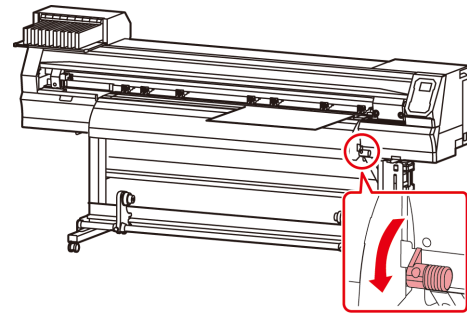

Important!

- Set the media on the black part of the platen so that it comes out approximately 40mm. If it is shorter than that, it may not be able to perform the media detection.

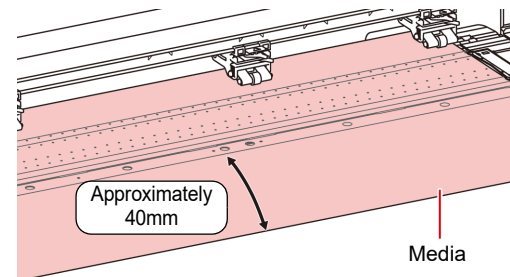

5 Press the **ENTER** key.

6 Press the **▶** key to select "LEAF" .

7 The media detection is started.

- (1) The media width is detected.
- (2) The media is fed then the rear end of media is detected.
- (3) It returns to the Local when the detection is completed.



- After setting the media in place, set the pinch roller pressure, referring to P.2-13 "Setting the pinch roller pressure".

Notes when using media press





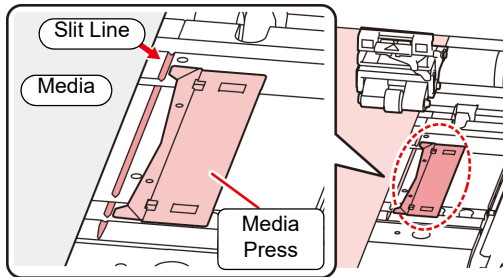

- When installing the media, align the media's right edge with the slit line in the platen. Placing the media rightward of the slit line will make it rise up if it moves obliquely, and this could cause damage to the head.
- If a media is misaligned to the right/left more than fixed position, a error message "MEDIA SET POSITION R" or is displayed. Set the media again.



Changing the printing origin

The position of the printing origin can be changed. Moving the LED pointer to the changing position and deciding the position.



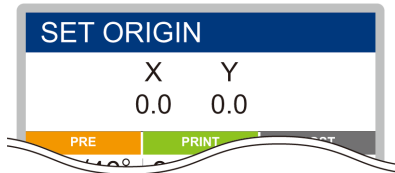

- 1 In Local, Press    .



- It enters into the origin setting mode.



- 2 Set a light point of the LED pointer to the changing position by pressing



- Select the carriage and media, moving the point with [][][][].

- 3  After determining the origin, press the  key.

- The printing origin is changed.

Typical setting position of printing origin

The printing origin in the depth direction (X') is positioned at about 75 mm rearward from the slot for cutting on the platen. The printing origin in the scanning direction (Y') is positioned at 15 mm from the right end of the media. The value in the scanning direction (Y') can be changed using [MARGIN] in FUNCTION mode. (P.3-8) This can be changed by using the Jog key.

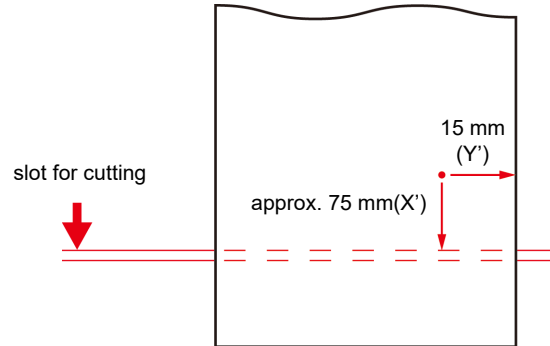

Preparing for the Heaters

Changing the Temperature Settings for the Heaters

You can change/save the temperature settings for the heaters with "Heater" of the setting mode. (P.3-6) Here, changing method of the temperature set in the setting mode is explained.

Set the heater temperature according to the characteristics of the media you use.

The temperature of the heaters has been set to "OFF" as default.





Appropriate temperature adjustment can be made because the temperature can be adjusted even during printing.

It may take several minutes to tens of minutes for the set temperature to be reached, depending on the ambient temperature.

- 1 Press the  key, and press the  (Heater) in LOCAL.

- The heater temperature adjustment screen will be displayed.

- 2 Press     to set the temperature of each heater.

Heater selecting: Select with [][]
Temperature setting: Set with [][]

- The heater starts to get hot.

- 3 The heating of the heater stops.

- When the heater temperature reaches the set temperature, the heater icon lights in green.

- 4 Press the  key to stop heating.

- The screen returns to LOCAL.

Test Printing

Print a test pattern to check that there are no discharging defects such as nozzle clogging (slight touching of ink or nozzle missing).

Relationship between head row and test pattern

The relations between head row and test pattern print position are as follow.

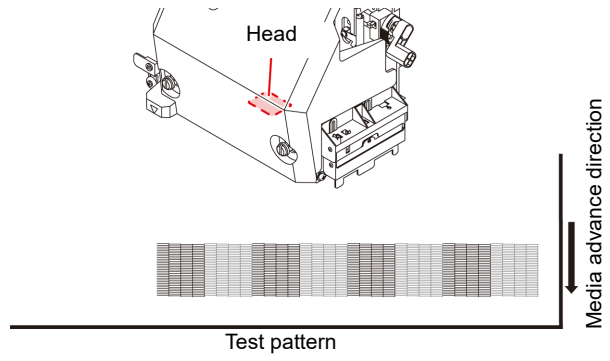

About test patterns

This machine provides you two test patterns.

● Normal test pattern (when using ink other than white ink)

When you use ink that you can check by printing a test pattern on a white media, print this test pattern.

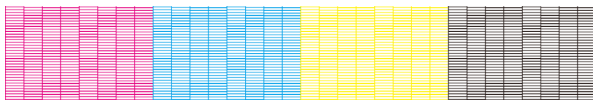

● Test pattern for checking white ink

When you use a white media and wish to check discharging status of white ink, print this test pattern.

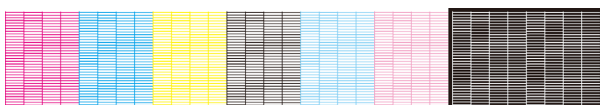

Note on test printing

Important!

- When using leaf media, set a media of more than A3 size put horizontally. If a media with narrow width is set, printing will only be conducted to midway.
- When using a roll media, rewind the media by hand before printing so that it is not loose. When the roll media has not been rewound tightly, it may cause image quality to deteriorate.

Test Printing

Print a test pattern to check that there are no discharging defects such as nozzle clogging (slight touching of ink or nozzle missing).

In addition, you can select the orientation of the test pattern to print from two types in order to perform test printing repeatedly. Select one depending on your use.

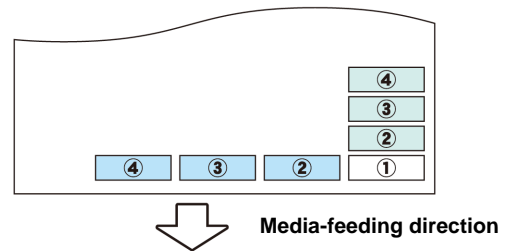

- : When the set value is "FEED DIR."
- : When the set value is "SCAN DIR."

Check before test printing.

- If a media has been set (👉 P.2-4)
- If the origin position has been set
- If the head gap has been adjusted (👉 P.2-4)

Perform test printing with the normal test pattern

- 1** Press the **FUNC2** (TEST PRINT/CLEANING), and press the **ENTER** key in LOCAL.
 - TEST PRINT MENU will be displayed.
 - Press [▲][▼] to change the test pattern orientation. The orientation selected here will be reflected on when you will print next time.
 - When performing test printing after having changed the orientation from "SCAN DIR." to "FEED DIR.", the line is fed to the position of the first test printing.
- 2** Press the **ENTER** key.
 - Test printing starts.
 - When the printing has been completed, the screen returns to LOCAL.
- 3** Check the printed test pattern.
 - When the result is normal, end the operation.
 - When the result is abnormal, perform head cleaning. (☞ P.2-20)

Normal pattern

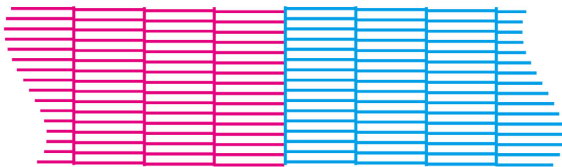

Abnormal pattern

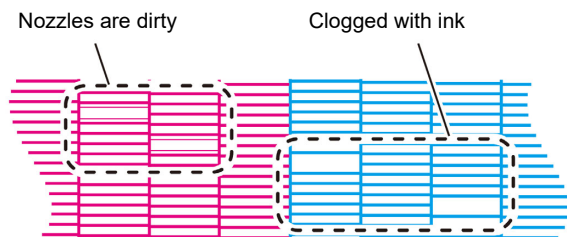

Perform test printing with the test pattern for checking white ink

It makes easier to check if print the background to the white ink locations in the pattern.

- 1** Press the **FUNC2** (TEST PRINT/CLEANING), and press the **ENTER** key in LOCAL.
 - TEST PRINT MENU will be displayed.
- 2** Press **▲▼** to select "SpotColor Check".
- 3** Press the **ENTER** key.
 - Print a test pattern in the following orders.
 - (1) Print the pattern daubed with black.
 - (2) Dry the pattern for thirty seconds.
 - When press the [ENTER] key, cancel waiting time and shift to step (3).
 - (3) Return the media automatically and print the test pattern.
- 4** Check the printed test pattern.
 - When the result is normal, end the operation.
 - When the result is abnormal, perform head cleaning. (☞ P.2-20)

Normal pattern

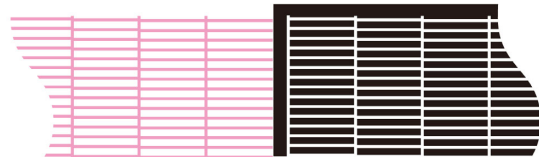

Abnormal pattern

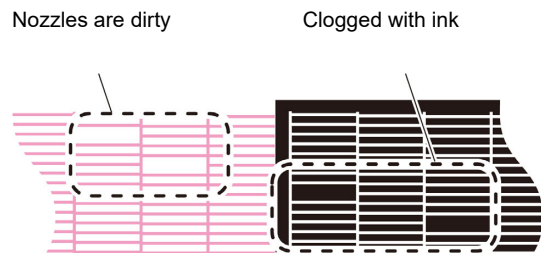

Head Cleaning

About head cleaning



Check the printed test pattern result and perform cleaning depending on the status.

Select one from the four types below:

- NORMAL** : When any line is missing
SOFT : When only head wiping is needed (when lines are bent)
HARD : When poor image quality cannot be improved even by NORMAL or SOFT cleaning
ULTRA : When poor image quality cannot be improved even by HARD cleaning



Perform head cleaning depending on the test printing result

There are four types of head cleaning. Use one by checking the test pattern.

- 1** Press the **FUNC2** (TEST PRINT/CLEANING)  **ENTER** key in LOCAL.
 - CLEANING MENU will be displayed.
- 2** Press   to select the cleaning type.
 - **NORMAL** : Select this if any line is missing.
 - **SOFT** : When only head wiping is desirable. (in case of bent lines)
 - **HARD** : Select this if inferior printing cannot be improved even by [NORMAL] or [SOFT] cleaning.
 - **ULTRA** : Select this if inferior printing cannot be improved even by [HARD] cleaning.
- 3** Press the **ENTER** key.
- 4** Perform test printing again, and check the result.
 - Repeat the cleaning and the test printing until the printing result becomes in normal.



When the image quality is not improved after the head cleaning.

- Clean the wiper and ink cap. ( P.5-8)
- Wash the head nozzle. ( P.5-9)

When 600ml cartridge is used

- **Even when [Ink Level] is displayed, enough ink for head cleaning may remain in the ink pack.**

When [Ink Level] appears, see P.3-15 “When [Ink Level low] is displayed” and enter the current weight of the 600ml cartridge.

- **When the remaining ink is not enough for head cleaning**

When the remaining ink is not enough for head cleaning, an error message “Error” shown on the step 3. Replace with a new ink pack, and then perform head cleaning again.

Setting of Media Correction

Correct the media feed amount to match the type of media you are using.

If the correction value is not appropriate, stripes may appear on the printed image, thus resulting in a poor printing.



- On completion of [MEDIA COMP.] during use of a roll media, the media returns to the printing origin. Then the roll media in the rear of this machine will slacken. Before printing, take up the slack in the roll media by hand; a loose roll media can result in an inferior image quality.
- When printing with a take-up device, set the media first and perform media correction.

Setting of Media Correction

A pattern for media correction is printed and a media-feeding rate is corrected.



- Two bands are printed in the correction pattern.
- Make adjustment so that an even color density is obtained in the boundary between the two bands.

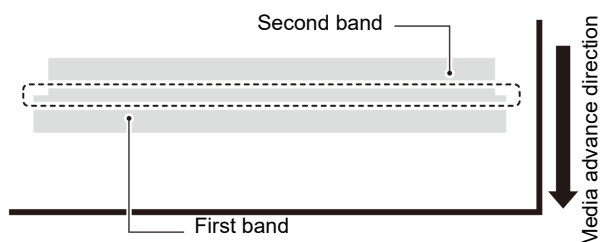

1 Set a media. (☞ P.2-4)

2 Press the **[SEL]** key, and press the **[FUNC2] (ADJUST)** in LOCAL.

- ADJUST MENU will be displayed.

3 Press the **[ENTER]** key twice to print the correction pattern

4 Check the correction pattern and enter a correction value.

- A screen for entering the correction value will be displayed.
- **Enter a correction value in "+":**
The boundary between the two bands is widened.
- **Enter a correction value in "-":**
The boundary between the two bands is narrowed.
- When you change the correction value by "30", the width of the boundary changes by about 0.1 mm.

If the Positions of Dots Shift...

When the condition for printing (media thickness/ink type/ etc.) has been changed, perform the following operation to correct the ink drop position for bidirectional (Bi) printing and obtain the proper printing result.



- When using leaf media, set a media of more than A3 size put horizontally. If a media with narrow width is set, printing will only be conducted to midway.

Example of a Printed Pattern

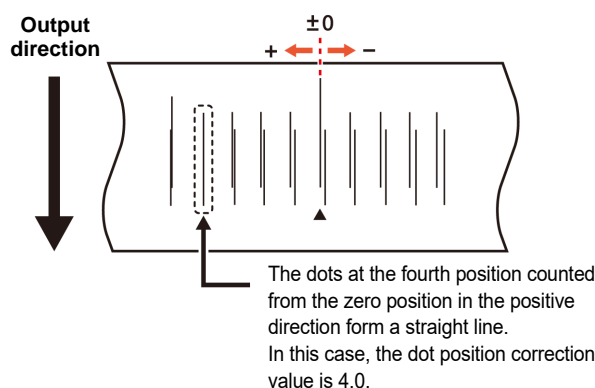

1 Press the **[SEL]** key, and press the **[FUNC1] (ADJUST)** in LOCAL.

- ADJUST MENU will be displayed.

2 Press **[▼]**, and press the **[ENTER]** key.

- "DROP.POScorrect" will be selected.

3 Press the **[ENTER]** key.

- Printing of the Drop position correct printed pattern will start.
- Multiple test patterns are printed. (The printed patterns are called Pattern 1, Pattern 2, Pattern 3... in the order of printing.)

4 Press **[▲]****[▼]** to enter a correction value of Pattern 1, and press the **[ENTER]** key.

- Corrected feeding rate: -40 to 40
- Check the test patterns. The position where an outward feeding line and a return feeding line become one straight line is the correction value.
- When the correction value is not between -40 and 40, adjust the height of the printing heads and perform the operations in Step 2 and later.

5 In the same way as in Step 4, enter a correction value of Pattern 2 and later, and press the **[ENTER]** key.

6 Press the **[END/POWER]** key several times to end the setting.

Printing Data

Starting a Printing Operation

Important!

- When using a roll media, rewind the media by hand before printing so that it is not loose. When the roll media has not been rewound tightly, it may cause the image quality to deteriorate.

1 Setting a Media (🔗 P.2-4)

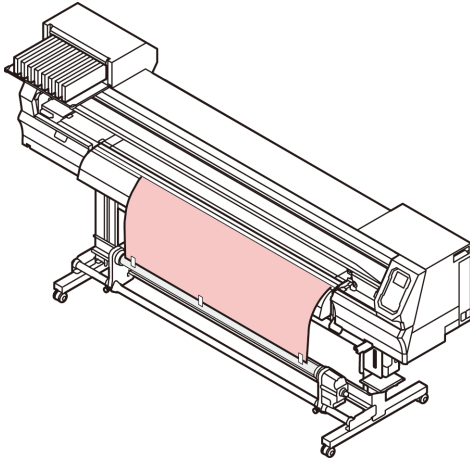

2 Press the **FUNC3 (REMOTE)** key in LOCAL.

- The screen changes to REMOTE, and data can be received from the PC.

3 Transmit data to be printed from the PC.

- For the method of data transmission, see the instruction manual for the output software.

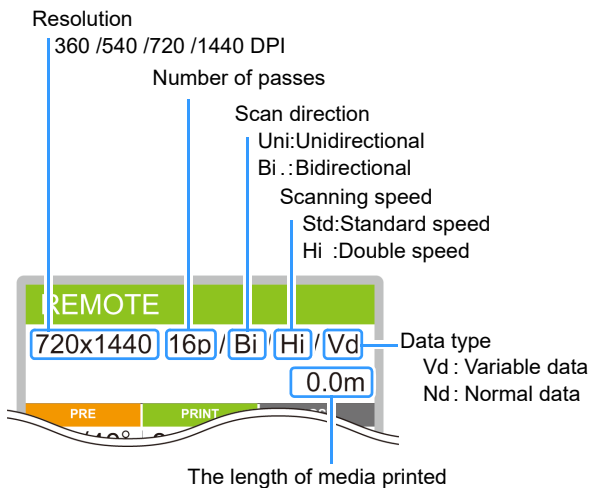

4 Start printing.

- The printing speed may change, depending on the width of the set media or the position of the print origin even when the same data is printed. This is because of a difference in resolution.

Stopping a Printing Operation

Perform the following operation when stopping a printing operation halfway.

1 Press the **FUNC3 (LOCAL)** during printing.

- The printing operation stops.
- Interrupt data sending at the PC side during the data is sent from the PC.
- Printing restarts from the interrupted data by repressing the [REMOTE] key.

Deleting Received Data (Data Clear)

When you want to stop printing, delete the already received data.

1 Press the **SEL** key, and press the **FUNC3 (DATA CLEAR)** in LOCAL.

2 Press the **ENTER** key.

- The received data is erased then it returns to the Local.

Cutting a media

By using the keys on the operation panel, you can cut the media at any position.

1 In Local, Press **▲▼◀▶**.

- It enters into the origin setting mode.
- By pressing [▼], feed the media to the cutting position.

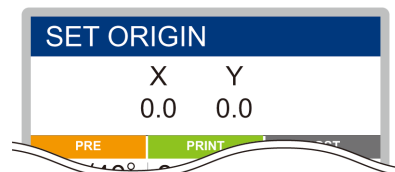

2 Press the **FUNC2 (ENTER)** key.

- The media is cut.
- When the cutting has been completed, the current mode returns to LOCAL.

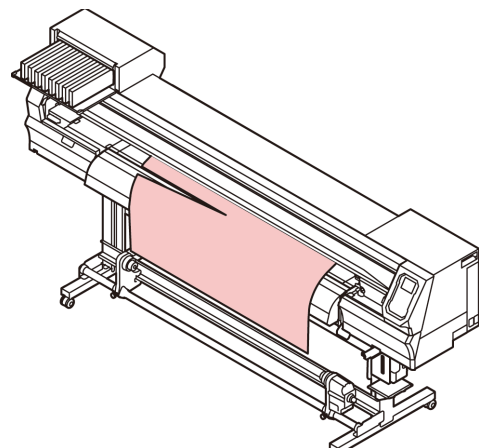

Workflow of cutting

Turning the Power ON/OFF

Referring to “Turning the Power ON/OFF”
(☞ P.2-3).

Setting a Media

Referring to “Setting a Media” (☞ P.2-4).

Installing Tools

Referring to “Installing Tools” (☞ P.2-24).

Setting the cutting conditions

Referring to “Setting the cutting conditions”
(☞ P.2-27).

Test Cutting

Referring to “Test Cutting” (☞ P.2-29).

Cutting Data

Referring to “Cutting Data” (☞ P.2-29).

Installing Tools

This machine allows you to use the following tools:

Cutter :

This tool is selected when an image printed on a media is cut or when letters are cut with a cutting media.

Pen (water-based ballpoint pen) :

This tool is used to perform "test printing" for checking how images or letters are cut actually.

When a Cutter Is Used



- **Do not touch the cutter with your fingers.**
The sharp blade edge of the cutter may cause you to get injured.
- **Do not shake the tool after having set the cutter.**
Otherwise, the blade edge may pop out, causing you to get injured.
- Store the cutter blade in a place that is out of the reach of children. In addition, dispose of used cutter blades according to regional laws and regulations.

How to install a cutter

- 1 Remove the cap located at the edge by rotating it, and replace the cutter with a new one using tweezers or the like.

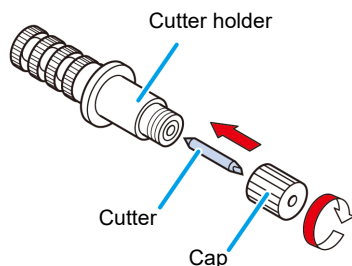

- 2 Turn the adjusting knob to adjust the protruding amount of the cutter.

- arrow to protrude the cutter blade.
(0.5 mm per revolution)

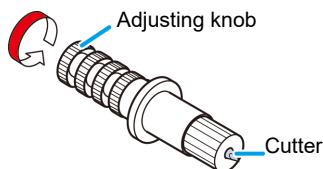

Adjusting the protrusion of the cutter blade

Adjust the cutter blade according to the types of the cutters and the sheet for use.

After adjusting the protrusion of the cutter blade, set the cutting conditions and conduct test cutting to check the cutting quality. For the cutter supplied with unit, the protruding amount of the blade can be adjusted with the cutter mounted in the pen carriage.

Important!

- Take care not to protrude the blade too much. If the cutter is used with its blade excessively protruded, the cutter can cut out the base paper, thus damaging the main unit.

- 1 Turn the adjusting knob to adjust the protruding amount of the cutter blade.

- arrow to protrude the cutter blade.
(0.5 mm per revolution)

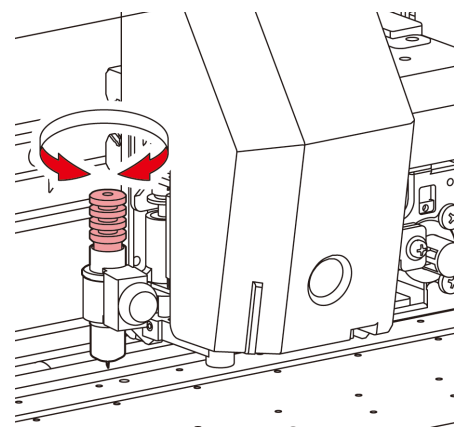

Important!

- See the appendix for the blade adjustment of the cutters other than the auxiliary products.
(P.5-21)

Protruding amount of the cutter blade

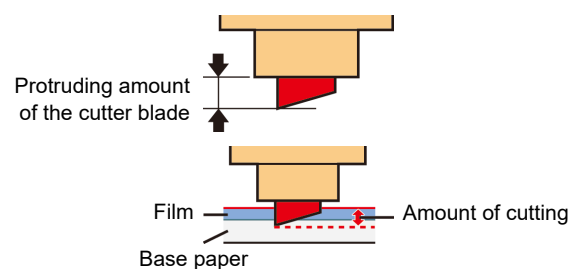

$$\text{Amount of cutting} = \frac{(\text{Film thickness} + \text{Base paper thickness})}{2}$$

- However, Film thickness < Base paper thickness

For reference :

the protruding amount of the cutter blade = 0.2 to 0.5mm
(Replace the blade when it is blunt.)

Important!

- Adjust the blade pressure so that the cutter may leave a little bit of cutter track on the sheet.
- In case the sheet thickness is thinner than the film thickness, which may not provide correct cutting quality, change the protruding amount of the blade and you may get a better result.

How to install the cutter holder

- Important!** • Install the cutter holder to the tool holder of the carriage. Be sure to insert the cutter holder all the way in the tool holder.

1 Press the **FUNC1 (MENU)** → **FUNC3 (>>)** → **ENTER** key in **LOCAL**.
• Cuttbg MENU will be displayed.

2 Press **▲▼** to select “**TOOL REPLACE**”, and press the **ENTER** key.

3 Press the **ENTER** key.
• The cutter unit moves to the left end of the machine.

4 Rotate the knob to loosen the holder presser.

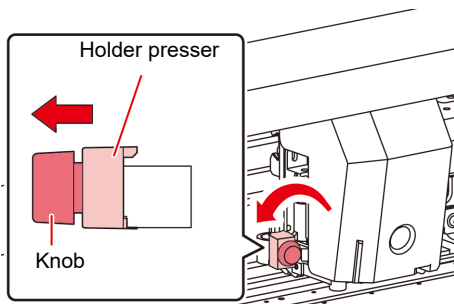

5 Insert the cutter holder into the tool holder.
• Push the brim of the cutter holder against the tool holder.
• Press the brim of the cutter holder with the holder presser.

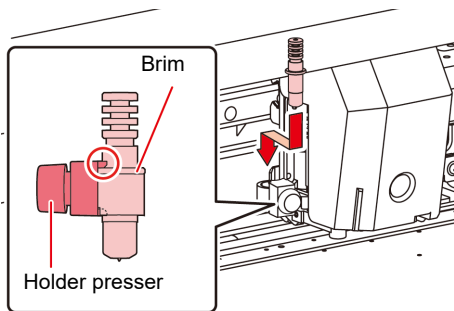

6 Fix the cutter holder.
• Turn the knob of the tool holder clockwise, and surely fix it.

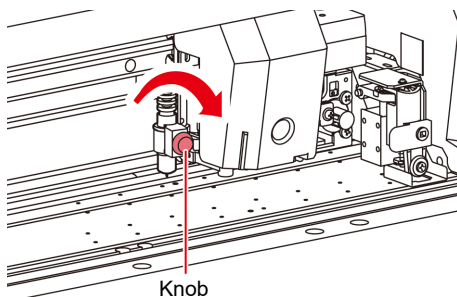

- Important!** • Fix the cutter holder firmly. If not, accurate and high-quality cutting will not be achieved.

How to Install a Ballpoint Pen

- Important!** • When you want to use a commercially available ballpoint pen, you must use the pen of 8mm to 9mm in diameter. Image quality may depend on the pen. (Recommended ballpoint pen: the one available from Pentel Co., Ltd. with the product No.: K105-A, K105-GA)
• Regarding such ballpoint pens as shown below, the pen inclines to touch the cover when held by the pen adapter (the pen that the pen holder girth of which may vary, the pen that the pen holder of which has umbo and differences)

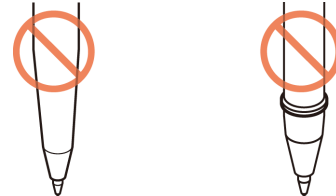

Uneven gauge

With steps or bumps

1 Put the cap on the pen adapter.
• Use the cap to adjust the pen height.

2 Insert the pen into the pen adapter.
• Insert the pen until the tip of the pen reaches the cap.

3 Fix the tip of the pen.
• Tighten the fixing screw clockwise.
• Be careful not to over-tighten the fixing screw for the pen adapter. If tightened too much, the ballpoint pen may crack.

4 Remove the cap.

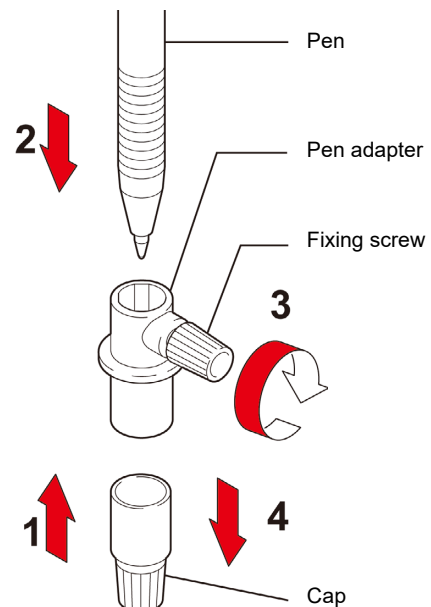

5 Press the **FUNC1 (MENU)** → **FUNC3 (>>)** → **ENTER** key in **LOCAL**.
• Cuttbg MENU will be displayed.

6 Press **▲▼** to select “TOOL REPLACE”, and press the **ENTER** key.

7 Press the **ENTER** key.
 • The cutter unit moves to the left end of the machine.

8 Rotate the knob to loosen the holder presser.

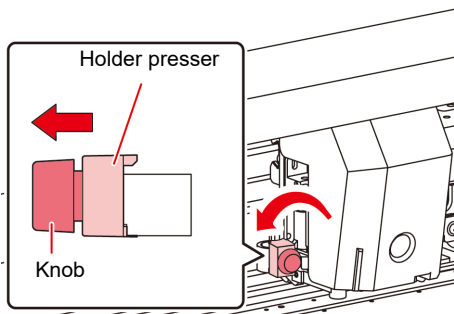

9 Insert the pen adapter with the pen into the tool holder.

- Make sure that the brim of the pen adapter is rested on the tool holder.
- Set the adapter in such a way that the fixing screw will not obstruct operation.
- Press the brim of the pen adapter with the holder presser.

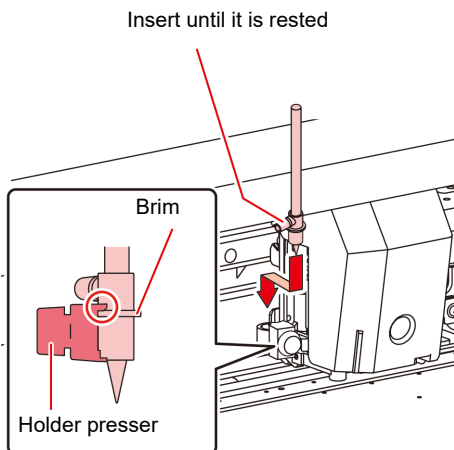

10 Turn the knob clockwise to fix the tool.

- Turn the knob of the tool holder clockwise, and surely fix it.



- Instead of the ballpoint pen, you can attach the refill that comes with it. Follow the procedure below to attach the ballpoint pen refill to the pen adapter, then put it into the tool holder in the same way as in step 6.

(1) Insert a spring into the pen tip.

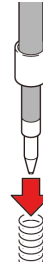

(2) While pressing the cap onto the spring, attach it on the pen adapter.

- Rotate the cap to the direction indicated with an arrow and attach it on the pen adapter.

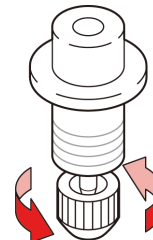

Important!

- When you replace the ballpoint pen (SPB-0726), contact a distributor in your district or our office to call for service

Setting the cutting conditions

You can register the cutting speed and the pressure depending on the sheet or the tool type to be used. (Cut condition)

About the Cut Conditions

Items you can set here

Tool condition	You can select the cutting condition No.(1 to 7) or plotting condition (PEN).
Cut speed	Setting of the speed of cutting.
Cut press	Setting of the pressure required for cutting. (g)
Offset *1	Setting of the distance from the center of the cutter holder to the cutter blade.
Half cut *2	Setting of enabling (ON)/disabling (OFF) the half-cut function.
Half cut press	Setting of the pressure of left part. (g)
H-leng	Setting of the length to be left (not to be cut). (mm)
C-leng	Setting of the length to be cut. (mm)

- *1. You cannot set this when "PEN" is selected in the tool condition,
*2. The three items in the lower level are available when the half-cut is set to ON.

About Selecting Cutting Condition

- 1 Press the **(SEL)** key to display "TOOL" in LOCAL.

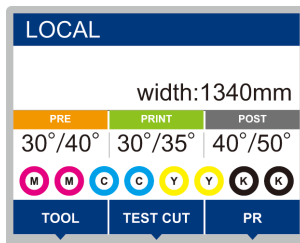

- 2 Press **(FUNC1)** to display the cut condition.
 - The three items shown in the following screen are not displayed unless the half-cut is set to ON.

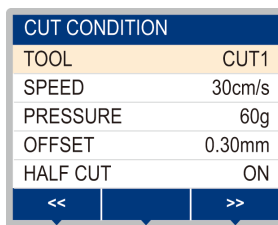

(FUNC3)

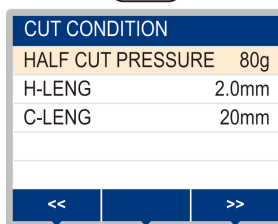

About Half Cutting

You can cut on the dotted line, not to cut sheet out. (Half cut)

When you set half cut to valid (ON), you can use the half cut function.

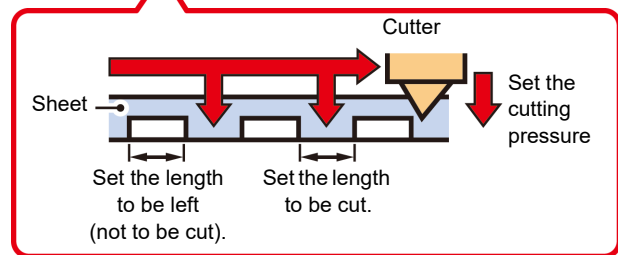
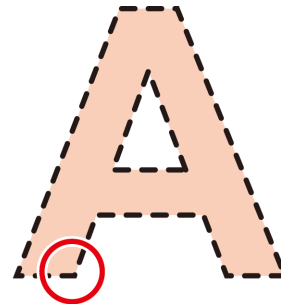

(Important!)

- The illustration above is the image. The shape of cut surface differs depending on the cutting conditions.

Select the tool condition

Before cutting (plotting), select the tool condition depending on the sheet and the tool type to be used.

- 1 Press the **(SEL)** key in LOCAL to display the "TOOL" menu.
- 2 Press the **(FUNC1)** (TOOL).
- 3 Press the **(ENTER)** key.
- 4 Press **(▲)****(▼)** to select a tool condition to be used.
 - Each time you press **(▲)****(▼)**, the tool condition is switched as follows.

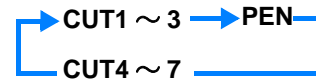

- 5 Cutting.

Set the Cut Conditions

Set the condition to cut or to plot with a pen.

Setting contents of cutting condition (CUT1 to 7):

Cut speed (SPEED)/ cut pressure (PRESS)/ OFFSET value/ Half cut

Setting contents of plotting condition (PEN):

Plotting speed (SPEED)/ pen pressure (PRESS)

1 Press the **SEL** key in LOCAL to display the "TOOL" menu.

2 Press the **FUNC1** (TOOL).

3 Press **▲▼** to select a tool condition to be used, and press the **ENTER** key.

4 Press **▼** to move the cursor to cutting speed, and press the **ENTER** key.

5 Press **▲▼** to set the cutting speed, and press the **ENTER** key.

- Set the moving speed of the tool for cutting or pen plotting.
- **Setting values** : 1 to 10cm/s (settable by 1cm/s step)
15 to 30cm/s (settable by 5cm/s step)

6 Press **▼** to move the cursor to cutting pressure, and press the **ENTER** key.

7 Press **▲▼** to set the cutting pressure, and press the **ENTER** key.

- Set the pressure that the tool presses the sheet for cutting or pen plotting.
- **Setting values** : 10 to 20g (settable by 2g step)
25 to 100g (settable by 5g step)
110 to 450g (settable by 10g step)



- When the cutting (plotting) pressure setting is completed, proceed to the setting of the OFFSET value. When you set the plotting condition (PEN), you cannot set the OFFSET value and half cut. Proceed to the Step 16.
- The maximum pressure at selecting PEN is 150g.

8 Press **▼** to move the cursor to OFFSET, and press the **ENTER** key.

9 Press **▲▼** to set the offset value, and press the **ENTER** key.

- When you set the cutting condition (CUT1 to 7), set the distance between the center of the cutter holder and the blade tip.
- **Setting values** : 0 to 250 (0.00 to 2.50mm) (settable by 0.05mm step)

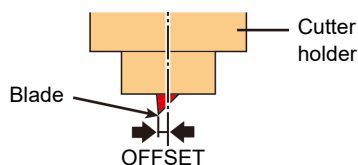

- Nothing is displayed on the LCD if "0" is specified.

10 Press **▼** to move the cursor to half cut, and press the **ENTER** key.

11 Press **▲▼** to set ON/OFF, and press the **ENTER** key.

- When you perform half cut, select ON and proceed to the Step 11.
- When you do not want to set AUTO CUT, select "OFF" and proceed to Step 17.

12 Press **▼** to move the cursor to pressure setting of left part (not to be cut), and press the **ENTER** key.

13 Press **▲▼** to set pressure, and press the **ENTER** key.

- Set the pressure of the left part (not to be cut) when performing half cut.
- **Setting values** : 0 to 450g (settable by 5g step)

14 Press **▼** to move the cursor to the setting of length to be left, and press the **ENTER** key.

15 Press **▲▼** to move the cursor to the setting of length to be left, and press the **ENTER** key.

- Set the length to be left not to be cut when performing half cut.
- **Setting values** : 0.1 to 5mm (settable by 0.1mm step)

16 Press **▼** to move the cursor to the setting of cut length, and press the **ENTER** key.

17 Press **▲▼** to set the cut length, and press the **ENTER** key.

- Set the length to be cut when performing half cut.
- **Setting values** : 5 to 150 mm (5 to 20mm: 1mm step, 20 to 150mm: 5mm step)

18 Press **END/POWER** the key to register the set contents.

- Return to the local.



- The set value is retained even when the power is turned "OFF".

Test Cutting

Execute test cutting to confirm the tool conditions.
In the test cutting, the machine cuts two squares.

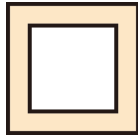

Important!

- When the cutter blade is worn and dull, you can use it temporarily by enhancing the value of PRESSURE. However, you are recommended to replace the worn cutter blade with a new one to ensure a satisfactory cutting quality.



When the tool conditions are proper, the results of test cutting are as follows:

- The two squares are cut perfectly.
- The base media remains uncut.
- No corner of the squares is rounded.
- No corner of the squares is curled-up.

1 Press the **[SEL]** key in LOCAL to display the "TEST CUT" menu.

2 Press the **[FUNC2]** (TEST CUT).

3 Press the **[ENTER]** key .

- The machine will execute test cutting and return to the local mode display.

Change the settings of the cut conditions according to the test cutting results.

Cut Condition	Cause	Solution
Some parts uncut.	The blade is lifted above the media because of a too high cutting speed.	Lower the speed. (☞ P.2-28).
		Tighten up the knob for the tool holder. (☞ P.2-25).
The base media has been cut.	Too high pressure.	Lower the pressure. (☞ P.2-28).
	Too large protrusion of the cutter blade.	Adjust the protrusion of the cutter blade. (☞ P.2-24).
Any of the square corners rounded.	Improper OFFSET value.	Adjust the OFFSET value so that it suits the cutter blade in use. (☞ P.2-28).
Any of the square corners curled-up.	The protruded cutter blade is too much. The cutting pressure is higher.	Adjust the protrusion of the cutter blade. (☞ P.2-24).
		Adjust the cutting pressure. (☞ P.2-28).
	The [COMPENSATION PRESSURE OFFSET value] is large. More than two out of the above fall under this category.	Adjust the ADJ-PRS OFS value. (☞ P.4-8).

Cutting Data

You can start cutting after completion of setting up a tool, a media and the tool conditions.

Setting the origin

The origin is a reference point for the cutting data. When the origin is changed, set the new origin before starting cutting.

Important!

- Change the origin before cutting the next data; otherwise, cutting will be performed over the previous data.

1 Move the carriage to a point at which the new origin is to be set.

- [▶]: Moves the carriage to the right.
- [◀]: Moves the carriage to the left.
- [▲]: Feeds the media to the rear of the machine.
- [▼]: Feeds the media to the front of the machine.

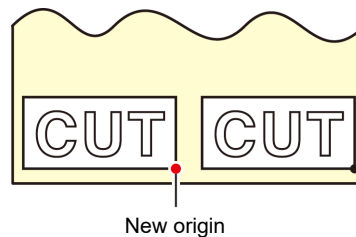

2 Press the **[ENTER]** key to register the origin.

- The display panel will show the effective cutting area first and the tool conditions.

Start cutting

1 After completion of setting the origin, press the **[FUNC3]** (REMOTE).

- The screen changes to REMOTE, and data can be received from the PC.

2 Transmit data to be cuted from the PC.

- On receiving the data, the machine performs cutting while displaying the remaining amount of the data.

Bringing the cutting to a halt

To temporarily stop the machine during cutting, press the [FUNC3] (REMOTE) key once. Another press of the key will make the machine resume cutting.

Important!

- In case the media has slipped off the machine during cutting operation, turn off the power immediately; otherwise, the main unit may be damaged.



- You cannot use the functions that include operations while pausing. In this case, let the machine complete the cutting for the remaining portion of the data or discontinue the cutting by executing data clearing (☞ P.2-30).

Stopping a Cutting Operation (Data Clear)

If you want to stop a cutting operation of the received data, clear the data.



- When clearing the data, the process will not restart even if you press the [FUNC3] (REMOTE) key.
- After clearing the data, switching to the remote mode and receiving another data, new data will be cut.

Important!

- Do not perform the data clearance during the data transmitting.
- Even after performing the data clearance, the received data is stored in the reception buffer.

1 Press the **[SEL]** key, and press the **[FUNC3] (DATA CLEAR)** in LOCAL.

2 Press the **[ENTER]** key.

- The reception buffer is cleared, and the present mode returns to LOCAL..

Removing the Cutter Unit Temporarily

When cutting or printing-with-a-pen job is finished, the cutter unit is on the platen.

To check the result of cutting (printing-with-a-pen) or to set a new medium, follow the steps below to remove the cutter unit from the platen temporarily.

1 Press the **[SEL]** key to display the “TEST CUT” menu.

2 Press the **[FUNC2] (TEST CUT)**.

3 Press **[▲] [▼]** to select the “CUTTER HEAD MOVE/RETRACT”, and press the **[ENTER]** key.

- The cutter unit moves from on the platen to the left end of the machine.
- When the coupling unit is connected to the printer unit, switch the destination to the cutter unit, and move to move it to the origin position. (Moving the cutter unit)

Cutting a media

By using the keys on the operation panel, you can cut the media at any position.

1 In Local, Press **[▲] [▼] [◀] [▶]**.

- It enters into the origin setting mode.
- By pressing **[▼]**, feed the media to the cutting position.

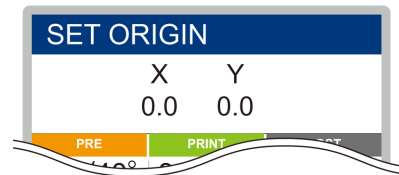

2 Press the **[FUNC2] [ENTER]** key.

- The media is cut.
- When the cutting has been completed, the current mode returns to LOCAL.

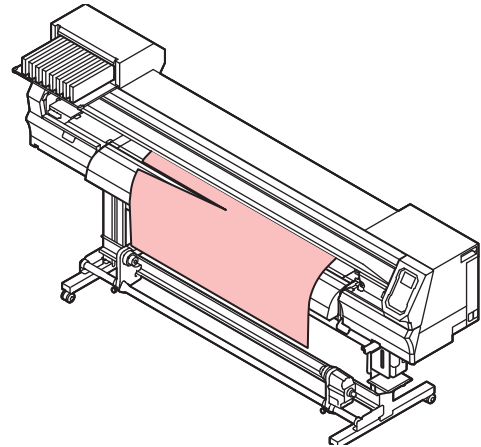



Chapter 3

Setup



This chapter

describes various settings of this machine.

About SETUP MENU	3-2	When using 600 ml cartridge	3-14
SETUP MENU table	3-3	Setting a LANGUAGE	3-16
Register the optimal print conditions to match the use	3-4	Setting Time	3-16
Setting of Media Correction	3-5	Setting Unit (Temperature/ Length)	3-17
If the Positions of Dots Shift	3-6	Setting a KEY BUZZER	3-17
Setting the HEATER	3-6	Setting the CONFIRM. FEED	3-17
Setting of Logical Seek	3-7	Setting the SPACE FEED MODE	3-17
Setting of Drying Time	3-7	Set the network	3-18
Setting of Left and Right Margins	3-8	Setting event mail function	3-18
Setting of VacuumFan	3-8	Initializing the Settings	3-22
Setting of Feed Speed	3-8	About NOZZLE CHECK MENU	3-23
Setting of MAPS	3-8	INFORMATION MENU table	3-23
Setting Auto Cleaning	3-9	Printing Check Flow	3-24
Setting Interval wiping	3-9	Printing Operations at “Nozzle Missing” Judgment and Error Occurrence	3-24
About MACHINE SETUP MENU	3-10	Setting the Printing Check	3-25
MACHINE SETUP MENU table	3-11	Setting the NOZZLE RECOVERY	3-25
Setting a AUTO Power-off	3-12	Setting the Judgement Condition	3-25
Setting Take-up unit	3-12	About INFORMATION MENU	3-26
Setting the Display of Media Residual	3-13	INFORMATION MENU table	3-27
Setting the Display of Media Detection	3-13	Displaying the Information	3-27

About SETUP MENU

On SETUP MENU, you can set the print conditions to match the media you usually use.

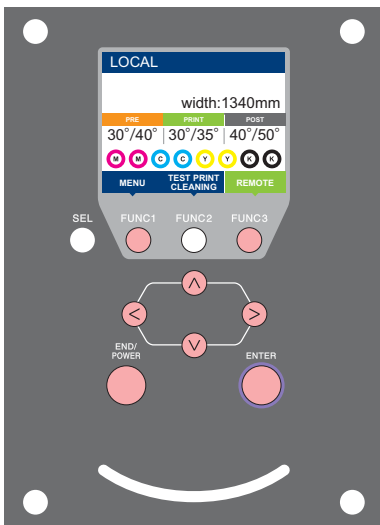

- FUNC1** : Press this to select SETUP MENU, or to switch to the previous screen.
- FUNC3** : Press this to switch to the next screen.
- ▲ ▼** : Use these to select a setting item.
- ENTER** : Press this to confirm a setting, etc..

◆ SETUP MENUS at-a-glance

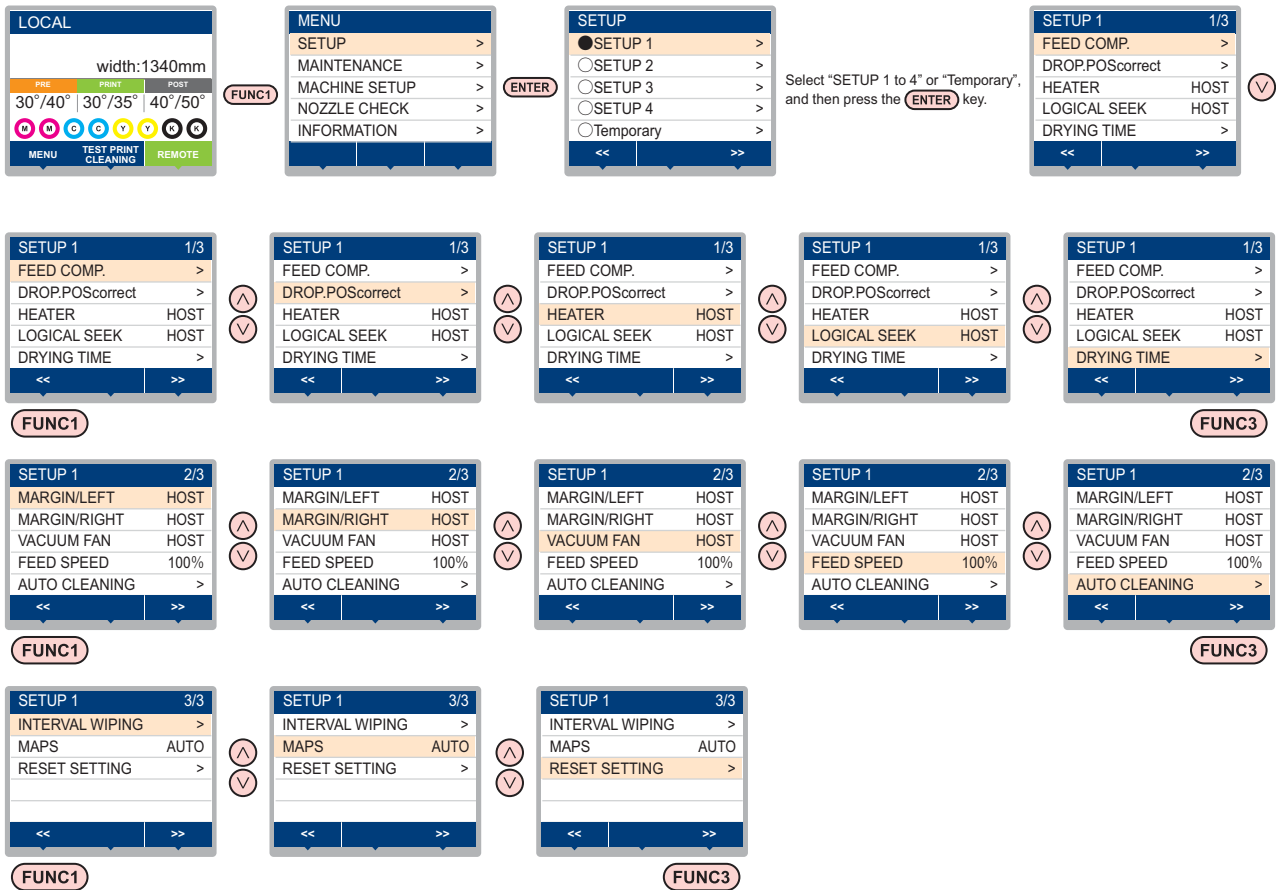

SETUP MENU table



- For each setting item below, you can set it so that the machine may operate according to the value specified when you printed from your RIP software in the connected host PC.
- **Set Item** : DRYING TIME/ MARGIN (LEFT and RIGHT)/ VACUUM FAN/ FEED SPEED
- When you operate the machine according to the contents specified with the RIP software, set each item to "Host" when registering this machine type. When you set it other than "Host", the machine operates according to the machine setting.
- For the specifying method with the RIP software, refer to the operation manual of the RIP software.

Function name		Set value	When no instruction from RIP exists ^{*1}	Outline	
FEED COMP. (P.3-5)		-9999 to 0 to 9999	_____	Used to print a pattern for correcting a media-feeding rate and correct it.	
DROP.POScorrect (P.3-6)		-40.0 to 0 to 40.0	_____	Used to adjust the dot position in go and return printing.	
HEATER (P.3-6)	PRE	OFF/ 20 to 50 °C (OFF/ 68 to 122°F)	_____	Sets each heater's conditions.	
	PRINT				
	POST				
	OFF TIME	NONE/ 0 to 90 min			Set the time from the print completion until the heater to be OFF.
LOGICAL SEEK (P.3-7)		HOST/ON / OFF	OFF	Sets the scan movable area during printing.	
DRYING TIME (P.3-7)	SCAN	HOST/0.0 to 9.9 sec	0 sec	Sets the time to wait for ink drying.	
	PRINT END	HOST/0 to 120 min	0 min	Sets the ink drying time after printing.	
MARGIN/LEFT (P.3-8)		-10 to 85mm	0 mm	Sets a non-printing area along the right and left edges of the media.	
MARGIN/RIGHT (P.3-8)			0 mm		
VACUUM FAN (P.3-8)		HOST/ WEAK/ STANDARD/ STRONG	STRONG	Sets the absorbability of the media.	
FEED SPEED ^{*2} (P.3-8)		10 to 100 to 200 %	100 %	Changes the media feeding speed in printing.	
AUTO CLEANING (P.3-9)	OFF, FILE, LENGTH, TIME		_____	Sets the automatic cleaning operation for the head performed before printing or during printing.	
	FILE	INTERVAL	1 to 1000		_____
		TYPE	NORMAL/ SOFT/ HARD		_____
	LENGTH	INTERVAL	0.1 to 100.0m		_____
		TYPE	NORMAL/ SOFT/ HARD		_____
	TIME	INTERVAL	10 to 120 min		_____
TYPE		NORMAL/ SOFT/ HARD	_____		
INTERVAL WIPING (P.3-9)		3 to 255 min, OFF	_____	Sets the wiping operation performed after printing is completed.	
MAPS (P.3-8)	AUTO			Change the effect of "MAPS".	
	MANUAL	Speed	50 ~ 100%		
		Smoothing level	0 ~ 100%		
RESET SETTING (P.3-5)		The configuration in the settings 1-4 can be reset individually.			

*1. This is the setting value to be used for printing when setting value is not specified at the RIP software (host) side, or, you give priority to the setting value at the machine side.

*2. When you set this to "100%" or more, required time for completion of printing will be shortened. However, enough drying time cannot be ensured and it may affect the image quality.

Register the optimal print conditions to match the use

In this machine, you will be able to register print conditions, SETUP 1 to 4 individually to match the media in advance.

For example, after print on different types of media, return to the media always use. In such case you can set the optimum printing conditions by simply selecting the registered SETUP 1 to 4.



- Print conditions that can be pre-registered with the machine are the four types, "SETUP 1" to "SETUP 4".
- If you print with the print condition which do not often use, you will be able to set the print conditions by selecting "Temporary". If turn on the power again, settings in "Temporary" will return to the original state when it was purchased. Also if turn on the power again in "Temporary" state, it will be the state in selecting "SETUP 1".

Register the print conditions to SETUP 1 to 4

- 1 Press the **FUNC1** (MENU) → **ENTER** key in LOCAL.
- 2 Press **▲** **▼** to select SETUP 1 to 4, and press the **ENTER** key.
 - The item selected indicates ● and others show ○.
 - SETUP MENU will be displayed.
- 3 Press **▲** **▼** to select and set each item in the setup menu list.
 - Please see the reference page in the setup menu list for detailed configuration procedure.

How to use [Temporary]

[Temporary] is not only to set the print condition to be used only once, but also can be used for partial change of the registered SETUP "1 to 4", or for reflecting the print conditions set by the [Temporary] to SETUP 1 to 4.

● Register the print conditions in [Temporary]

Registration of the print conditions to [Temporary] can be done as the same method as to SETUP 1 to 4.

- 1 Press the **FUNC1** (MENU) → **ENTER** key in LOCAL.
- 2 Press **▲** **▼** to select "Temporary", and press the **ENTER** key.
 - SETUP MENU will be displayed.
- 3 Press **▲** **▼** to select and set each item in the setup menu list.
 - Please see the reference page in the setup menu list for detailed configuration procedure.

● Copy the contents of SETUP 1 to 4 to [Temporary]

You can use it with changing the part of registration contents of SETUP 1 to 4.

Select "RESET SETTING" then "COPY" from the registration screen of [Temporary], and specify the copy source (SETUP 1 to 4).

- 1 Press the **FUNC1** (MENU) → **ENTER** key in LOCAL.
- 2 Press **▲** **▼** to select "Temporary", and press the **ENTER** key.
 - SETUP MENU will be displayed.
- 3 Press the **FUNC1** (<<).
- 4 Press **▲** **▼** to select "RESET SETTING", and press the **ENTER** key.
- 5 Press **▲** **▼** to select "COPY", and press the **ENTER** key.
 - Selection screen of the copy source will be displayed.
- 6 Press **▲** **▼** to SELECT the copy source (SETUP 1 to 4) and press the **ENTER** key.
 - Confirmation screen of the copy will be displayed.
- 7 Press the **ENTER** key.
 - Settings selected in step 5 is copied to Temporary.
- 8 Press **▲** **▼** to select the setting item to be changed, and press the **ENTER** key.
 - Please see the reference page in the setup menu list for detailed configuration procedure.

● Reflect The Content Set In [Temporary] To Setup 1 To 4

- 1 Press the **FUNC1** (MENU) → **ENTER** key in LOCAL.
- 2 Press **▲** **▼** to select "Temporary", and press the **ENTER** key.
 - SETUP MENU will be displayed.
- 3 Press **▲** **▼** to select and set each item in the setup menu list.
 - Please see the reference page in the setup menu list for detailed configuration procedure.
- 4 Display the last page of Temporary and select "SAVE SETTING", and press the **ENTER** key.
 - Selection screen of the save location will be displayed.
- 5 Press **▲** **▼** to select the location selected (SETUP 1 to 4), and press the **ENTER** key.
 - Save confirmation screen will be displayed.

- 6** Press the **ENTER** key.
 - Settings of Temporary will be saved to the location selected in step 5.
- 7** Press the **END/POWER** key several times to end the setting.

Reset the registered contents

Reset the contents registered to SETUP 1 to 4.

- 1** Press the **FUNC1** (MENU) → **ENTER** key in LOCAL.
- 2** Press **▲▼** to select SETUP 1 to 4 to be reset and press the **ENTER** key.
 - SETUP MENU will be displayed.
- 3** Press the **FUNC1** (<<).
- 4** Press **▲▼** to select "RESET SETTING", and press the **ENTER** key.
 - Confirmation screen of reset settings will be displayed.
- 5** Press the **END/POWER** key several times to end the setting.

Setting of Media Correction

Correct the media feed amount to match the type of media you are using.

If the correction value is not appropriate, stripes may appear on the printed image, thus resulting in a poor printing.

- Important!**
- On completion of [MEDIA COMP.] during use of a roll media, the media returns to the printing origin. Then the roll media in the rear of this machine will slacken. Before printing, take up the slack in the roll media by hand; a loose roll media can result in an inferior image quality.
 - When printing with a take-up device, set the media first and perform media correction.

A pattern for media correction is printed and a media-feeding rate is corrected.



- Two bands are printed in the correction pattern.
- Make adjustment so that an even color density is obtained in the boundary between the two bands.

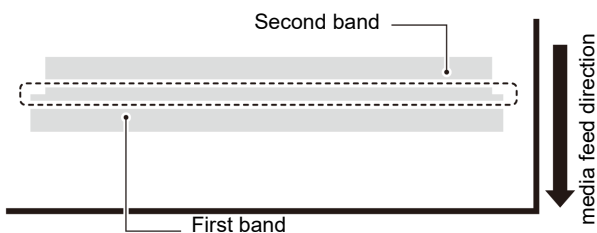

- 1** Set a media. (☞ P.2-4)
- 2** Press the **FUNC1** (MENU) → **ENTER** key in LOCAL.
- 3** Press **▲▼** to select SETUP 1 to 4, and press the **ENTER** key.
 - SETUP MENU will be displayed.
- 4** Press **▲▼** to select "FEED COMP", and press the **ENTER** key.
- 5** Press **ENTER** the key twice to print a correction pattern.
- 6** Check the correction pattern and enter a correction value.
 - A screen for entering the correction value will be displayed.
 - Enter a correction value in "+":
The boundary between the two bands is widened.
 - Enter a correction value in "-":
The boundary between the two bands is narrowed.
 - When you change the correction value by "30", the width of the boundary changes by about 0.1 mm.
- 7** Press the **ENTER** key.
 - Print a correction pattern again and check it.
 - When media correction is needed, perform the operation in Step 6 to make correction.
- 8** Press the **END/POWER** key several times to end the setting.

Correcting Media-feeding during Printing

A media-feeding rate can be corrected even in the remote mode or when image data is printed.

- 1** Press the **FUNC1** (ADJUST) → **ENTER** key in the Remote.
- 2** Press **▲▼** to enter a corrected feeding rate.
 - Corrected feeding rate: -9999 to 9999
 - The value entered here is reflected in the corrected feeding rate soon.
- 3** Press the **ENTER** twice key.
 - key. The changed value is registered.
 - When you press the [ENTER] key instead of the [END] key, the value entered here will be valid temporarily. (When you perform media detection again or turn the power OFF, the correction value is cleared.)

If the Positions of Dots Shift...

When the condition for printing (media thickness/ink type/ etc.) has been changed, perform the following operation to correct the ink drop position for bidirectional (Bi) printing and obtain the proper printing result.

Example of a Printed Pattern

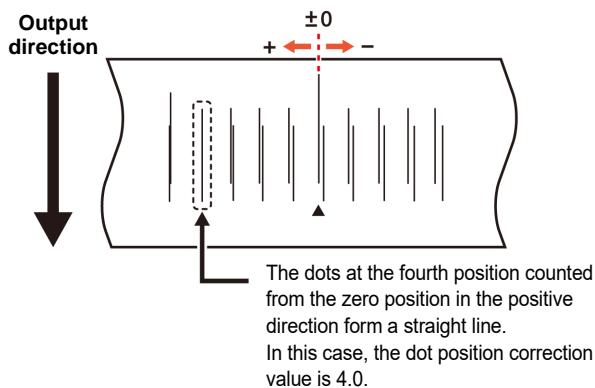

- 1** Set a media on the machine. (🔗 P.2-4)
 - In order to print a pattern, a media that is 500 mm wide at least is necessary.
- 2** Press the **[FUNC1] (MENU) → [ENTER]** key in LOCAL.
- 3** Press **[▲] [▼]** to select SETUP 1 to 4, and press the **[ENTER]** key.
 - SETUP MENU will be displayed.
- 4** Press **[▲] [▼]** to select “DROP.POScorrect”, and press the **[ENTER]** key.
- 5** Press the **[ENTER]** key.
 - Start the pattern printing.
 - Multiple test patterns are printed. (The printed patterns are called Pattern 1, Pattern 2, Pattern 3... in the order of printing.)
- 6** Press **[▲] [▼]** to enter a correction value of Pattern 1, and press the **[ENTER]** key.
 - Corrected feeding rate: -40 to 40
 - Check the test patterns. The position where an outward feeding line and a return feeding line become one straight line is the correction value.
 - When the correction value is not between -40 and 40, adjust the height of the printing heads and perform the operations in Step 2 and later.
- 7** In the same way as in Step 4, enter a correction value of Pattern 2 and later, and press the **[ENTER]** key.
- 8** Press the **[END/POWER]** key several times to end the setting.

Setting the HEATER

Pre-heater /Print heater / Post-heater are equipped on the platen.

Type of HEATER	Function
Pre-heater	Used for pre-heating of the media prior to printing to prevent rapid temperature changing.
Print-heater	Improves the image quality in printing.
Post-heater	Dries ink after printing.

Here, in addition to the temperature setting of each heater, the time from the print completion until the heater to be OFF can be set up.

- 1** Press the **[FUNC1] (MENU) → [ENTER]** key in LOCAL.
- 2** Press **[▲] [▼]** to select SETUP 1 to 4, and press the **[ENTER]** key.
 - SETUP MENU will be displayed.
- 3** Press **[▲] [▼]** to select “HEATER”, and press the **[ENTER]** key.
- 4** Set each heater temperature by pressing **[▲] [▼] [◀] [▶]**.
 - Heater selecting : by the **[▲] [▼]** keys
 - Temperature setting : by the **[◀] [▶]** keys
- 5** Press **[▲] [▼]** to select “OFFTIME”, and press the **[ENTER]** key.
- 6** Press **[▲] [▼]**, set the time until the heater to be OFF after printing, and press the **[ENTER]** key.
- 7** Press the **[END/POWER]** key several times to end the setting.



- press **[FUNC3]** (off) in Step 3 to turn all heaters OFF.
- or, press **[FUNC1]** to raise all heaters by 10°C.
- If press keys or receive data during OFF is set in step 6, automatically returns to the set temperature.

Setting of Logical Seek

The head's operation varies depending on the LOGICAL SEEK settings, as shown in the figure below.

Movement of heads when LOGICAL seek is OFF

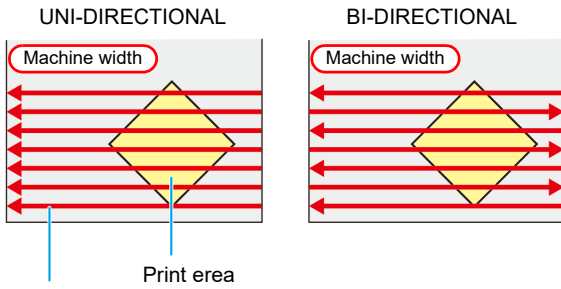

Red arrow :
Movement of head

Movement of heads when LOGICAL seek is ON

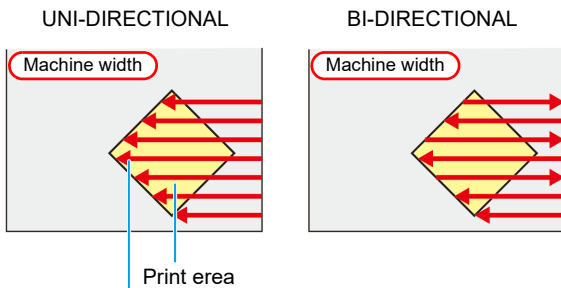

Red arrow :
Movement of head

- 1 Press the **FUNC1** (MENU) → **ENTER** key in LOCAL.
- 2 Press **▲** **▼** to select SETUP 1 to 4, and press the **ENTER** key.
 - SETUP MENU will be displayed.
- 3 Press **▲** **▼** to select "LOGICAL SEEK", and press the **ENTER** key.
- 4 Press **▲** **▼** to select a set value, and press the **ENTER** key.
 - Set value : HOST / ON / OFF
- 5 Press the **END/POWER** key several times to end the setting.

Setting of Drying Time

In the drying time setting, the following items for ink drying time are set.

- **SCAN** : Ink drying time for each scanning is set. (During bidirectional printing, the machine stops for a certain period of time specified for each of the outward and return scanning.)
- **PRINT END** : Ink drying time for after printing is set.

Important!

- When you give priority to the setting at the RasterLink side, make the setting value "Host".
- "SCAN" set in this machine is displayed as "Pause Time per Scan" in the RasterLink.
- You cannot specify the print end at the RasterLink side. When you set this machine to "Host", printing will be performed in "PRINT END= 0 sec." status.

- 1 Press the **FUNC1** (MENU) → **ENTER** key in LOCAL.
- 2 Press **▲** **▼** to select SETUP 1 to 4, and press the **ENTER** key.
 - SETUP MENU will be displayed.
- 3 Press **▲** **▼** to select "DRYING TIME", and press the **ENTER** key.
- 4 Press the **ENTER** key.
- 5 Press **▲** **▼** **◀** **▶** to set drying time, and press the **ENTER** key.
 - Set the drying time for canning and after printing is completed. To enable the drying time specified in your RIP, select "Host".
 - **Scanning setting value** :
Host or 0.0 sec. to 9.9 sec.
 - **Print end setting value** :
Host or 0 sec. to 120 min.
 - **Item selecting**: by the [**▲**][**▼**] keys
 - **Time setting**: by the [**◀**][**▶**] keys
- 6 Press the **END/POWER** key several times to end the setting.

Setting of Left and Right Margins

Set a non-printing area along the left and right edges of the media.

The offset value against the standard margin 15mm is set hereupon.



- When you give priority to the setting at the RIP software side, make the setting value "Host".
- You cannot specify the margins at the attached RIP software (RasterLink). When you use the RasterLink, if you set this machine to "Host", printing will be performed in "Margins for right and left off set value= 0 mm" status.
- The margin setting is reflected when the media width is detected.

- 1 Press the **FUNC1** (MENU) → **ENTER** key in LOCAL.
- 2 Press **▲** **▼** to select SETUP 1 to 4, and press the **ENTER** key.
 - SETUP MENU will be displayed.
- 3 Press the **FUNC3** (>>).
- 4 Press **▲** **▼** to select "Margin/L" or "Margin/R", and press the **ENTER** key.
- 5 Press **▲** **▼** to select a set value, and press the **ENTER** key.
 - Set value : HOST / -10 to 85 mm
- 6 Press the **END/POWER** key several times to end the setting.



- Pay attention to that printing may start on the media press if a right and left margin is set to 5 mm or less when the media press is used in printing.

Setting of VacuumFan

Sets the absorbability of the media.

By setting the absorption power to match the media, you can prevent print errors due to media rise-up.

- 1 Press the **FUNC1** (MENU) → **ENTER** key in LOCAL.
- 2 Press **▲** **▼** to select SETUP 1 to 4, and press the **ENTER** key.
 - SETUP MENU will be displayed.
- 3 Press the **FUNC3** (>>).
- 4 Press **▲** **▼** to select "VACUUM FAN", and press the **ENTER** key.

- 5 Press the **ENTER** key.

- 6 Press **▲** **▼** to select a set value, and press the **ENTER** key.

- Set value : HOST/WEAK /STANDARD/ STRONG

- 7 Press the **END/POWER** key several times to end the setting.

Setting of Feed Speed

Changes the media feeding speed in printing.

- 1 Press the **FUNC1** (MENU) → **ENTER** key in LOCAL.
- 2 Press **▲** **▼** to select SETUP 1 to 4, and press the **ENTER** key.
 - SETUP MENU will be displayed.
- 3 Press the **FUNC3** (>>).
- 4 Press **▲** **▼** to select "FEED SPEED", and press the **ENTER** key.
- 5 Press the **ENTER** key.
- 6 Press **▲** **▼** to select a set value, and press the **ENTER** key.
 - Set value : HOST / 10 to 200%
- 7 Press the **END/POWER** key several times to end the setting.



- Some settings do not change the speed depending on the print conditions.

Setting of MAPS

The MAPS (Mimaki Advanced PassSystem) function to disperse the pass boundary to make the feeding stripes less visible.

With this function, the degree of application of MAPS can be changed.



- MAPS provides two setting options: "AUTO" and "MANUAL" MAPS applies the one most suitable for your printing conditions, so please normally use "AUTO" (default value).
- In order to use this function, Mimaki driver Ver 4.2.0 or higher is required.



- Changing the MAPS settings may change the color tone. Check the effects before use.
- MAPS may not be effective depending on image to be printed. Use it after checking effect in advance.

Setting Auto Cleaning

You can set the machine so that it counts the number of printed files or the length or time after printing has been completed, and performs cleaning automatically if required. You can select the auto cleaning setting from three types below:

- **PAGE** : Set the cleaning intervals by the number of printed files.
- **LENGTH** : Set the cleaning intervals by the printed length.
- **TIME** : Set the cleaning intervals by the printed time.

The machine can perform a stable printing operation with its heads always kept clean.

Besides, automatic nozzle check after auto cleaning can be set. (Cleaning Check function)

The machine can perform a stable printing operation with its heads always kept clean.

1 Press the **FUNC1** (MENU) → **ENTER** key in LOCAL.

2 Press **▲▼** to select **SETUP 1 to 4**, and press the **ENTER** key.

- SETUP MENU will be displayed.

3 Press the **FUNC3** (>>).

4 Press **▲▼** to select “**AUTO CLEANING**”, and press the **ENTER** key.

5 Press **ENTER** key, and press **▲▼** to select the type of auto cleaning.

- There are “PAGE”, “LENGTH” and “TIME” for auto cleaning.
- **FILE**:When the set number of prints has been completed, the machine performs head cleaning automatically.
- **LENGTH**:When the set length has passed, the machine performs head cleaning automatically.
- **TIME**:When the set time has passed, the machine performs head cleaning automatically.
- If you do not set auto cleaning, first select “OFF” and proceed to the Step 7.

6 Press **ENTER** key, and press **▲▼** to select the cleaning interval.

- Depending on the auto cleaning type selected in the Step 3, the setting value differs.
- For **FILE** : 1 to 1000 file
- For **LENGTH** : 0.1 to 100.0m (in 0.1m increment)
- For **TIME** : 10 to 120min (in 10min increment)

7 Press **ENTER** key, and press **▲▼** to select the cleaning type.

- Set Value : NORMAL/ SOFT/HARD

8 Press **ENTER** key, and press **▲▼** to select “Cleaning Check”.

9 Press **ENTER** key, and press **▲▼** to select set value.

- Set Value : ON/ OFF

10 Press the **ENTER** key.

11 Press the **END/POWER** key several times to end the setting.

Important!

- Depending on the state of the heads, etc., the image quality deterioration may not be improved even with this function performed. In this case, contact our service office or the distributor in your region.

Setting Interval wiping

When the set time has passed, nozzle face of the head is cleaned automatically to remove ink droplets on the nozzle face.

In case that deflection, nozzle missing, or symptom which ink droplets fall down occurred, set the interval between each operation shorter.

1 Press the **FUNC1** (MENU) → **ENTER** key in LOCAL.

2 Press **▲▼** to select **SETUP 1 to 4**, and press the **ENTER** key.

- SETUP MENU will be displayed.

3 Press the **FUNC1** (<<).

4 Press **▲▼** to select “**INTERVAL WIPING**”, and press the **ENTER** key.

5 Press **▲▼** to set intervals.

- Set Value : 3 to 255 Minutes, OFF
- When [OFF] is set, periodical wiping is not executed.

6 Press the **ENTER** key.

7 Press the **END/POWER** key several times to end the setting.

About MACHINE SETUP MENU

Common settings are functions for using this machine easily.
The following items can be set in Machine settings.

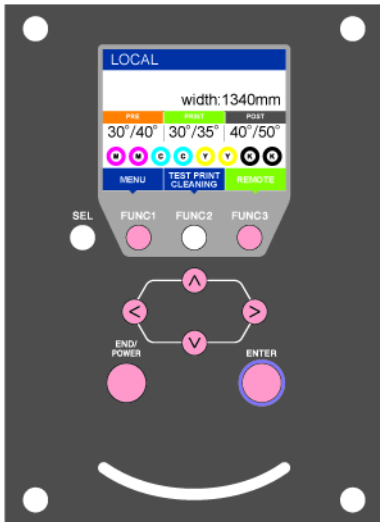

- FUNC1** : Press this to select MACHINE SETUP MENU, or to switch to the previous screen.
- FUNC3** : Press this to switch to the next screen.
- ▲ ▼** : Use these to select a setting item.
- ENTER** : Press this to confirm a setting, etc..

◆ MACHINE SETUP MENUS at-a-glance

The screenshots illustrate the following navigation steps:

- LOCAL** screen: Press **FUNC1** (Two times) to enter the **MENU** screen.
- MENU** screen: Press **ENTER** to select **MACHINE SETUP**.
- MACHINE SETUP** screen: Press **▲ ▼** to select **AUTO POWER OFF** (30min).
- MACHINE SETUP** screen: Press **▲ ▼** to select **TAKE-UP UNIT**.
- MACHINE SETUP** screen: Press **▲ ▼** to select **Drying/Exhaust FAN**.
- MACHINE SETUP** screen: Press **▲ ▼** to select **MEDIA REMAIN** (OFF).
- MACHINE SETUP** screen: Press **▲ ▼** to select **MEDIA DETECT**.
- MACHINE SETUP** screen: Press **FUNC1** to return to the main menu.
- MACHINE SETUP** screen: Press **▲ ▼** to select **600cc cartridge**.
- MACHINE SETUP** screen: Press **▲ ▼** to select **LANGAGE**.
- MACHINE SETUP** screen: Press **▲ ▼** to select **TIME**.
- MACHINE SETUP** screen: Press **▲ ▼** to select **UNIT/TEMP.** (°C).
- MACHINE SETUP** screen: Press **▲ ▼** to select **UNIT/LENGTH** (mm).
- MACHINE SETUP** screen: Press **FUNC3** to return to the main menu.
- MACHINE SETUP** screen: Press **FUNC1** to return to the main menu.
- MACHINE SETUP** screen: Press **▲ ▼** to select **KEY BUZZER**.
- MACHINE SETUP** screen: Press **▲ ▼** to select **CONFIRM. FEED**.
- MACHINE SETUP** screen: Press **▲ ▼** to select **SPACE FEED MODE**.
- MACHINE SETUP** screen: Press **▲ ▼** to select **NETWORK**.
- MACHINE SETUP** screen: Press **▲ ▼** to select **EVENT MAIL**.
- MACHINE SETUP** screen: Press **FUNC3** to return to the main menu.
- MACHINE SETUP** screen: Press **FUNC1** to return to the main menu.
- MACHINE SETUP** screen: Press **FUNC3** to return to the main menu.

MACHINE SETUP MENU table

Function name		Set value		Default	Meaning
AUTO Power-off (☞ P.3-12)		NONE/ 10 ~ 600min		30min	When no operation has been performed for the set time, the power supply is automatically turned "OFF".
TAKE-UP UNIT (☞ P.3-12)	TAKE-UP UNIT	ON/ OFF		ON	For setting whether the take-up unit is used or not used.
	TAKE-UP SW	Continuance/ Temporary		Continuance	Set the operation method when press the ON / OFF button on the take-up unit.
Drying/Exhaust FAN		Set this when you use the optional drying/exhaust fan. For details, refer to the user manual supplied with the drying/exhaust fan.			
MEDIA REMAIN (☞ P.3-13)		ON/ OFF		OFF	You can control the remaining amount of media.
MEDIA DETECT (☞ P.3-13)	DETECTION TYPE	AUTO/MANUAL		AUTO	Set the media detection method.
	USE PR NUMBER QUERY	ON / OFF		ON	Set whether or not to enter the number of the pinch rollers you are using during media detection.
600ml cartridge *1 (☞ P.3-14)	case weight				Setting the weight of eco-cases.
	cartridge weight				Setting the weight of cartridges.
LANGUAGE (☞ P.3-16)		English / 日本語		English	Displayed language is changed.
TIME (☞ P.3-16)		+4h ~ -20h		Japan time	Time difference is corrected.
UNIT/ TEMP. (☞ P.3-17)		°C (Centigrade)/°F (Fahrenheit)		°C	A unit for displaying temperature is set.
UNIT/ LENGTH (☞ P.3-17)		mm / inch		mm	A unit for displaying length and area is set.
KEY BUZZER (☞ P.3-17)		OFF / ON		ON	A buzzer sound when keys are pressed is set.
CONFIRM. FEED (☞ P.3-17)		ON / OFF		ON	Set whether media feeding is performed for checking the result of the test printing etc. or not.
SPACE FEED MODE (☞ P.3-17)		INTERMITTENT / CONTINUOUS		INTERMITTENT	Change the feed mode of the margin included in the image data.
NETWORK (☞ P.3-18)	Set the network.				
	Check IP Addr.	The IP address currently used by this machine is displayed.			
	Check MAC Addr.	The IP address currently used by this machine is displayed.			
	DHCP	ON / OFF			When it is ON, the IP address given by the DHCP server is used.
	AutoIP	ON / OFF			When it is ON, the IP address is determined by the AutoIP protocol. However, DHCP is ON, DHCP has priority.
	IP Address *2	Set the IP address used by this machine.			
	Default Gateway *1	Set the default gateway used by this machine.			
	DNS Address *1	Set the DNS server address used by this machine.			
	SubNet Mask *1	Set the digit number of the subnet mask used by this machine.			
EVENT MAIL	Mail Delivery (☞ P.3-19)	ON / OFF		OFF	Set whether you send/ do not send the e-mail when the set event occurs.
	Select Event (☞ P.3-19)	Print Start Event	ON / OFF	OFF	Set whether you send/ do not send the e-mail at the start of printing.
		Print End Event	ON / OFF	OFF	Set whether you send/ do not send the e-mail at the end of printing.
		Error Event	ON / OFF	OFF	Set whether you send/ do not send the e-mail when a error occurs.
		Warning Event	ON / OFF	OFF	Set whether you send/ do not send the e-mail when a warning occurs.
		Other Event	ON / OFF	OFF	Set whether you send/ do not send the e-mail when an event other than the above occurs.
	Mail Address (☞ P.3-19)	Set the e-mail address to which you send the event mail.		Alphanumeric characters and symbols (within 96 characters)	
Message Subject (☞ P.3-19)	Set the characters to write in the subject of the event mail.		Alphanumeric characters and symbols (within 8 characters)		

Function name		Set value	Default	Meaning	
EVENT MAIL	Server Setup (P.3-20)	SMTP Address		Set the SMTP server.	
		SMTP Port No.		Set the SMTP port number.	
		SENDER ADDRESS			Set the e-mail address to be used as the sender mail address.
		Authentication	POP before SMTP		Set the SMTP server authentication method (SMTP authentication).
			SMTP Authentication		
			OFF		
		User Name * ³			Set the user name used for the authentication.
		Pass Word * ²			Set the password used for the authentication.
	POP3 Address * ⁴			Set the POP server.	
APOP * ³			Set ON/ OFF of APOP.		
Transmit Test (P.3-21)	Send the test e-mail.				
RESET(P.3-22)			All setting values are returned to the status default.		

*1. It is not displayed when the 600ml cartridge is not set in the ink slot.

*2. Settable when both of DHCP and AutoIP are [OFF]

*3. Settable only when Auth. is not OFF

*4. Settable only when Auth. is POP before SMTP

Setting a AUTO Power-off

When no operation has been performed for the set time, the power supply is automatically turned "OFF".

- 1** Press the **(FUNC1) (MENU)** **(twice)** **(ENTER)** key in LOCAL.
• MACHINE SETUP MENU will be displayed.
- 2** Press **(▲) (▼)** to select "AUTO POWER OFF", and press the **(ENTER)** key.
- 3** Press **(▲) (▼)** to select a set value, and press the **(ENTER)** key.
• Set Value : none, 10 to 600min
- 4** Press the **(END/POWER)** key several times to end the setting.

Setting Take-up unit

Set the operation method when press the ON / OFF button on the take-up unit.

Also, when the optional tension bar is installed, for setting whether the tension bar is used or not used.

- 1** Press the **(FUNC1) (MENU)** **(twice)** **(ENTER)** key in LOCAL.
• MACHINE SETUP MENU will be displayed.
- 2** Press **(▲) (▼)** to select "TAKE-UP UNIT", and press the **(ENTER)** key.
- 3** Press **(▲) (▼)** to select "TAKE-UP UNIT", and press the **(ENTER)** key.

- 4** Press **(▲) (▼)** to select a set value, and press the **(ENTER)** key.
• Set Value : ON/ OFF
- 5** Press **(▲) (▼)** to select "TENSION BAR", and press the **(ENTER)** key.
- 6** Press **(▲) (▼)** to select a set value, and press the **(ENTER)** key.
• Set Value : ON/ OFF
- 7** Press **(▲) (▼)** to select "TAKE-UP SW", and press the **(ENTER)** key.
- 8** Press **(▲) (▼)** to select a set value, and press the **(ENTER)** key.
• Set Value : Continuance/ Temporary
Continuance :
Switching ON / OFF the winding operation when pressing the switch each time. (Take-up unit in operation does not stop until press again ON / OFF switch.)
Temporary :
Do the winding operation only while holding down the switch. (When release the switch, winding operation is stopped.)
- 9** Press the **(END/POWER)** key several times to end the setting.

Setting the Display of Media Residual

Whether the screen displays the remaining amount of a media is set.

When the media remaining amount display is turned to "ON"	the remaining amount of a media is displayed in Remote. (However, when a leaf media is used, the length of the media to be printed is displayed.)
When the media remaining amount display is turned to "OFF"	the remaining amount of a media is not displayed in the Remote.



- The amount of a media that has been fed by the printing and jog keys is reflected in the remaining amount of a media.
- The length of a media (initial value of the remaining amount) is entered when a roll media is detected. (P.2-13)
- The setting configured here does not become effective unless media detection is performed after the setting has been complete.

- 1 Press the **FUNC1 (MENU)** (twice) **ENTER** key in LOCAL.
• MACHINE SETUP MENU will be displayed.
- 2 Press **▲▼** to select "MEDIA REMAIN", and press the **ENTER** key.
- 3 Press **▲▼** to select ON/OFF.
- 4 Press the **ENTER** key.
- 5 Press the **END/POWER** key several times to end the setting.

Setting the Display of Media Detection

Set the following two items in media detection settings.

Setting of Media Detection	When loading the media, set whether to detect the media width automatically (AUTO) or decide the print (or cut) range manually (MANUAL).
USE PR NUMBER QUERY	Set whether or not to enter the number of the pinch rollers you are using during media detection.



- When using the media that cannot be detected by the sensor, such as black cutting sheets, set the media detection setting to "MANUAL".

- 1 Press the **FUNC1 (MENU)** (twice) **ENTER** key in LOCAL.
• MACHINE SETUP MENU will be displayed.
- 2 Press **▲▼** to select "MEDIA DETECT", and press the **ENTER** key.
- 3 Press **▲▼** to select "MEDIA DETECT", and press the **ENTER** key.
- 4 Press **▲▼** to select AUTO/MANUAL.
- 5 Press the **ENTER** key.
- 6 Press **▲▼** to select "USE PR NUMBER QUERY", and press the **ENTER** key.
- 7 Press **▲▼** to select ON/OFF.
- 8 Press the **ENTER** key.
- 9 Press the **END/POWER** key several times to end the setting.



- If you set the input of the number of pinch rollers "OFF" in step 8, the pinch roller pressure and the number of use, that has been set in RasterLink6, may not match in some cases. Set to "OFF" only when performing set of pinch roller pressure (P.2-13) in this machine.

When using 600 ml cartridge

Requisite for the 600 ml cartridge

Eco Case	The 600 ml ink pack and the attached ink IC chip are put in the eco case and used. This is referred to as "600 ml cartridge" in this manual.
600 ml Ink Pack	
Ink IC Chip *1	
Scale	To calculate the remaining ink quantity, input the weight of the eco case and the 600 ml cartridge into this machine. Use a scale for weight measuring. (To manage the accurate remaining ink quantity, prepare the scale that can weigh in one gram unit.)

*1. Attached to the 600ml ink pack.

Mounting/removing 600 ml ink pack

Be sure to put the ink pack and the ink IC chip in the eco case for setting the 600 ml cartridge on the ink station.

Precaution for using 600 ml cartridge

Be sure to put the ink pack and the ink IC chip in the eco case for setting the 600 ml cartridge on the ink station.



- This machine cannot judge whether the 600 ml ink pack is in the eco case or not. When using the 600 ml cartridge, be sure to attach the ink pack.
- Setting an eco case without ink IC chip on the machine will break this machine. Be sure to attach the ink IC chip to the eco case before use.

Registering weight of eco case

Register the eco case weight on this machine to calculate the remaining ink quantity from the weight of the 600 ml cartridge.



Register the weight of the eco case in the following cases.









- For using the 600 ml cartridge for the first time
- When the case weight is changed by replacing the eco case.



- The weight of each eco case slightly differs respectively. To control accurate ink quantity, be sure to register the weight of each eco case.













When using 600 ml cartridge for the first time

When the 600 ml cartridge is set in the slot of the ink station, the weight registration function of the eco case automatically starts.

- 1 Measure the weight of the eco case.**
 - Measure the weight of the eco case only in advance.
 - If the 600 ml ink pack is in the eco case, remove the 600 ml ink pack and perform measurement.
- 2 Set the 600 ml cartridge in the ink station.**
 - Mount the 600 ml ink pack and the ink IC chip on the eco case, and set it to the ink slot.
 - The input screen for the weight of the eco case will be displayed.
- 3 Press     to input the weight of the eco case.**
 - Press the [][] keys to move to another digit.
 - Press the [][] keys to input the weight.
- 4 Press the  key.**
 - For setting 600 ml cartridges in multiple slots, repeat the procedures in Step 2 and 3.
 - After all registration is completed, the device will return to the status before the weight registration function was initiated.

When the eco case weight is changed

When the case weight is changed by replacing the eco case, register the weight of the eco case in the following procedures.

- 1 Press the  (MENU)  (twice)  key in LOCAL.**
 - MACHINE SETUP MENU will be displayed.
- 2 Press the .**
- 3 Press   to select "600ml Cartridge", and press the  key.**
 - When the 600 ml cartridge is not set, "600 ml Cartridge" will not be displayed.
 - It is recommended to measure the weight of the eco case in advance and perform the procedure from the Step 3.
- 4 Press the  key.**
- 5 Press   and  key, to select the [Slot].**
 - The selected slot is highlighted.
- 6 Press the  key.**

- 7** Press **▲▼◀▶** to input the weight of the eco case.
- Press the [**◀**][**▶**] keys to move to another digit.
 - Press the [**▲**][**▼**] keys to input the weight.

- 8** Press the **ENTER** key.
- The slot selection screen is displayed again.
 - When you want to register the weight of another slot continuously, repeat the Step 4 to select a slot.

- 9** Press the **END/POWER** key several times to end the setting.

Registering the total weight of the ink cartridge

When you have to correct the amount of remaining ink, follow the steps below to register the total weight of the ink cartridge.

- 1** Press the **FUNC1 (MENU) ▶▼** (twice) **▶ENTER** key in LOCAL.
- MACHINE SETUP MENU will be displayed.
- 2** Press the **FUNC3 (>>)**.
- 3** Press **▲▼** to select “600ml Cartridge”, and press the **ENTER** key.
- When the 600 ml cartridge is not set, “600 ml Cartridge” will not be displayed.
 - It is recommended to measure the weight of the eco case in advance and perform the procedure from the Step 3.
- 4** Press **▼**, and press the **ENTER** key.
- 5** Press **▲▼** and **FUNC3 (page >)** key, to select the [Slot].
- The selected slot is highlighted.
- 6** Press the **ENTER** key.
- 7** Press **▲▼◀▶** to input the weight of the cartridge.
- Press the [**◀**][**▶**] keys to move to another digit.
 - Press the [**▲**][**▼**] keys to input the weight.
- 8** Press the **ENTER** key.
- The slot selection screen is displayed again.
 - When you want to register the weight of another slot continuously, repeat the Step 4 to select a slot.
- 9** Press the **END/POWER** key several times to end the setting.

When [Ink Level low] is displayed

When quantity of the remaining 600 ml ink becomes low, a warning [Ink Level] appears. Enter the weight of the cartridge with the Ink Level Set function.

- Important!**
- This machine recalculates usable amount of remaining ink by entering the weight of the 600 ml cartridge.
 - Ink Level Set function starts by resetting the 600 ml cartridge indicating [Ink Level] warning in the local mode or remote mode (during waiting or printing).
 - Weight the cartridge exactly down to the gram. Entering a larger weight than the actual one may cause Nozzle Drop Out.

Using Ink Level Set function

- 1** If [Ink level low] is displayed, remove the 600ml cartridge and measure the weight of the 600ml cartridge.

- Be sure to measure the weight of the eco case including the 600 ml ink pack.



Displays the cartridge causing [Ink Level] warning.

Upper line : Ink color being set

Lower line : Cartridge condition

“-” No error

“L” Ink Level Low (low)

“E” Ink Level End (end)



- Use the “E” display as a guide for replacing the ink pack.
- If ink remains much in the ink pack even when “E” is displayed, proceed to the Step 2 and the subsequent steps.

- Important!**
- Ink in the ink pack cannot be completely used up. To prevent ink supply errors, about 30 ml of ink must remain in the ink pack.

- 2** Reset the 600 ml cartridge.

- 3** Press **◀**.

- 4** Press **▲▼◀▶** to input the weight of the 600ml cartridge.



Displays the set number of times of weight to the cartridge being operated.

- Press the [**◀**][**▶**] keys to move to another digit.
- Press the [**▲**][**▼**] keys to input the weight.

5 Press the **[ENTER]** key twice.

- Usable amount of remaining ink is recalculated.
- The contents displayed differ depending on the amount of remaining ink.

(1) When ink still remains

- Return to the local mode or the remote mode.
- [Ink Level] warning disappears and the state of the 600 ml cartridge that Ink Level Set function was performed changes to [INK NEAR END] warning.
- [INK NEAR END] warning can be checked on the guidance function. (☞ P.3-27)

(2) When no ink remains

- A message for replacing the ink pack is displayed.
- Press the [ENTER] key to return to the local mode or the remote mode.
- [Ink Level] warning is still displayed and the state of the 600 ml cartridge that Ink Level Set function was performed changes to [INK END] warning.
- [INK END] warning can be checked on the guidance function. (☞ P.3-27)

Important!

- Once a message for replacing the ink pack appears, immediately replace the target ink pack with a new one. (Usable ink has been used up.)
- Ink in the ink pack cannot be completely used up. To prevent ink supply errors, about 30 ml of ink must remain in the ink pack. (Before shipping, more than 630 ml of ink is filled in the ink pack to use 600 ml.)

● When an error occur in the Step 5

This function stores the calculated quantity of remaining ink in the ink IC chip of the 600ml cartridge.

If the 600ml cartridge is removed or there is a problem on the contact of this machine and the ink IC chip, the data storage in the ink IC chip cannot be performed. In this case, the error message "ERROR 614 Preservation Fail" will be displayed.

If the message is displayed, reinsert the 600ml cartridge and follow the procedures from the Step 2 again.

Error when performing maintenance function

When performing the maintenance function such as the head cleaning or the ink filling for the 600 ml cartridge, selected functions can be performed if the quantity of remaining ink is enough to execute the function, even if the ink near end occurs.

If the quantity of remaining ink is not enough, a error message "ERROR 614 Preservation Fail" appears, and selected maintenance function is not performed.

Setting a LANGUAGE

You can change the displayed language.

1 Press the **[FUNC1] (MENU) → [▼]** (twice) → **[ENTER]** key in LOCAL.

- MACHINE SETUP MENU will be displayed.

2 Press the **[FUNC3] (>>)**.

3 Press **[▲] [▼]** to select "LANGUAGE", and press the **[ENTER]** key.

4 Press **[▲] [▼]** to select language, and press the **[ENTER]** key.

5 Press the **[END/POWER]** key several times to end the setting.

Setting Time

You can set time of your country (time difference).

1 Press the **[FUNC1] (MENU) → [▼]** (twice) → **[ENTER]** key in LOCAL.

- MACHINE SETUP MENU will be displayed.

2 Press the **[FUNC3] (>>)**.

3 Press **[▲] [▼]** to select "TIME", and press the **[ENTER]** key.

4 Press **[▲] [▼] [◀] [▶]** to enter time, and press the **[ENTER]** key.

- Year/Month/Day/Time selecting: by the [◀][▶] keys.
- Year/Month/Day/Time inputting: by the [▲][▼] keys.

5 Press the **[END/POWER]** key several times to end the setting.



- -20 hours to +4 hours can be set.

Setting Unit (Temperature/ Length)

Units used by this machine are set.

- 1 Press the **FUNC1** (MENU) \rightarrow **▼** (twice) \rightarrow **ENTER** key in LOCAL.
 - MACHINE SETUP MENU will be displayed.
- 2 Press the **FUNC3** (>>) .
- 3 Press **▲** **▼** to select "UNIT/TEMP." or "UNIT/LENGTH", and press the **ENTER** key.
- 4 Press **▲** **▼** to select a set value, and press the **ENTER** key.
 - Set value of tempture : °C / °F
 - Set value of length : mm / inch
- 5 Press the **END/POWER** key several times to end the setting.

Important! • Some units of the cutting plotter are still displayed in "mm".

Setting a KEY BUZZER

You can turn off the buzzer sound when pressing the key.

- 1 Press the **FUNC1** (MENU) \rightarrow **▼** (twice) \rightarrow **ENTER** key in LOCAL.
 - MACHINE SETUP MENU will be displayed.
- 2 Press the **FUNC3** (>>) twice.
- 3 Press **▲** **▼** to select "KEY BUZZER", and press the **ENTER** key.
- 4 Press **▲** **▼** to select a set value, and press the **ENTER** key.
 - Set value : ON/ OFF
- 5 Press the **END/POWER** key several times to end the setting.



• When the key buzzer is set to "OFF", the buzzer sound for errors, warnings, operation completion, etc. cannot be shut off.

Setting the CONFIRM. FEED

Set whether media feeding is performed for checking the result of the test printing etc. or not.







- 1 Press the **FUNC1** (MENU) \rightarrow **▼** (twice) \rightarrow **ENTER** key in LOCAL.
 - MACHINE SETUP MENU will be displayed.
- 2 Press the **FUNC3** (>>) twice.
- 3 Press **▲** **▼** to select "CONFIRM. FEED", and press the **ENTER** key.
- 4 Press **▲** **▼** to select a set value, and press the **ENTER** key.
 - Set value : ON/ OFF
- 5 Press the **END/POWER** key several times to end the setting.















Setting the SPACE FEED MODE



Change the feed mode of the margin included in the image data (the space of no data to be printed). If print data with much margin, set to "CONTINUOUS", then the print time can be shorten.

- 1 Press the **FUNC1** (MENU) \rightarrow **▼** (twice) \rightarrow **ENTER** key in LOCAL.
 - MACHINE SETUP MENU will be displayed.
- 2 Press the **FUNC3** (>>) twice.
- 3 Press **▲** **▼** to select "SPACE FEED MODE", and press the **ENTER** key.
- 4 Press **▲** **▼** to select a set value, and press the **ENTER** key.
 - INTERMITTENT : Perform intermittent feed operation of the path division unit
 - CONTINUOUS : Feed the no data part at a time
- 5 Press the **END/POWER** key several times to end the setting.

Set the network

- 1 Press the **FUNC1** (MENU)   (twice)  **ENTER** key in LOCAL.
 - MACHINE SETUP MENU will be displayed.
- 2 Press the **FUNC3** (>>) twice.
- 3 Press   to select "NETWORK", and press the **ENTER** key.
- 4 Press   to select "CHECK IP ADDRESS", and press the **ENTER** key.
 - The IP address currently used by this machine is displayed.
 - When you have finished the check, press the [ENTER] key.

 - After connecting with the network, it takes time until the IP address is determined. If the IP address has not been determined, "0.0.0.0" is displayed.
- 5 Press   to select "CHECK MAC ADDRESS", and press the **ENTER** key.
 - The MAC address currently used by this machine is displayed.
 - When you have finished the check, press the [ENTER] key.
- 6 Press   to select "DHCP", and press the **ENTER** key.
- 7 Press   to select a set value, and press the **ENTER** key.
 - Set value : ON/ OFF
 - When it is ON, the IP address given by the DHCP server is used.
- 8 Press   to select "AutoIP", and press the **ENTER** key.
- 9 Press   to select a set value, and press the **ENTER** key.
 - Set value : ON/ OFF
 - When it is ON, the IP address is determined by the AutoIP protocol. However, DHCP is ON, DHCP has priority.
- 10 Press   to select "IP ADDRESS", and press the **ENTER** key.
- 11 Press   to select a set value, and press the **ENTER** key.
 - Set value : ON/ OFF
 - Both of DHCP and AutoIP is OFF, you can set IP Address. For other than above, proceed to the Step 14.

- 12 Press the **FUNC3** key .
 - The setting items DEFAULT GATEWAY, DNS ADDRESS and SUBNET MASK will be displayed.
 - Both of DHCP and AutoIP is OFF, you can set DEFAULT GATEWAY/ DNS ADDRESS/ SUBNET MASK. For other than above, proceed to the Step 14.
- 13 Press the  several times to select setting item, and press the **ENTER** key.
- 14 Press   to select a set value, and press the **ENTER** key.
- 15 Press the **END/POWER** key several times to end the setting.



- To reflect network setting, once turn off the power supply and turn it on again.

Setting event mail function

Set the function to send e-mails to the set e-mail address when events such as cutting start/ end and stop due to an error.

- Disclaimer
- The customer is responsible for the communication fee for Internet communication such as e-mail notification.
- The notification by the event mail function may not be delivered due to Internet environment, failure of the device/ the power supply, etc. Mimaki has absolutely no responsibility for any damages or loss resulting from non-delivery or delays.



- You can use event mail function by connecting LAN to this machine. Please prepare for LAN cable connection beforehand.
- Not compatible with SSL communication.

Enable the event mail function

- 1 Press the **FUNC1** (MENU) \rightarrow **▼** (twice) \rightarrow **ENTER** key in LOCAL.
• MACHINE SETUP MENU will be displayed.
- 2 Press the **FUNC3** (>>) twice.
- 3 Press **▲▼** to select “EVENT MAIL”, and press the **ENTER** key.
- 4 Press **▲▼** to select “MAIL DELIVERY”, and press the **ENTER** key.
- 5 Press **▲▼** to select “ON”, and press the **ENTER** key.
- 6 Press the **END/POWER** key several times to end the setting.

Set the event to send an event mail

- 1 Press the **FUNC1** (MENU) \rightarrow **▼** (twice) \rightarrow **ENTER** key in LOCAL.
• MACHINE SETUP MENU will be displayed.
- 2 Press the **FUNC3** (>>) twice.
- 3 Press **▲▼** to select “EVENT MAIL”, and press the **ENTER** key.
- 4 Press **▲▼** to select “SELECT EVENT”, and press the **ENTER** key.
- 5 Press **▲▼** to select the event, and press the **FUNC2** (✓).
• After selecting the event, press the [FUNC2] key and put a check in the check box.
An email will be sent when the event whose box has been checked occurs.
• To select multiple events, use [**▲**][**▼**] to put the cursor over the events you want, and put a check in their boxes by pressing [FUNC2].

Event name	Outline
PRINT START	Sets sending/not sending of an email when printing starts.
PRINT END	Sets sending/not sending of an email when printing ends.
ERROR	Sets sending/not sending of an email when printing is stopped due to occurrence of an error.
WARNING	Sets sending/not sending of an email when a warning occurs during printing.
etc.	Sets sending/not sending of an email when an event other than the above occurs.

- 6 Press the **END/POWER** key several times to end the setting.

Set the e-mail address

- 1 Press the **FUNC1** (MENU) \rightarrow **▼** (twice) \rightarrow **ENTER** key in LOCAL.
• MACHINE SETUP MENU will be displayed.
- 2 Press the **FUNC3** (>>) twice.
- 3 Press **▲▼** to select “EVENT MAIL”, and press the **ENTER** key.
- 4 Press **▲▼** to select “MAIL ADDRESS”, and press the **ENTER** key.
- 5 Press **▲▼◀▶** to set mail address, and press the **ENTER** key.
• Set the e-mail address to which you send the event mail.
• Set it with alphanumeric characters and symbols within 96 characters.
- 6 Press the **END/POWER** key several times to end the setting.

Set the subject

- 1 Press the **FUNC1** (MENU) \rightarrow **▼** (twice) \rightarrow **ENTER** key in LOCAL.
• MACHINE SETUP MENU will be displayed.
- 2 Press the **FUNC3** (>>) twice.
- 3 Press **▲▼** to select “EVENT MAIL”, and press the **ENTER** key.
- 4 Press **▲▼** to select “MESSAGE SUBJECT”, and press the **ENTER** key.
- 5 Press **▲▼◀▶** to set subject, and press the **ENTER** key.
• Set the characters to write in the subject of the event mail.
• Set it with alphanumeric characters and symbols within 8 characters.
- 6 Press the **END/POWER** key several times to end the setting.

Set the server

- 1 Press the **FUNC1** (MENU) **→** **▼** (twice) **→** **ENTER** key in LOCAL.
 - MACHINE SETUP MENU will be displayed.
- 2 Press the **FUNC3** (>>) twice.
- 3 Press **▲** **▼** to select “EVENT MAIL”, and press the **ENTER** key.
- 4 Press **▲** **▼** to select “SERVER SETUP”, and press the **ENTER** key.
- 5 Press **▲** **▼** to select “SMTP ADDRESS”, and press the **ENTER** key.
- 6 Press **▲** **▼** **◀** **▶** to set SMTP Address, and press the **ENTER** key.
 - Press the jog key [**▲**][**▼**][**◀**][**▶**] to set SMTP address.
 - Input the SMTP address name.
- 7 Press **▲** **▼** to select “SMTP PORT No.”, and press the **ENTER** key.
- 8 Press **▲** **▼** to set SMTP Port No., and press the **ENTER** key.
 - Set the SMTP port number.
- 9 Press **▲** **▼** to select “SENDER ADDRESS”, and press the **ENTER** key.
- 10 Press **▲** **▼** **◀** **▶** to set SENDER ADDRESS, and press the **ENTER** key.
 - Press [**▲**][**▼**][**◀**][**▶**] and set the e-mail address to be used as the sender mail address.
 - Set it with alphanumeric characters and symbols within 64 characters.

 - Depending on your server, if you do not set the e-mail address not supporting the account, sending/ receiving e-mails may be unavailable.
- 11 Press **▲** **▼** to select “AUTHENTICATION”, and press the **ENTER** key.
- 12 Press **▲** **▼** to set authentication method, and press the **ENTER** key.
 - Set the authentication method of the SMTP server.
 - When you select [OFF], proceed to the Step 20.
- 13 Press **▲** **▼** to select “USER NAME”, and press the **ENTER** key.
- 14 Press **▲** **▼** **◀** **▶** to set User Name, and press the **ENTER** key.
 - Press [**▲**][**▼**][**◀**][**▶**] to set the user name to use for the authentication.
 - Set it with alphanumeric characters and symbols within 30 characters.
- 15 Press **▲** **▼** to select “PASSWORD”, and press the **ENTER** key.
- 16 Press **▲** **▼** **◀** **▶** to set Pass Word, and press the **ENTER** key.
 - Press [**▲**][**▼**][**◀**][**▶**] to set the password to use for the authentication.
 - Set it with alphanumeric characters and symbols within 15 characters.

 - On the password setting screen, you can only check the value that you are currently inputting.

 - When you select [POP before SMTP] in the Step 11, set the items in the Step 16 to 19.
- 17 Press **▲** **▼** to select “POP3 ADDRESS”, and press the **ENTER** key.
- 18 Press **▲** **▼** **◀** **▶** to set POP3 Address, and press the **ENTER** key.
 - Press [**▲**][**▼**][**◀**][**▶**] to set POP server.
 - Input the POP server name.
- 19 Press **▲** **▼** to select “APOP”, and press the **ENTER** key.
- 20 Press **▲** **▼** to set ON/ OFF, and press the **ENTER** key.
- 21 Press the **END/POWER** key several times to end the setting.

Send a test e-mail

- 1** Press the **FUNC1 (MENU)** \rightarrow **▼** (twice) \rightarrow **ENTER** key in LOCAL.
 - MACHINE SETUP MENU will be displayed.
- 2** Press the **FUNC3 (>>)** twice.
- 3** Press **▲▼** to select "EVENT MAIL", and press the **ENTER** key.
- 4** Press the **FUNC3 (>>)** \rightarrow **ENTER** key.
 - "TRANSMIT TEST" will be selected.

- 5** Press the **ENTER** key.
 - The sent result is displayed.
 - If sending test e-mail has failed, an error code is displayed.
Refer to the next page to solve the problem.

```
Transmit Test
Failed: 12345 :ent
```

Error code

- 6** Press the **END/POWER** key several times to end the setting.

Important!

- The sent result of the test e-mail is the result of e-mail sending process performed by this machine to the e-mail server. It does not indicate that the e-mail was received at the address.
- If the spam e-mail filter etc. has been set in the terminal in which e-mails are received, even if "Sending has been completed" is displayed, the e-mail cannot be received in some cases.
- If sending test e-mail has failed, the error code below is displayed.
- If the error cannot be solved, try again after a while.
- For the server setting etc., contact with the network administrator or the provider.

Error Code	The expected casus	Remedy
10	Network connection error	<ul style="list-style-type: none"> • Check that the machine is connected with the network. • Check that the machine IP address is correct. • Check that the machine is in the environment where DNS is available.
20	No valid e-mail address.	<ul style="list-style-type: none"> • Enter the correct e-mail address.
11003 11004	The POP server cannot be found. Or cannot access DNS server.	<ul style="list-style-type: none"> • Check the POP server address. • Check that the machine is in the environment where DNS is available.
11021	Cannot connect with the POP server.	<ul style="list-style-type: none"> • Check the POP server setting. • Check the firewall setting.
12010	An error returns from the POP server.	<ul style="list-style-type: none"> • Check the POP server setting.
13000	The POP authentication has failed.	<ul style="list-style-type: none"> • Check the user name and the password. • Check the APOP setting. • Confirm the authentication method.
10013 10014	The SMTP server cannot be found. Or cannot access DNS server.	<ul style="list-style-type: none"> • Check the SMTP server address. • Check that the machine is in the environment where DNS is available.
10021	Cannot connect with the SMTP server.	<ul style="list-style-type: none"> • Check the SMTP server setting. • Check the SMTP port number. • Check the firewall setting.
10*** 11*** 20*** 21***	An error returns from the SMTP server. Or, there was no response.	<ul style="list-style-type: none"> • Check the SMTP server setting. • Cannot communicate with a server that requires mandatory SSL communication. • Check protocol filter settings.
12***	It is invalid sender address.	<ul style="list-style-type: none"> • Check that the e-mail address supporting the account entered in the user name/ the password is set in SENDER ADDRESS.
13***	The e-mail address cannot be found. Or, it is invalid sender address.	<ul style="list-style-type: none"> • Check the e-mail address. • Even if there is a mistake in the e-mail address, this error cannot be detected in some cases. • Check that the e-mail address supporting the account entered in the user name/ the password is set in SENDER ADDRESS.
22000 22008	SMTP authentication error	<ul style="list-style-type: none"> • Confirm the authentication method.
23*** 24*** 25***	The SMTP authentication has failed.	<ul style="list-style-type: none"> • Check the user name and the password.

**** is the error code returned from the e-mail server.

Initializing the Settings

You can return the setting of “SETUP”, “MAINTENANCE” and “MACHINE SETUP” to the status before shipment.

- 1** Press the **FUNC1 (MENU)** **▶** **▼** (twice) **▶** **ENTER** key in LOCAL.
 - MACHINE SETUP MENU will be displayed.
- 2** Press the **FUNC1 (<<)**.
- 3** Press **▲** **▼** to select “RESET” , and press the **ENTER** key.
- 4** Press the **ENTER** key.
 - The already configured settings are initialized.
- 5** Press the **END/POWER** key several times to end the setting.

About NOZZLE CHECK MENU

Set operations concerning the nozzle missing detection function.

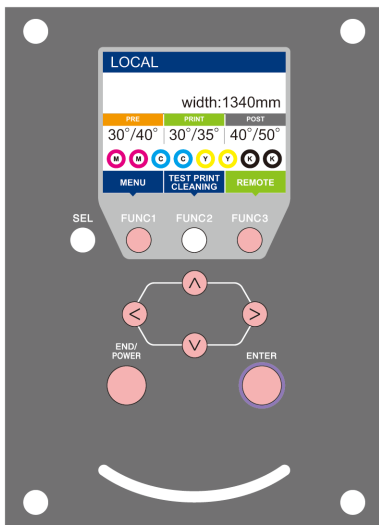

- FUNC1** : Press this to select INFORMATION MENU, or to switch to the previous screen.
- FUNC3** : Press this to switch to the next screen.
- ▲ ▼** : Use these to select a setting item.
- ENTER** : Press this to confirm a setting, etc..

◆ NCU MENUs at-a-glance

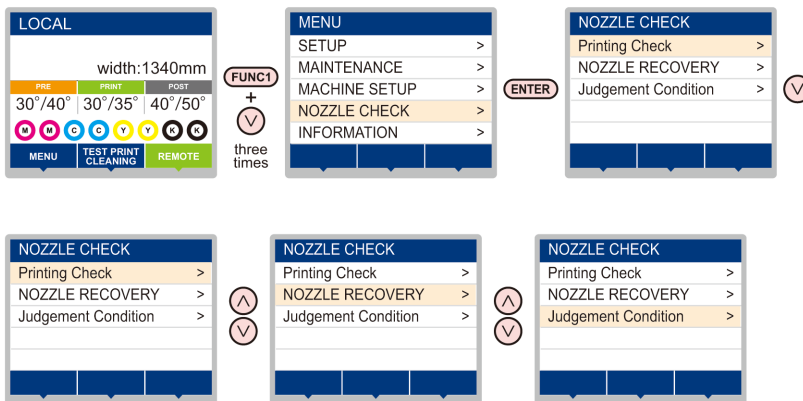

INFORMATION MENU table

Function name		Set value	Default	Meaning	
Printing Check (☞ P.3-25)		ON/OFF	OFF	Set this when you want to conduct nozzle check at the beginning of online printing.	
(ON)	Check Interval	LENGTH	0.1 to 50.0m	30.0 m	Conducts nozzle check at each set length.
		FILE	1 to 100	30 file	Conducts nozzle check at each set number of files. *1
	Action	CLEANING	OFF/ SOFT/ NORMAL/ HARD	SOFT	Sets the type of cleaning performed during recovery work.
		RETRY COUNT	0 to 3	0	Repeats the retry operation for the set number of times.
NOZZLE RECOVERY (☞ P.3-25)		ON/OFF	OFF	Set this when you want to conduct automatic nozzle recovery.	
Judgement Condition (☞ P.3-25)		1 to 180	1	Sets how many missing nozzles are detected for "Nozzle Missing" judgment to be made according to each color. (Maximum 16 per 1 nozzle line)*2	

*1. When the set length is reached during printing, nozzle check is conducted at the start of the next printing.

*2. Depending on the print conditions, nozzle recovery is not applied in some cases.

Printing Check Flow

Nozzle check is conducted according to the following flow at the start of printing.



- Turn the “Printing Check” setting ON to be enabled.
- Perform RETRY COUNT and NOZZLE RECOVERY settings only when the settings are enabled.

1 nozzle check → Judgment

Detects missing nozzles.

2 Recovery operation → nozzle check → Judgment

If more missing nozzles than “Judgment Condition” are detected after the nozzle check, cleaning is performed and nozzle check is conducted again.

3 Retry → Judgment

If more missing nozzles than “Judgment Condition” are detected after the recovery operation, the recovery operation is conducted again.

- If the “RETRY COUNT” setting is configured to 1 or more, this becomes effective.

4 Nozzle Recovery → Judgment

Nozzle recovery is automatically conducted following nozzle check and recovery operation.

- Turn the “NOZZLE RECOVERY” setting ON to be enabled.

5 Nozzle Missing judgment

If more missing nozzles than “Judgment Condition” are eventually detected, it is determined that printing can not be continued, and printing is stopped.

Printing Operations at “Nozzle Missing” Judgment and Error Occurrence

- When judged to be “Nozzle Missing” → Printing is stopped.
- When error occurs during nozzle check → Printing is stopped and “Printing Check” is automatically turned OFF. After recovering from the error, set “Printing Check” once again.

Setting the Printing Check

Select ON when you want to conduct nozzle check at the start of online printing.

- 1 Press the **FUNC1 (MENU)** \rightarrow **▼** (3 times) \rightarrow **ENTER** key in LOCAL.
 - NOZZLE CHECK MENU will be displayed.
- 2 Press **▲▼** to select “Printing Check”, and press the **ENTER** key.
- 3 Press **▲▼** to select ON, and press the **ENTER** key.
 - The “Check Interval” setting screen will be displayed.
 - “Select OFF to not set nozzle check. Proceed to Step 11.
- 4 Press the **ENTER** key.
- 5 Press **▲▼** to select setting item, and press the **ENTER** key.
 - select the nozzle check interval from “LENGTH” or “FILE”.
 - LENGTH:** nozzle check is conducted when the printed length reaches the set length.
 - FILE:** nozzle check is conducted when the number of printed files reaches the set number.
- 6 Press **▲▼** to select setting value, and press the **ENTER** key.
 - The set value will differ according to the setting selected in Step 5.
 - LENGTH:** 0.1 to 100 m
 - FILE:** 1 to 300 files
- 7 Press the **ENTER** key twice.
 - The “Action” setting screen will be displayed.
- 8 Press the **ENTER** key.
 - “CLEANING TYPE” will be selected.
- 9 Press **▲▼** to select cleaning type, and press the **ENTER** key.

Setting value: OFF/SOFT/ NORMAL/ HARD
- 10 Press **▲▼** to select retry count, and press the **ENTER** key.

Setting value: 0 to 3
- 11 Press the **END/POWER** key several times to end the setting.

Setting the NOZZLE RECOVERY

set this if you want to conduct automatic nozzle recovery when nozzle missing is detected.

- 1 Press the **FUNC1 (MENU)** \rightarrow **▼** (3 times) \rightarrow **ENTER** key in LOCAL.
 - NOZZLE CHECK MENU will be displayed.
- 2 Press **▲▼** to select “NOZZLE RECOVERY”, and press the **ENTER** key.
- 3 Press **▲▼** to select ON/OFF, and press the **ENTER** key.
- 4 Press the **END/POWER** key several times to end the setting.

Setting the Judgement Condition

Set the conditions for judging nozzle missing.

- 1 Press the **FUNC1 (MENU)** \rightarrow **▼** (3 times) \rightarrow **ENTER** key in LOCAL.
 - NOZZLE CHECK MENU will be displayed.
- 2 Press **▲▼** to select “Judgement Condition”, and press the **ENTER** key.
- 3 Press **▲▼** to select color, and press the **ENTER** key.
 - The type of color changes depending on the ink set.
 - 
- 4 Press **▲▼** to set the number of nozzles for judgment, and press the **ENTER** key.
- 5 Press the **END/POWER** key several times to end the setting.

About INFORMATION MENU

The information of this machine can be confirmed.
 The following items can be confirmed as machine information.

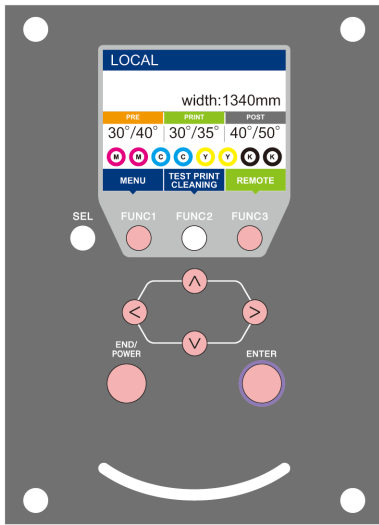

- FUNC1** : Press this to select INFORMATION MENU, or to switch to the previous screen.
- FUNC3** : Press this to switch to the next screen.
- ▲ ▼** : Use these to select a setting item.
- ENTER** : Press this to confirm a setting, etc..

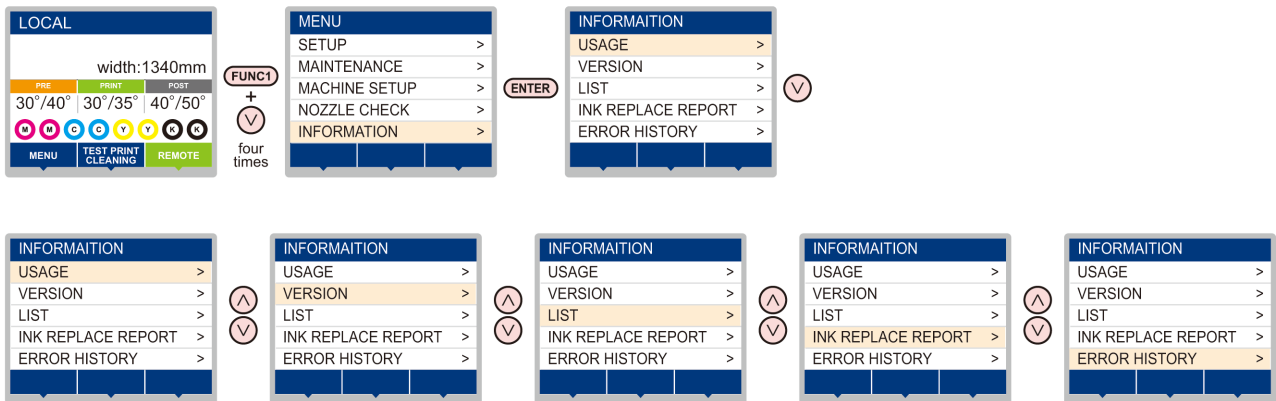

INFORMATION MENU table

Item		Description
USAGE	WIPING	This displays how many wipings have been done.
	WASTE TANK	This displays how much waste ink has built up in the waste ink tank, as a rough percentage of the tank capacity.
	PRINT LENGTH	This displays the total length of the printing done to date.
	PRINT AREA	This displays the total area of the printing done to date.
	USE TIME	This displays the total time for which the machine has been used to date.
	Spout Rubber	This displays the total time for which Spout Rubber has been used. (Only displayed when MBIS is used)
VERSION		This displays the version information of this machine.
LIST		This allows you to print the settings of this machine.
Ink REPL. Report		This prints ink history of this machine.
ERROR HISTORY		This displays the history of errors and warnings to date. When you press [▲][▼], the date of occurrence (year/month/day/hour/minute) and the error/warning information are displayed alternately in the order of occurrence.

Displaying the Information

- 1** Press the **[FUNC1] (MENU)** → **[▼]** (4 times) → **[ENTER]** key in **LOCAL**.
 - INFORMATION MENU will be displayed.
- 2** Press **[▲]** **[▼]** to select a information.
 - Refer to the “INFORMATION MENU”, and select the information to be displayed.
- 3** Press the **[ENTER]** key.
 - If you selected [LIST] in step 2, the machine’s settings will be printed.
- 4** Press the **[END/POWER]** key several times to end the setting.



- When you reset the used count of the wiper, press the [FUNC2] key while [RESET?] is displayed. When you press the [ENTER] key, the number of wipings is reset.
- By pressing the function key during display of “WIPING information,” “WASTE TANK information” and “Spout Rubber” in USAGE, the used counts can be reset.
 - When resetting WIPING information:** Press the [FUNC2]
 - When resetting WASTE TANK information:** Press the [FUNC1]
 - When resetting Spout Rubber:** Press the [FUNC3]

Chapter 4

Cutting Function



This chapter

describes about cutting function.

Cutting Out Data with Registration Mark	4-2	Maintenance Function	4-14
Workflow of Cutting Out Data with Registration		Maintenance of Mark Sensor	4-14
Mark	4-2	Perform SAMPLE CUT to Find out the Cause of	
Precautions in inputting data with registration		Cutting Error.	4-16
marks	4-3	Cutting a Medium into Multiple Pieces with a	
Setting of Detecting the Registration Marks	4-5	Certain Length	4-16
Detecting the printed registration mark	4-6	Cutting out Data without Register Marks (PC	
About CUTTING MENU	4-7	ORIGIN OFFSET)	4-17
Cutting MENU table	4-8	Setting the Scale Adjust	4-18
Setting the CUT MODE	4-9		
perform multiple Cuttings (Copy function)	4-9		
SETUP SUB MENU	4-10		
Setting the DIVISION CUT	4-10		
Make the media without uncut area (OVER CUT			
function)	4-12		
Other SETUP SUB MENU	4-12		
SETUP RESET	4-13		

Cutting Out Data with Registration Mark

Workflow of Cutting Out Data with Registration Mark

Prepare data with registration mark

Referring to “Precautions in inputting data with registration marks” (☞ P.4-3).

Print the printed data with registration mark

Referring to “Workflow of printing” (☞ P.2-2).

Prepare for cutting

Referring to “Setting a Media” (☞ P.2-4)~ “Test Cutting” (☞ P.2-29).

Register the information of the printed registration mark

Referring to “Setting of Detecting the Registration Marks” (☞ P.4-5).

Detect the registration mark origin

Referring to “Detecting the printed registration mark” (☞ P.4-6).

Cut the data with registration mark

Referring to “Printing Data” (☞ P.2-22)

Precautions in inputting data with registration marks

There are some limitations on preparing data with registration marks.

In order to make full use of this function, read the following instructions carefully and prepare data with registration marks properly.

- Important!**
- The registration mark described here is intended to detect the sheet inclination and the lengths along the X and Y axes. It is not a mark for trimming.

Size of the registration marks

The registration mark length shall be about more than ten times the line width.

In addition, for the length of a side of the registration mark against the data, refer to "The size of, and the distance between, registration marks" (P.4-4).

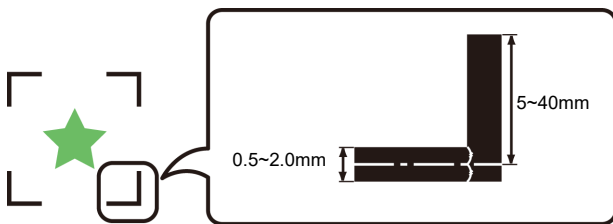

The area where registration marks and designs can be arranged

- The TP1 starting position must be 20 mm or more away from the leading edge of the sheet.
- The TP2 end position must be 45 mm or more away from the tail end of the sheet.

Mark Form : Type 1

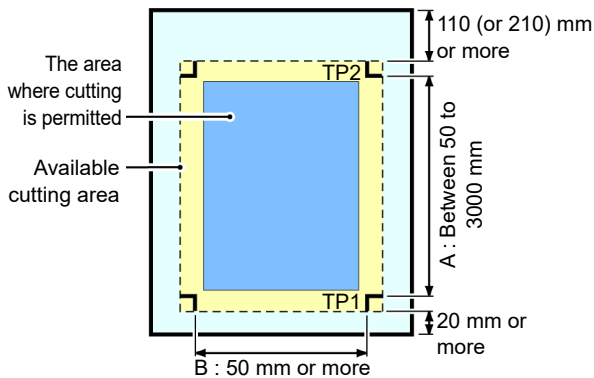

Mark Form : Type 2

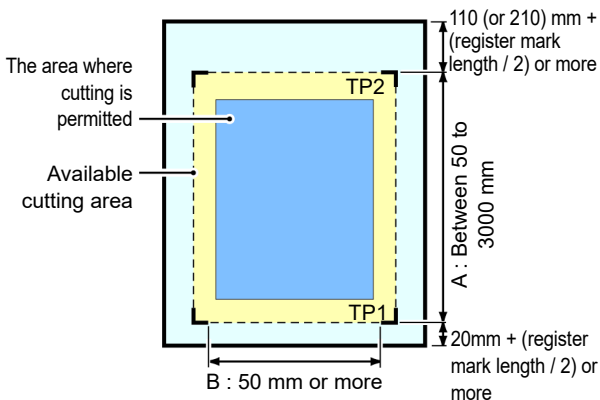

No-plotting area around the registration marks

An area around a registration mark (from the mark origin to the mark size area) is a non-plotting area. There must be no data plotted or stain in this area; otherwise, a wrong origin may be detected or a mark read error can occur.

- Important!**
- If a wrong mark origin is detected, the cutting will be performed in a wrong area.

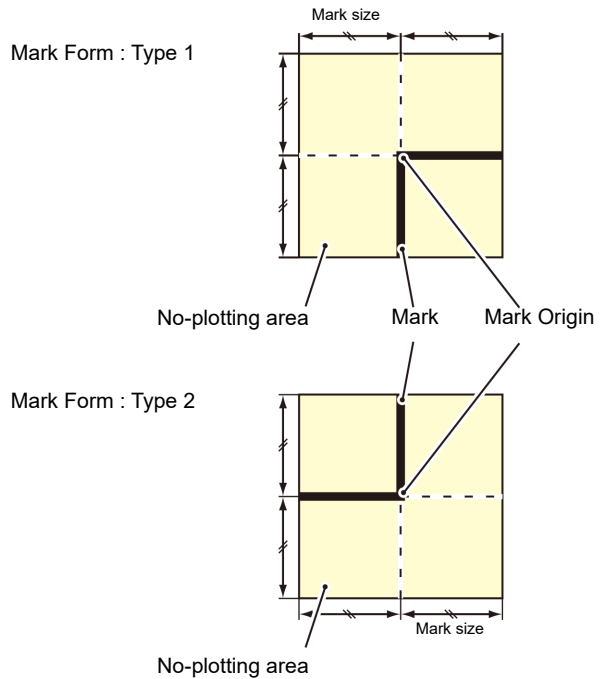

Example of cause of wrong detection 1

There is a line outside the registration marks

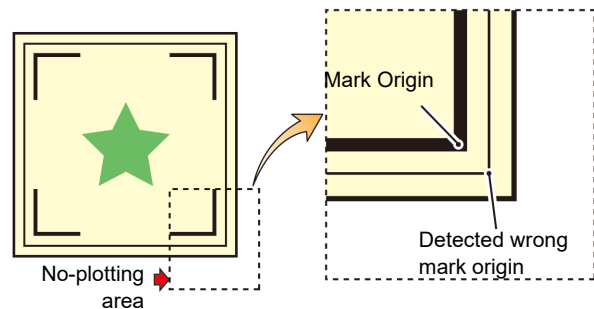

Example of cause of wrong detection 2

The distance between registration marks (TP2 and TP1 or TP4 and TP2) is smaller than the mark length (for Type 2)



The size of, and the distance between, registration marks

The size (Y) of a registration mark suited for the distance (X) between the marks is as shown below. If the mark size (Y) is too small relative to the distance (X), the marks may not be detected correctly. Be sure to prepare the registration marks with an appropriate size.

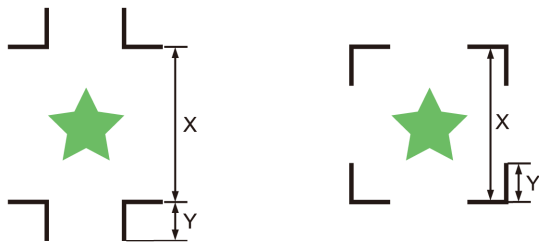

X	200 max.	500 max.	1000 max.	2000 max.	2001 min
B	5 to 40	8 to 40	15 to 40	25 to 40	35 to 40

(mm)

Distance between registration marks for copied designs

For Type 1 registration marks, the distance between the marks must be not shorter than two times the mark length and not longer than 1000 mm. For Type 2 registration marks, the distance between the marks must be not shorter than the mark length and not longer than 1000 mm.

Mark Form : Type 1

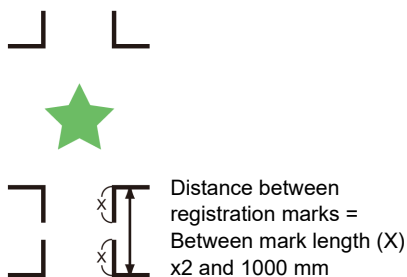

Mark Form : Type 2

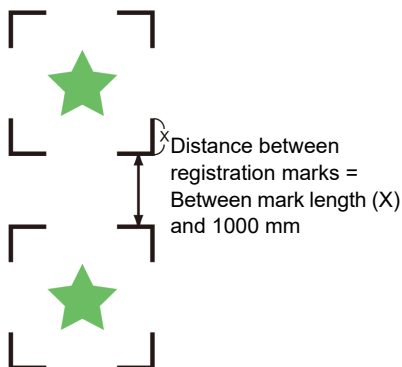

Recommended size of the area defined with a set of four registration marks

It is recommended that the size of the area defined with a set of four registration marks is in the range of A4 size (210 mm x 297 mm) to A3 size (297 mm x 420 mm). If you follow this recommendation, you can minimize wasteful spaces and arrange the designs efficiently.

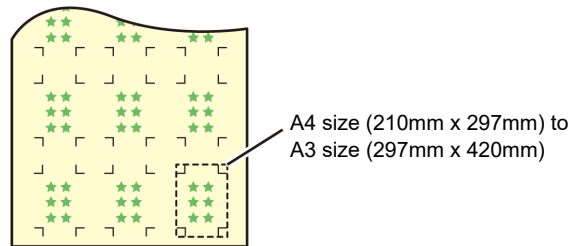

In case of perform printing a registration mark continuously

When perform printing a registration mark continuously, set the one side of the registration mark size to 8mm. In case 8mm or shorter registration mark recognized continuously, may cause the glitches on the main unit.

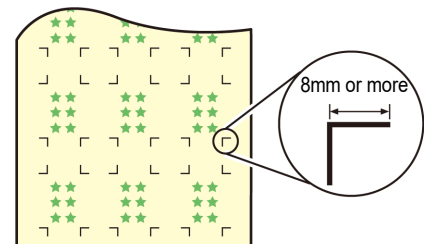

Color of mark

The mark must be printed in black against the white background.

The registration mark will not be detected correctly if the background is not white or the mark is not black.

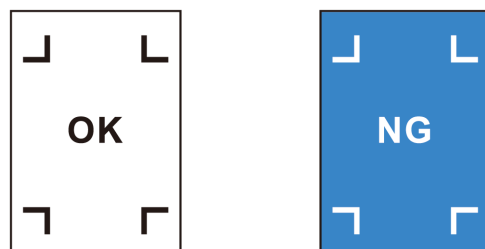

Mark blurred

If the mark is blurred, a wrong mark origin can be detected, thus resulting in deviated cutting.



Notes for the combined operation of print & cut

When performing combined operation of print & cut with RasterLink 6 or later, be careful to the following items:

(1) When performing combined operation of print & cut with the attached application software to this machine (RasterLink 6 Ver.3.0 or later / FineCut 8.4.1 or later), the following set contents will follow the instruction of software side. Note that the contents set in this machine will be invalid.

- Register mark size
- Register mark shape

(2) The combined operation of print & cut without a register mark is not performed under the following conditions:

- Print & cut using the take-up device



- Other than the above conditions, there is a possibility of the cutting line being misaligned depending on the printing data size. Therefore, it is also recommended to perform the operation with the data which has register marks for combined operation of print & cut.

Setting of Detecting the Registration Marks

When you want to cut the data with registration marks, you must set the following without fail.

- 1** Press the **[FUNC1] (MENU)** → **[FUNC3] (>>)** → **[ENTER]** key in LOCAL.
 - Cuttibg MENU will be displayed.
- 2** Press **[▲]** **[▼]** to select the "MARK DETECT", and press the **[ENTER]** key.
- 3** Press **[▲]** **[▼]** to select the setting item, and press the **[ENTER]** key.
 - Refer to "The setting items of detecting the registration marks" (P.4-5).
- 4** Press **[▲]** **[▼]** to select the setting value, and press the **[ENTER]** key.
 - **Set value** : Standard, high speed, High quality
- 5** Press the **[END/POWER]** key several times to end the setting.



- You can set the register mark detection without pressing [FUNC1] (MENU) from LOCAL.
 - (1) Press the [SEL] key in LOCAL to display "TEST CUT".
 - (2) Press [FUNC2] (TEST CUT)
 - (3) Press the [ENTER] key
 - After this, go to step 3 of "Setting of Detecting the Registration Marks".

The setting items of detecting the registration marks

There are the following seven setting items for registration mark detection.

(1) MARK DETECT

Setting	Description
ON/OFF	The registration marks can be detected if this is set to ON.

(2) MARK TYPE

Select either one of the following types of registration marks.



- Use the copy function of cutting software, in the case of continuous cut, select the register mark of Zero margin, and you will be able to place no margin between the register marks. By eliminating the margin between the register marks to cut efficiently, recommend to use register mark shaped "Zero Margin".

Setting	Description
Type 1	
Type 2	
Zero margin	

(3) MARK SIZE

Set the length of one side of the registration mark.

Length of one side



Setting	Description
5 to 40mm	When the printed mark's horizontal and vertical lengths differ from each other, set the same value as the shorter length.

(4) OFFSET Y / OFFSET X

Generally the origin will be set at the position shown below.

However, depending on your application and the work to be cut, the cutting position may be misaligned to the same direction. In this case, the location of the origin can be corrected.

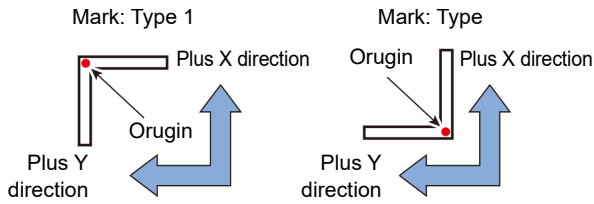

Setting	Description
± 15.00mm	Use this to shift the origin position in the X direction or Y direction.

Important! • If the origin is located out of the available cutting area, "ERR37 MARK ORG" will be displayed. In this case, write the registration marks in the area closer to the center of the media.

(5) DETECT END KEY START

Setting	Description
ON/OFF	If this is ON, you will be able to detect crop mark in [END] key.

Important! • If this is set to ON, the registration mark detection operation may be started by turning the power OFF.

(6) SENSOR LEVEL

Setting	Description
1 to 7	The bigger the numerical value is, the higher the sensitivity of the registration mark sensor becomes. If it detects the registration mark by mistake, lower the sensitivity. Generally, use it with the setting value of "4".

(7) MARK FILL UP

Setting	Description
ON/OFF	Specify the setting as "ON" when using the "Fill around the register mark" function of FineCut to detect the printed registration mark. Create using a registration mark size of 10 mm or more when filling in around the registration mark.

Detecting the printed registration mark

1 Press the **FUNC2** (TEST CUT) in LOCAL.

2 Press **▲▼** to select the "MARK DETECTION", and press the **ENTER** key.

- Turns to registration marks detection mode.
- Cutting unit moves to the platen.

3 Press **▲▼◀▶**, move the light point of the LED pointer to the center of the registration mark.

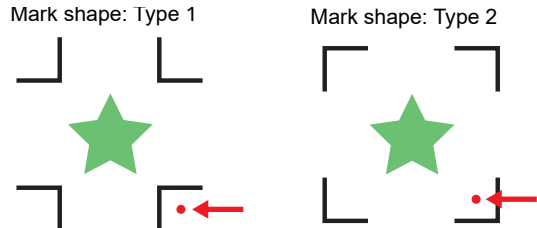

4 Press the **ENTER** key.

- Start detection of registration marks.

Cutting MENU table



- For each setting item below, you can set it so that the machine may operate according to the value specified when you printed from your RIP software in the connected host PC.
- **Set Item** : DRYING TIME/ MARGIN (LEFT and RIGHT)/ VACUUM FAN/ FEED SPEED
- When you operate the machine according to the contents specified with the RIP software, set each item to "Host" when registering this machine type. When you set it other than "Host", the machine operates according to the machine setting.
- For the specifying method with the RIP software, refer to the operation manual of the RIP software.

Function name		Outline
TP DETECT (☞ P.4-5)	MARK DETECT	When you cut the data with registration marks, you must set without fail.
	FORM	
	SIZE	
	OFFSET X	
	OFFSET Y	
	DETECT END KEY START	
	SENSOR LEVEL	
	MARK FILL UP	
CUT MODE (☞ P.4-9)		This is to set the cutting quality.
COPY (☞ P.4-9)		This function performs cutting for the received data on two or more sheets.
Tool Change (☞ P.2-25, P.2-25)		You select this function when you replace the tool.
SETUP SUB MENU	DIVISION CUT (☞ P.4-10)	You can cut the data bigger than the sheet width by dividing it. With division cut, you can make settings for the width direction (Y) and feed direction (X).
	UP SPEED (☞ P.4-12)	This is to set the speed of sheet and carriage movement when the tool is up. Setting the speed lower makes the sheet misalignment reduced at the time of long sheet feeding.
	DUMMY CUT (☞ P.4-12)	The blade edge is made to turn to a specific direction before starting cutting, which allows dummy cutting.
	SHEET TYPE (☞ P.4-12)	This is to set the types of sheet according to the sheet you use.
	ADJ PRS OFFSET (☞ P.4-12)	This is used to expand the value in such a case as when the beginning and end part of the cut are left cut.
	OVER CUT (☞ P.4-12)	By overlapping the start point and the end point arbitrarily, you can make the media without uncut area.
	CURVE MODE (☞ P.4-13)	Set the cutting speed of the curve part. When the curve part is distorted with cutting a relatively large circular arc, setting to "SLOW" may improve the situation.
	SETUP RESET (☞ P.4-13)	Reset the setting values to the initial state.
	Vacuum fan	Set the strength of the vacuum fan at cutting. Please use "weak" normally.
MAINTENANCE	MARK SENSOR (☞ P.4-14)	This is for adjusting the registration mark sensor.
	SAMPLE CUT (☞ P.4-16)	In case that normal data cutting cannot be performed etc., perform cutting with the sample stored in this machine to find out the cause of cutting error.
	AUTO CUT (☞ P.4-16)	Cutting a medium into multiple pieces with a certain length.
ORIGIN OFFSET (☞ P.4-17)		To print & cut the data without register marks, adjust the misalignment between a printed image and the cutting line.

Setting the CUT MODE

This is to set the cutting quality.

There are the following three type for cut mode.

Setting	Description
Standard	This is a regular cutting mode.
High speed	This is used to perform cutting in a short time (it is not appropriate for the heavy media).
High quality	This is a cutting mode used to give priority to cutting quality.



- Select "QUALITY" in any of the following cases:
 - Characters whose sizes are 10 mm or less are to be cut
 - Picture patterns or characters that have many sharp corners are to be cut
 - Minute cutting is to be performed
- However, the edges of finished patterns may be rugged if the data sent from the host computer is too complicated. In such a case, select "HIGHspd" for smooth finish.

Important!

- With "QUALITY", the cutting speed is limited to 20 cm/s.

1

Press the **FUNC1 (MENU)** → **FUNC3 (>>)** → **ENTER** key in LOCAL.

- Cuttbg MENU will be displayed.

2

Press **▲** **▼** to select the "CUT MODE", and press the **ENTER** key.

3

Press **▲** **▼** to select the setting value, and press the **ENTER** key.

- Set value : Standard, high speed, High quality

4

Press the **END/POWER** key several times to end the setting.

perform multiple Cuttings (Copy function)

This function performs cutting for the received data on two or more sheets. (Maximum 999 cuttings)

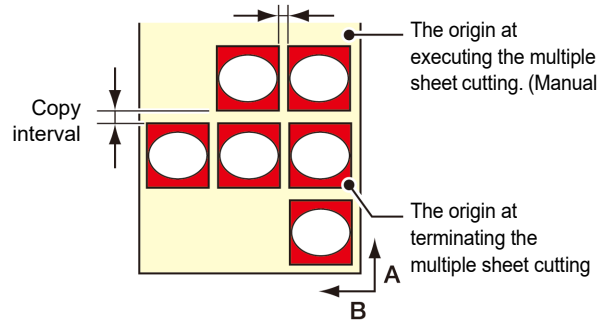

- You can perform multiple cuttings by specifying data saved in the receiving buffer of this machine.
- The receiving buffer can save only one data.
- When a new data is received, the data that has been saved is overwritten by it. (You cannot perform multiple cuttings by specifying the data that was received before.)

1

Press the **FUNC1 (MENU)** → **FUNC3 (>>)** → **ENTER** key in LOCAL.

- Cuttbg MENU will be displayed.

2

Press **▲** **▼** to select the "COPY", and press the **ENTER** key.

3

Press **▲** **▼** to select the number of cutting (1 to 999), and press the **ENTER** key.

4

Press **▲** **▼** to select the interval of figures to be cut (0 to 30mm), and press the **ENTER** key.

Important!

- If the multiple sheet cutting is executed immediately after cutting in the remote mode, cutting (plotting) will be overlapped. To avoid this trouble, be sure to set the new origin.
- While the machine is executing the multiple sheet cutting, it ignores data sent from the computer.
- To send two or more pieces of data from the computer to the machine, the data has to be sent while providing an interval of 5 seconds or more between any two pieces of data. If two pieces of data are sent from the computer to the machine within 5 seconds, the two pieces of data will be subjected to the multiple sheet cutting. The machine performs cutting for divided cutting data by the specified number of sheets without dividing the data. If any error is displayed, refer to "Error messages" (P.6-8).
- When you use FineCut, the default value of Origin Renewal is "ON". If you perform [No. COPIES], uncheck the checkbox. (Refer to FineCut OPERATION MANUAL Chapter5 "Setting Head Position after Plotting")
- This function does not support on the cutting on RasterLink.

SETUP SUB MENU

The SETUP SUB MENU offer convenient functions that you can use in cutting.

The following items are available in the sub menus.

Function name	Outline
DIVISION CUT (P.4-10)	You can cut the data bigger than the sheet width by dividing it. With division cut, you can make settings for the width direction (Y) and feed direction (X).
UP SPEED (P.4-12)	This is to set the speed of sheet and carriage movement when the tool is up. Setting the speed lower makes the sheet misalignment reduced at the time of long sheet feeding.
DUMMY CUT (P.4-12)	You can the blade edge is made to turn to a specific direction before starting cutting, which allows dummy cutting.
SHEET TYPE (P.4-12)	Set this according to the weight of the media you have set. When this is set to "HEAVY", the maximum cutting speed is set low.
ADJ PRS OFFSET (P.4-12)	This is used to expand the value in such a case as when the beginning and end part of the cut are left cut.
OVER CUT (P.4-12)	By over lapping the start point and the end point arbitrarily, you can make the media without uncut area.
CURVE MODE (P.4-13)	Set the cutting speed of the curve part. When the curve part is distorted with cutting a relatively large circular arc, setting to "SLOW" may improve the situation.
SETUP RESET (P.4-13)	Reset the setting values to the initial state.
Vacuum fan	Set the strength of the vacuum fan at cutting. Please use "weak" normally.

Setting the DIVISION CUT

When you set DIVISION CUT for the width direction (y), you can cut the data bigger than the media width by dividing it.

In addition, when you set DIVISION CUT for the feeding direction (X), you can cut the long data by dividing it and you can prevent cutting misalignment due to media meandering.

Important! With the DIVISION CUT function, you can use the following convenient functions too.

- Perform a frame cut:
Together with the cut data, the machine automatically cuts out the frame fitted to the size of the cut data.
- Put a mark for leaving a margin for gluing:
You can put a "mark" for showing the point for gluing together the DIVISION CUT medias.

Set the Y direction (width direction) DIVISION CUT

- 1 Press the **FUNC1 (MENU)** → **FUNC3 (>>)** → **ENTER** key in LOCAL.
 - Cutoff MENU will be displayed.
- 2 Press **FUNC3 (>>)**.
- 3 Press **▲ ▼** to select the "SETUP SUB MENU", and press the **ENTER** key.
- 4 Press **▲ ▼** to select the "DIVISION CUT", and press the **ENTER** key.
- 5 Press **▲ ▼** to select "Y", and press the **ENTER** key.
 - If you select "OFF", setting for division cutting will not be carried out. Proceed to step 9.
- 6 Press **▲ ▼** to select "FRAME CUT", and press the **ENTER** key.
- 7 Press **▲ ▼** to select a set value, and press the **ENTER** key.
 - Set value : ON, OFF
 - Select "ON" for the frame cut.
- 8 Press **▲ ▼** to select "MARK CUT", and press the **ENTER** key.
- 9 Press **▲ ▼** to select a set value, and press the **ENTER** key.
 - Set value : ON, OFF
 - Select "ON" for the mark cut.
- 10 Press the **END/POWER** key several times to end the setting.

Set the X direction (feeding direction) DIVISION CUT

If the data size of the feeding direction exceeds the division length and cross cut length, the machine cuts it at that position by dividing it.

If the cross cut length is set, the machine cuts by overlapping it by the set value.

- 1** Press the **FUNC1** (MENU) → **FUNC3** (>>) → **ENTER** key in LOCAL.
 - Cuttbig MENU will be displayed.
- 2** Press **FUNC3** (>>) .
- 3** Press **▲▼** to select the “SETUP SUB MENU”, and press the **ENTER** key.
- 4** Press **▲▼** to select the “DIVISION CUT”, and press the **ENTER** key.
- 5** Press **▲▼** to select “X”, and press the **ENTER** key.
 - If you select “OFF”, setting for division cutting will not be carried out. Proceed to step 10.
- 6** Press **▲▼** to select “DIV. LENG”, and press the **ENTER** key.
- 7** Press **▲▼** to select a set value, and press the **ENTER** key.
 - **Set value** : 50cm to 500 cm (in increments of 50cm)
 - When it exceeds the set value, the machine cuts it at that position by dividing it.
- 8** Press **▲▼** to select the “CROSS CUT”, and press the **ENTER** key.
- 9** Press **▲▼** to select a set value, and press the **ENTER** key.
 - **Set value** : 0mm to 50mm (in increments of 1mm)
 - The machine cuts by overlapping it by the set value.
- 10** Press the **END/POWER** key several times to end the setting.

Important!

- The setting values are kept in memory even when the power is turned off.
- During execution of division cutting, the machine ignores any other data sent from the host computer.
- In any of the following cases, the machine cannot perform division cutting.
 - The data size is larger than the receiver buffer capacity.
 - An origin change command is contained in the cutting data.
 - A two-point compensation value has been set.
 - The registration mark detection is being performed.
 - The machine cuts the test data stored in it.

Reset the setting for DIVISION CUT

- 1** Press the **FUNC1** (MENU) → **FUNC3** (>>) → **ENTER** key in LOCAL.
 - Cuttbig MENU will be displayed.
- 2** Press **FUNC3** (>>) .
- 3** Press **▲▼** to select the “SETUP SUB MENU”, and press the **ENTER** key.
- 4** Press **▲▼** to select the “DIVISION CUT”, and press the **ENTER** key.
- 5** Press **▲▼** to select “Setting”, and press the **ENTER** key.
- 6** Press **▲▼** to select “OFF”, and press the **ENTER** key.
- 7** Press the **END/POWER** key several times to end the setting.

Make the media without uncut area (OVER CUT function)

By overlapping the start point and the end point arbitrarily, you can make the media without uncut area. Specify the OVER CUT function (valid/invalid) and the length of the OVER CUT. If the length of the OVER CUT is set, when cut starts, cut will be performed from the position to the front by the specified length and the tool will move up going too far at the end. Additionally, you can enable the corner cut function to perform overcutting of corners other than the start and end points.

Important!

- Setting proper OVER CUT can reduce uncut area of start and end point of a media easy to bend. If too large value is set, the result may have a rupture.

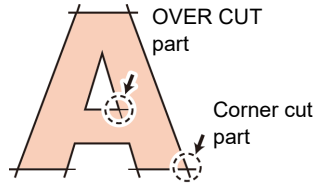

OVER CUT : OFF



OVER CUT : 1.0mm

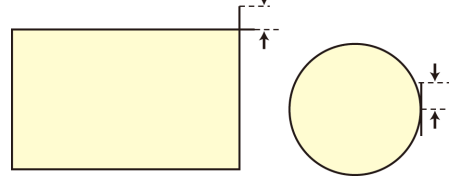

- Press the **FUNC1** (MENU) → **FUNC3** (>>) → **ENTER** key in LOCAL.
 - Cuttibg MENU will be displayed.
- Press **FUNC3** (>>).
- Press **▲▼** to select the "SETUP SUB MENU", and press the **ENTER** key.
- Press **▲▼** to select the "OVER CUT", and press the **ENTER** key.

- Press **▲▼** to select the set value, and press the **ENTER** key.
 - Set value : OFF/ 0.1 to 1.0m (in 0.1mm increment)
 - When you press the [ENTER] key, the setting for "CORNER CUT" setting will be displayed.
- Press **▲▼** to select ON/OFF, and press the **ENTER** key.
- Press the **END/POWER** key several times to end the setting.

Other SETUP SUB MENU

How to set other convenient functions is explained below. Change the settings according to the types of use.

- Press the **FUNC1** (MENU) → **FUNC3** (>>) → **ENTER** key in LOCAL.
 - Cuttibg MENU will be displayed.
- Press **FUNC3** (>>).
- Press **▲▼** to select the "SETUP SUB MENU", and press the **ENTER** key.
- Press **▼** several times, and select an item to set.
 - See "List of Settings" to select one.

- Press the **ENTER** key.
- Press **▲▼** to select a set value.
 - See "List of Settings" to select one.
- Press the **ENTER** key.
- Press the **END/POWER** key several times to end the setting.

Important!

- The set value is retained even when the power is turned "OFF".

List of Settings

The setting is as follows when purchasing:

Function Name	Overview	Set Value*1
Setting the UP SPEED	This is to set the speed of sheet and carriage movement when the tool is up. Setting the speed lower makes the sheet misalignment reduced at the time of long sheet feeding.	5,10,20,30, <u>AUTO</u> (cm/s)
Setting the DUMMY CUT (P.4-13)	the operation of dummy cutting is set.	OFF / <u>ON</u>
Setting the SHEET TYPE *2	This is to set the types of sheet according to the sheet you use.	<u>Standard</u> / Heavy
Setting the ADJ-PRS OFFSET (P.4-13)	When there is part of a media left uncut at the starting and ending points, the value is increased.	0 to <u>3</u> to 7
Setting the CURVE MODE (P.4-13)	When the curve part is distorted with cutting a relatively large circular arc with a long line segment, set to "SLOW". Distortion may improve.	<u>FAST</u> / SLOW

*1. The underlined value is set at the time of purchase.

*2. If you set "Heavy" for the media setting, the cutting speed will be limited to 20 cm/s.

Setting the DUMMY CUT

This is performed after detecting the media or when changing the tool type in front of the pinch roller which is near the both ends from the position of the cutter unit is placed presently.

Set the dummy cutting function to OFF when you do not want to damage the media in cutting cut-out characters.

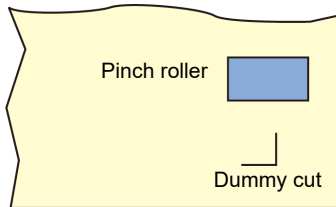

Important!

- When "PEN" is selected for the tool condition, the dummy cutting cannot be set.
- The default of the dummy cutting function is ON. When you have set the dummy cutting function to OFF, perform test cutting (P.2-29) to adjust the cutter blade orientation before cutting.

Setting the ADJ-PRS OFFSET

Some part of a media is left uncut because the pressure applied when the cutter blade touches the media is weak. When an optional eccentric blade is used, some part of a media to be cut with the blade's angle being 120 degrees or less may be left uncut.

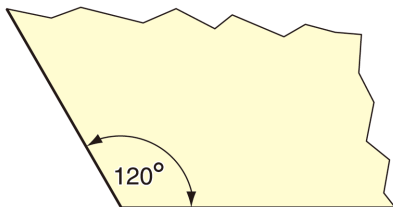

This is because the corners are cut with a low pressure (about 5 g) automatically applied so that the media does not turn up. Some part of a media may be left uncut because the blade edge does not rotate smoothly in its moving direction with the cutting pressure being low. In such a case, configure the setting for the pressure to be increased when the corners are cut.

Setting the CURVE MODE

When the curve part is distorted with cutting a relatively large circular arc with a long line segment, set to "SLOW". Distortion may improve.

- **Set value:** FAST / SLOW

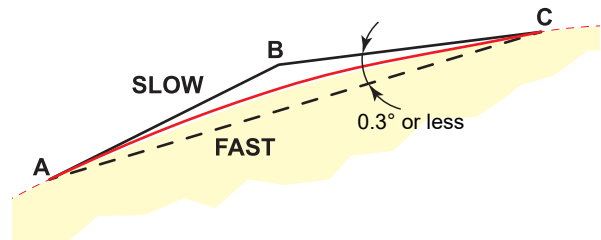

When the angle of circular arc data is 0.3 degrees or less

FAST: Cut on lines A to C.

SLOW: Cut by the line A to B to C.



- It is set to "FAST" originally. When set to "SLOW", overall the speed will be slowed with general cut data.

SETUP RESET

Reset the setting values to the initial state.

- 1 Press the **FUNC1 (MENU)** → **FUNC3 (>>)** → **ENTER** key in LOCAL.
 - Cuttbg MENU will be displayed.
- 2 Press **FUNC3 (>>)**.
- 3 Press **▲ ▼** to select the "SETUP SUB MENU", and press the **ENTER** key.
- 4 Press **▼** several times, and select an item to set.
 - See "List of Settings" to select one.
- 5 Press **>>** and press the **▼** twice.
 - "SETUP RESET" will be selected.
- 6 Press the **ENTER** key.
 - The already configured settings are initialized.
- 7 Press the **END/POWER** key several times to end the setting.

Maintenance Function

This section gathers together the functions for checking/adjusting the cutting accuracy when cutting does not go normally.

Function name	Outline
MARK sensor (☞ P.4-14)	Adjusting the registration mark sensor.
SAMPLE CUT (☞ P.4-16)	In case that normal hanaokadata cutting cannot be performed etc., perform cutting with the sample stored in this machine to find out the cause of cutting error.
AUTO MEDIA CUT (☞ P.4-16)	You can cut a medium into multiple pieces with a certain length.
PC ORIGIN OFFSET (☞ P.4-17)	Adjust the misalignment between the print origin and the cutting origin.
SCAKLE ADJUST (☞ P.4-18)	When printing and cutting without registration marks, adjustment is performed if the misalignment in the scanning direction occurs between the left and right edges of the media.

Maintenance of Mark Sensor

If cutting does not go normally, check the items below. In registration mark sensor maintenance, you can carry out maintenance of the following items.

Item	Outline
SENSOR CHECK (☞ P.4-14)	checking the sensor for the register mark detection.
POINTER OFFSET (☞ P.4-15)	If the cutter unit fails to recognize any register mark properly, the possible cause is an error in the positional relationship between the mark sensor and the light pointer. In this case, correct the position of the light pointer.

Check the sensor for the registration mark detection

Prepare the media on which the registration mark is printed.

Important!

- If you move the head and sheet manually, you cannot perform the right response check. Be sure to perform it via the following operations.
- For conditions of already printed registration mark, refer to "Precautions in inputting data with registration marks" (☞ P.4-3).
- The setting values are kept in memory even when the power is turned off.
- The settings performed here for shape of the registration mark and length of the registration mark are reflected in the settings of "MARK DETECT". (☞ P.4-5)
- The detection speed selected here will be used in the registration mark detection operations that are executed from here on.
- The pointer offset value selected by this operation is not initialized by SETUP RESET operation.

1 Press **▲▼◀▶** in Local.

- Enter the jog mode

2 Press **▲▼◀▶** to move the tip of the pen to the registration mark detection position

- Perform registration mark detection at a position 1mm or more away from the registration mark.

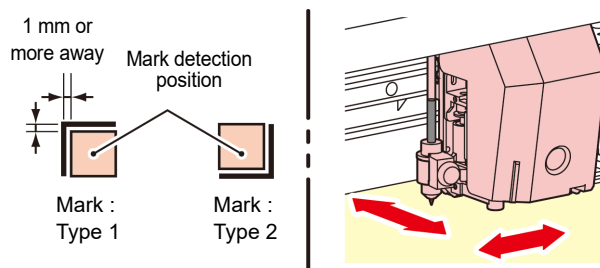

3 Press the **END/POWER** key to terminate the jog mode.

- The machine returns to the Local.

4 Press the **FUNC1 (MENU) → FUNC3 (>>)**

ENTER key.

- Cuttbg MENU will be displayed.

5 Press **FUNC3 (>>)**.

6 Press **▲▼** to select the "MAINTENANCE", and press the **ENTER** key.

7 Press **▲▼** to select "MARK SENSOR", and press the **ENTER** key.

8 Press **▲▼** to select "SENSOR CHECK", and press the **ENTER** key.

9 Select the length of the registration mark and shape of the registration mark detection.

- For details on setting the [SIZE] and [FORM], refer to the "Setting of Detecting the Registration Marks". (☞ P.4-5)

10 Press the **ENTER** to perform registration mark detection. (☞ "Detect operation")

■ Detect operation

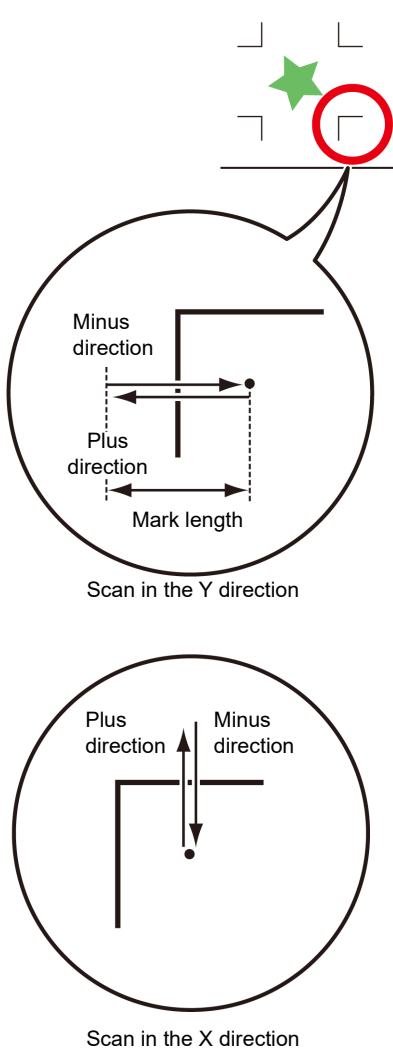

- 1** Scan in the X direction (plus direction) to detect the line.
 - The buzzer sounds when the line is detected. If the line is not detected, the buzzer does not sound.
- 2** Scan in the X direction (minus direction) to detect the line.
- 3** Scan in the Y direction (plus direction) to detect the line.
- 4** Scan in the Y direction (minus direction) to detect the line.
- 5** Follow the Steps 1 to 4, and confirm if the buzzer sounds 4 times.
 - When the detection behavior completes successfully, the buzzer sounds 4 times.
 - If the buzzer does not sound, contact our sales office after checking the registration mark condition.

Correct the light pointer position

If the machine fails to recognize any registration mark properly, the possible cause is an error in the positional relationship between the MARK sensor and the light pointer.

In this case, adjust the position of the light pointer.

- 1** Install a cutter in the tool holder.
- 2** Load the copy paper.

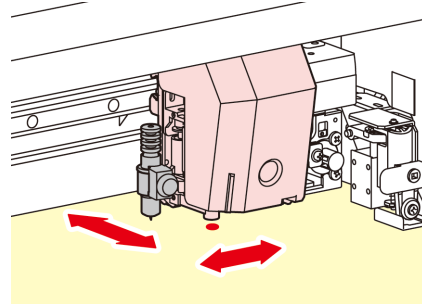

- 3** Press the **FUNC1 (MENU)** → **FUNC3 (>>)** → **ENTER** key in LOCAL.
 - Cutting MENU will be displayed.
 - 4** Press **FUNC3 (>>)**.
 - 5** Press **▲** **▼** to select the "MAINTENANCE", and press the **ENTER** key.
 - 6** Press **▲** **▼** to select "MARK SENSOR", and press the **ENTER** key.
 - 7** Press **▼** twice to select "POINTER OFS".
 - 8** Press the **ENTER** key.
 - A 10 mm by 10 mm cross pattern will be cutted.
 - The light pointer turns on and moves to the center of the cross pattern.
 - 9** Press **▲** **▼** **◀** **▶** to adjust the light pointer position so that the center of the light pointer is in alignment with the center of the cross pattern.
 - 10** Press the **ENTER** key.
 - The machine will return to the local after registering the compensation value.
- Important!** • The value registered in the [POINTER OFS] is not initialized even by executing the "SETUP RESET". (P.4-13)

Perform SAMPLE CUT to Find out the Cause of Cutting Error.

In case that normal data cutting cannot be performed etc., perform cutting with the sample stored in this machine to find out the cause of cutting error.

Sample "Cut"

Cut

Sample "Logo"

MIMAKI

Important!

• Execution of SAMPLE CUT will clear the data in the receiver buffer.

- 1** Press the **FUNC1 (MENU)** → **FUNC3 (>>)** → **ENTER** key in LOCAL.
 - Cuttibg MENU will be displayed.
- 2** Press **FUNC3 (>>)** .
- 3** Press **▲ ▼** to select the "MAINTENANCE", and press the **ENTER** key.
- 4** Press **▲ ▼** to select the "SAMPLE CUT", and press the **ENTER** key.
- 5** Press **▲ ▼** to select the SAMPLE DATA to be cut.
 - There are two types of samples, "Cut" and "Logo." If you select "Cut," proceed to Step 7.
- 6** Press the **ENTER** key.
- 7** Select scale factor using **▲ ▼** to cut Logo.
 - Scale factor : 1 to 999%
- 8** Press the **ENTER** key for starting cutting.

Result of SAMPLE CUT

Sample data can be cut successfully, but other data cannot.

- The host computer is faulty.

Sample data as well as other data cannot be successfully cut either.(When leaving the start/end lines without cutting off)

- Increase the set value of [ADJ-PRS OFS] to raise the pressure for pressing the cutter blade down.

Cutting a Medium into Multiple Pieces with a Certain Length

You can cut a medium into multiple pieces with a specified length. (Automatic media-cutting function)

Function name	Outline
Cutting interval	Setting the interval for cutting the media.
Leading end adjustment cutting	Setting the length for cutting the medias' leading edges before auto media cut starts. With edge match cutting, the specified number of media sheets can be cut at equally spaced intervals, even if their leading edges were previously cut to be slanted or uneven.
Number of times a medium is cut	Setting the number of times (sheets) for media cutting.

- 1** Press the **FUNC1 (MENU)** → **FUNC3 (>>)** → **ENTER** key in LOCAL.
 - Cuttibg MENU will be displayed.
- 2** Press **FUNC3 (>>)** .
- 3** Press **▲ ▼** to select the "MAINTENANCE", and press the **ENTER** key.
- 4** Press **▲ ▼** to select the "MEDIA CUT", and press the **ENTER** key.
- 5** Press **▲ ▼** to select a cutting interval, and press the **ENTER** key.
 - Set value : 10 to 10,000 mm
- 6** Press **▲ ▼** to select a length for the leading end adjustment cutting, and press the **ENTER** key.
 - Set value : 0 to 500 mm
- 7** Press **▲ ▼** to select the number of times a medium is cut (number of pieces produced by cutting a medium), and press the **ENTER** key.
 - Set value : 1 to 9,999
 - The number of cuts that you set here will be executed.
 - You can halt the cutting by pressing the [END/POWER] key.
- 8** Press the **END/POWER** key several times to end the setting.

Cutting out Data without Register Marks (PC ORIGIN OFFSET)

Adjust the misalignment between printing and cutting by Print & Cut.

Print the adjustment pattern from RasterLink6, and enter the adjustment values to the printer.

For Print & Cut without registration marks

- 1 Set the machine to "REMOTE" status.
- 2 Set the print conditions (profile, cut conditions) of the job that you want to print using RasterLink6.
- 3 Click [print & cut Origin adjust] in the [Cut edit] tab of RasterLink6.

- Click [OK] to print the adjustment pattern.

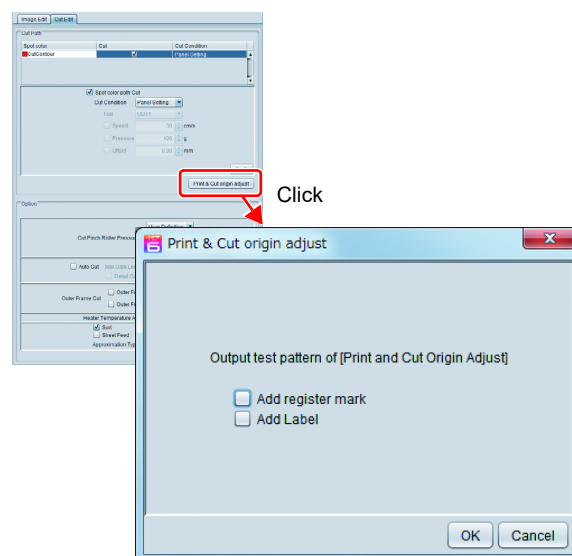

- 4 When the pattern is printed, press **FUNC1** (ADJUST) and select "PC ORIGIN OFFSET".

- When the media is fed, peel the cut part of the pattern, and check the adjustment values

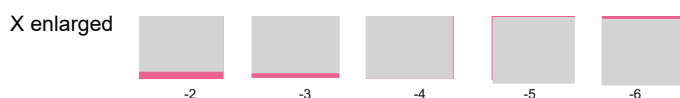
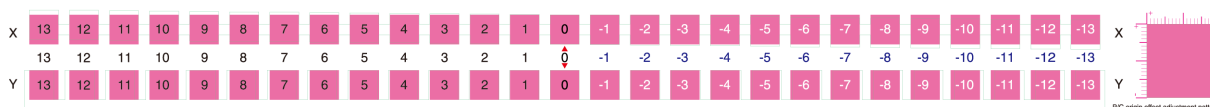

Enter the value of the position that has the least misalignment between top and bottom. The example here shows that -4 has the least misalignment, so enter "4".



Enter the value of the position that has the least misalignment between right and left. The example here shows that 2 has the least misalignment, so enter "2".

- 5 Enter the adjustment values

- When you press the [ENTER] key, the media return, and the operation is completed.

Important!

- When printing the data that has a different resolution (Y), make adjustment again. (Save an adjustment value per resolution)
- You cannot print adjustment patterns with multiple conditions continuously, and enter the adjustment values. Make sure you print and set one adjustment value per condition.



- To adjust again, perform a test cut once, and then adjust from step 1.

For Print & Cut with registration marks

- 1 Set the machine to "REMOTE" status.
- 2 Set the print conditions (profile, cut conditions) of the job that you want to print using RasterLink6.
- 3 Click [print & cut Origin adjust] in the [Cut edit] tab of RasterLink6.
- 4 Select "Add registration mark".
 - Click [OK] to print the adjustment pattern.
- 5 When the pattern is printed, press **(FUNC1) (ADJUST)** and select "TP OFFSET".
 - When the media is fed, peel the cut part of the pattern, and check the adjustment values (The actual pattern has registration marks.)

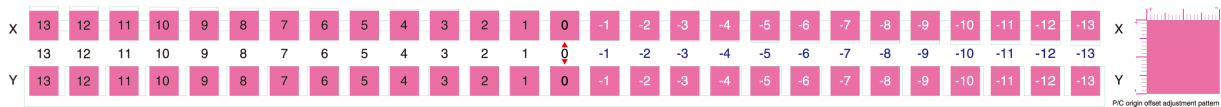

X enlarged

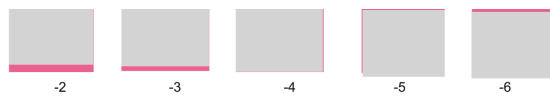

Enter the value of the position that has the least misalignment between top and bottom
The example here shows that -4 has the least misalignment, so enter "-0.40".

Y enlarged



Enter the value of the position that has the least misalignment between right and left
The example here shows that 2 has the least misalignment, so enter "0.20".

- 6 Enter the adjustment values
 - When you press the [ENTER] key, the media return, and the operation is completed.

Setting the Scale Adjust

When printing and cutting without registration marks, adjustment is performed if the misalignment in the scanning direction occurs between the left and right edges of the media.
When you perform scale adjustment, adjustment is performed automatically.

- 1 Set a media (☞ P.2-4)
 - Set the white media for printing the correction pattern.
 - 2 Press the **(FUNC1) (MENU)** ➔ **(FUNC3) (>>)** ➔ **(ENTER)** key in LOCAL.
 - Cutoff MENU will be displayed.
 - 3 Select [Maintenance], press **(▲)** **(▼)** to select the "SCALE ADJUST", and press the **(ENTER)** key.
 - 4 After the confirmation screen appears, press the **(ENTER)** key.
 - After the correction pattern is printed, the pattern is automatically corrected by detecting the registration mark.
- Important!** • Adjust the resolution to match the resolution you want to print (Y540dpi or Y360/720dpi).

Chapter 5

Maintenance



This chapter

describes the items required to use this machine more comfortably, which are the methods for the daily care, the maintenance of the ink cartridges etc.







Maintenance	5-2	Nozzle Recovery Function	5-13
Precautions for Maintenance	5-2	Reset the set value	5-14
About Cleaning Solution.....	5-2	Automatic Maintenance Function	5-15
Cleaning the Exterior Surfaces	5-2	Setting the Refreshing Intervals	5-15
Cleaning the Platen	5-2	Setting the Pump Tube & Nozzle Wash Intervals	5-15
Cleaning the Media Sensor	5-3	Setting the Cleaning Intervals and Type	5-16
Cleaning the Media Press	5-3	Fill up Ink	5-16
Cleaning the Jam Sensor	5-3	Ink Maintenance	5-17
Replacing the exhaust BOX filter or exhaust BOX.	5-3	White Ink Maintenance	5-17
Replace the CP pad set.	5-4	Replacing consumables	5-17
Replacing the pen line rubber or pen line sponge.	5-5	Replacing the wiper	5-17
Cleaning and replacing the pinch roller.....	5-5	If a Waste Ink Tank Confirmation Message Appears	5-18
About MAINTENANCE MENU	5-6	Replacing the waste ink tank before the waste ink tank confirmation message is displayed	5-19
MAINTENANCE MENUs at-a-glance	5-7	Replacing the Cutter Blade	5-19
Daily care other than the maintenance menu	5-7	Replacing and Adjusting the Cutter Blade ..	5-20
Maintaining the Capping Station	5-8	Replacing the cutter	5-20
Cleaning the Wiper and Cap	5-8	Adjusting the Cutter Blade	5-21
Washing the Head Nozzle	5-9	Replacing the cutter other than supplied one	5-21
Washing the Ink Discharge Passage	5-10	Adjusting blade edge of cutter other than supplied one	5-21
When the Machine Is Not Used for a Long Time	5-10		
Cleaning the Ink Head and the Area around It	5-12		

Maintenance

Maintain the machine regularly or as necessary so that its accuracy will be maintained and it can continue to be used for a long time.

Precautions for Maintenance

Pay attention to the following items when maintaining this machine.

- 
 - Turn off the main power and unplug the power cable before maintenance.
- | | |
|--|--|
| 
 | <ul style="list-style-type: none"> • Pay close attention to ventilation and be sure to wear the included safety glasses and gloves provided, and the filtering face mask, when handling ink, maintenance cleaning solution, waste ink, or other solutions used in this machine. Failure to do so may result in ink or other liquids splashing and coming into contact with the skin, eyes, or mouth. |
|  | <ul style="list-style-type: none"> • Never disassemble the machine. Disassembling it can result in electric shock hazards or damage to the machine. Before maintenance, be sure to turn off the power switch and unplug the power cable; otherwise, an unexpected accident may occur. |
|  | <ul style="list-style-type: none"> • Prevent moisture from entering the machine. Moisture inside the machine can cause electric shock hazards or damage to the machine. |
|  | <ul style="list-style-type: none"> • To ensure stable ink jetting, it is necessary for the machine to eject a small amount of ink (flushing) regularly when a printing (outputting) operation has not been performed for a long time. • When the machine is not to be used for a long time, turn off only the power switch on the front side, leave the main power switch at the right side turned ON (in the position of), and leave the power cable connected. |
|  | <ul style="list-style-type: none"> • Do not wipe the nozzle face of the heads, wiper, caps, etc. with water or alcohol. Doing so can cause nozzle clogging or machine failure. • Do not use benzine, thinner, or any chemical agent containing an abrasive. Such materials can deteriorate or deform the surface of the cover. • Do not apply a lubricant, etc. to any parts inside the machine. Doing so can cause printing failure. • Be careful that the cleaning solution, ink, etc. not to stick to the cover because this may cause the surface of the cover to deteriorate or deform. |

About Cleaning Solution

Use the cleaning liquid dedicated for the ink being used.

Type of Ink	Applicable maintenance washings
BS3/ BS4 ink	Cleaning solution MS2/ES3/HS kit 200 (SPC-0369) [Sold separately]

Cleaning the Exterior Surfaces

When the exterior surfaces of the machine are stained, dampen a soft cloth with water or a neutral detergent diluted with water, squeeze it, and wipe the surfaces with the cloth.

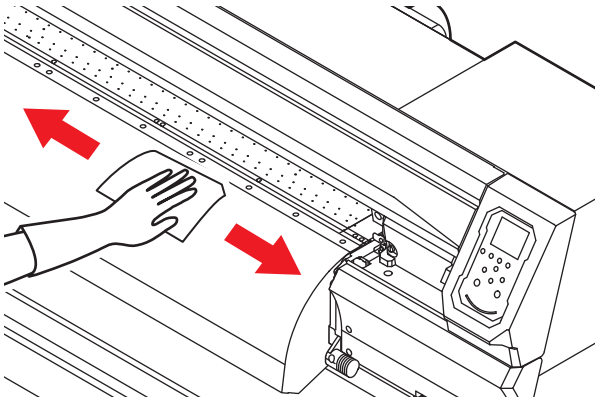



Cleaning the Platen

- 
 - Turn off the main power and unplug the power cable before maintenance.

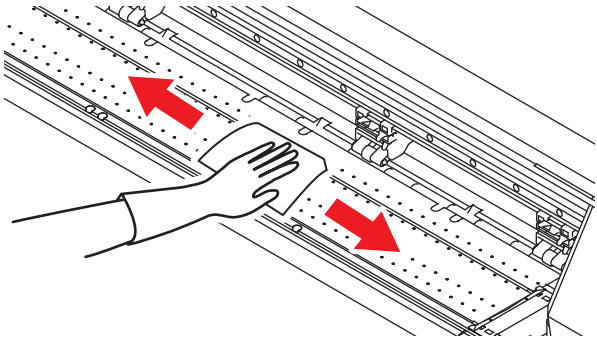
Continuing to use the media while it is dirty may cause media to be fed incorrectly, or rubbing dirt or solid ink onto the head nozzle surface, resulting in discharge failure (nozzle clogging, deflection, etc.).



- 
 - Do not allow liquids to enter the machine. There is a risk of equipment failure, electric shock, or fire.
- 
 - If the dirt is noticeable, use a soft cloth soaked in a neutral detergent diluted with water, wrung out, and then wiped off.
 - Before cleaning the platen, make sure that the platen has cooled adequately.
- 
 - The groove that slides the media press and the groove that cuts the media are particularly easy to collect dust. Please carefully remove the dust.

Cleaning the Media Sensor

The media sensors are located on the platen in the backside and the bottom surface of the head. When the sensor is covered with dust, etc., it may cause false detection of media.

Using a cotton swab, remove the dust, etc. accumulated on the surface of the sensor.

When cleaning the sensor on the lower surface of the head is cleaned, move the carriage to the left end by the operations of step 1 of P.5-12 "Cleaning the Ink Head and the Area around It", and clean it.

The backside of the machine

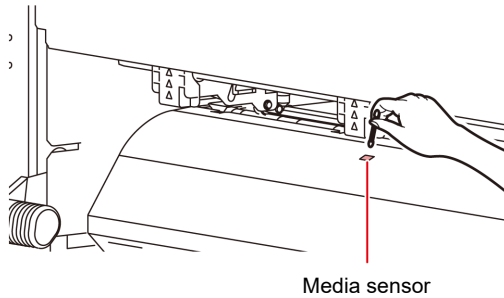

The lower surface of the head

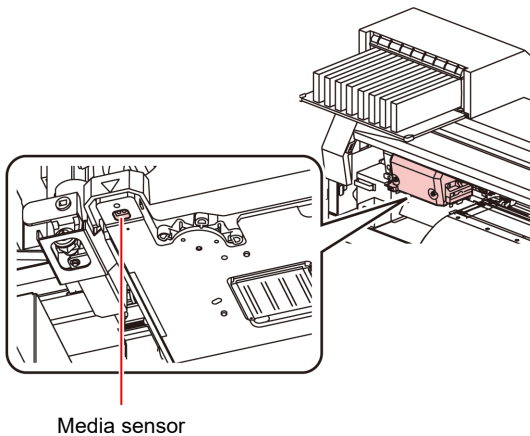

- Don't touch the cutter around the media sensor. Sharp cutter tip may injure you.

Cleaning the Media Press

When the media press is covered with lint, dust, etc., a media cannot be fed normally during printing or dust sticks to the nozzles, which may result in abnormal printing.

Clean the media press regularly.

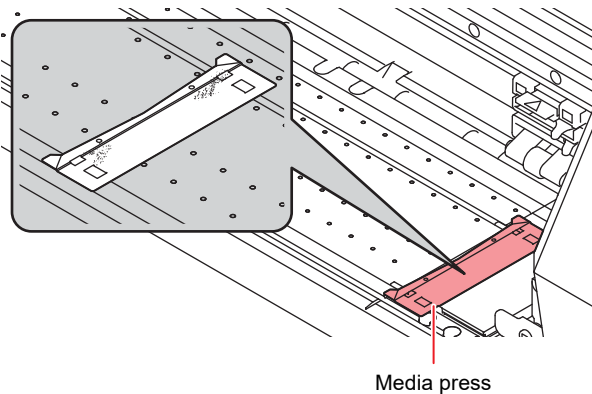

Cleaning the Jam Sensor

The jam sensor unit is attached to the right side of the carriage. If ink stains or dust accumulate on the sensor unit, it may cause a media jam. Clean the jam sensor periodically.

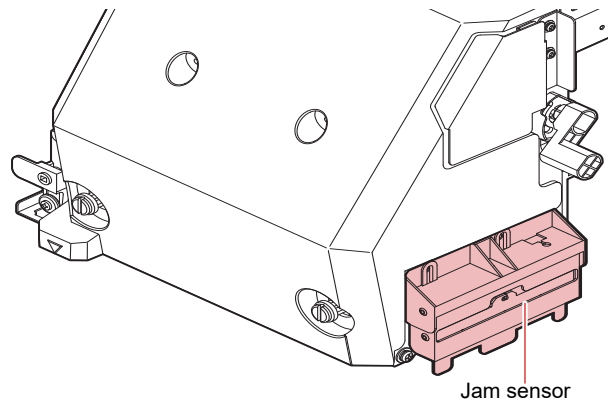

Replacing the exhaust BOX filter or exhaust BOX.

Replace the exhaust BOX filter (product number: SPA - 0249) or the exhaust BOX (product number: SPA - 0248) when it is dirty with ink.

1 Remove the tabs (2 locations) on the exhaust BOX.

- There are tabs engaged at the rear of the exhaust box also.

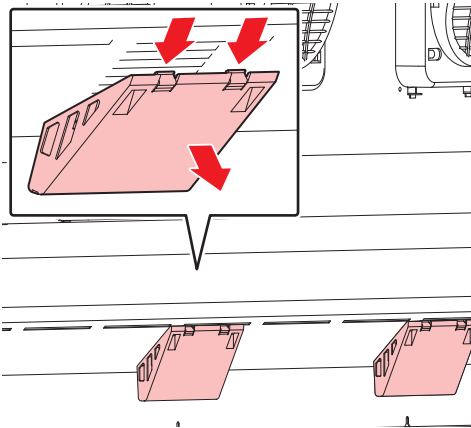

2 Remove the exhaust BOX and exhaust BOX filter.

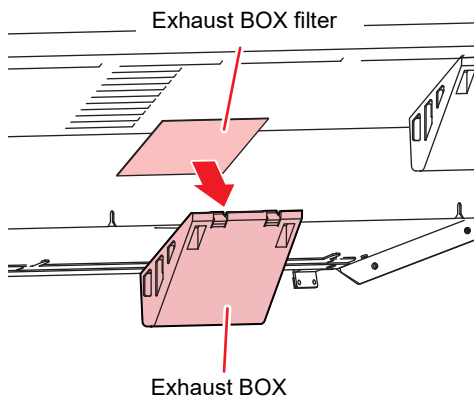

3 Replace the exhaust BOX filter or the exhaust BOX with a new one.

4 Attach the exhaust BOX filter to the exhaust BOX.

- Insert the exhaust BOX filter in the exhaust BOX tabs.

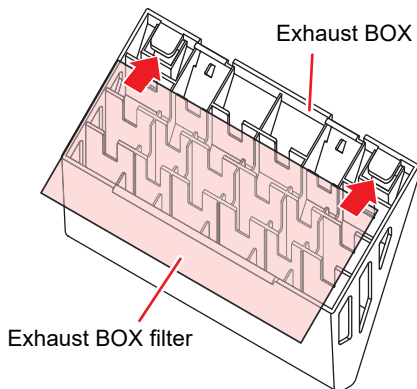

5 Attach the exhaust BOX to its original location.

- Engage the exhaust box rear tabs into the machine body, then push in the front part of the box.

Replace the CP pad set.

Replace CP pad set (SPA-0257) when it is dirty.

1 Push up the tabs (2places) of CP pad Assy.

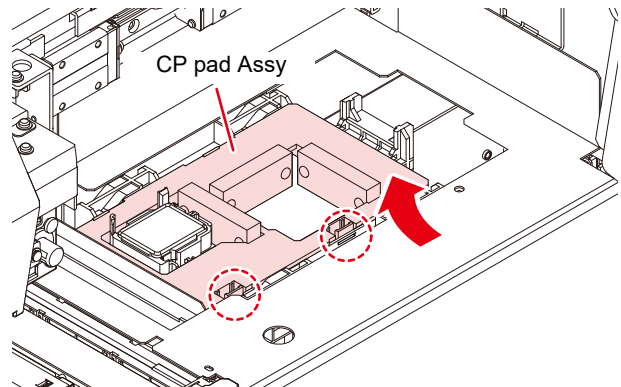

2 Remove the CP pad Assy.

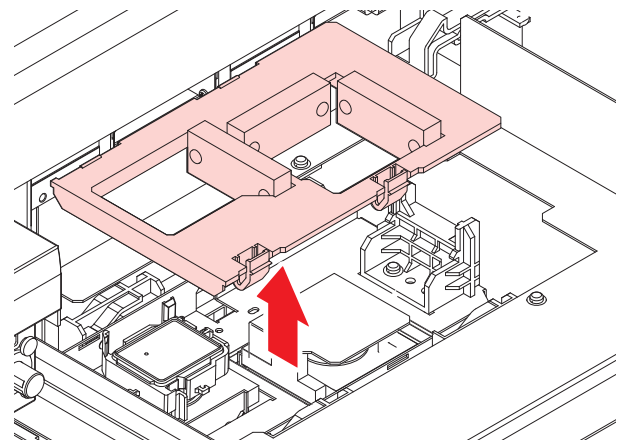

3 Attach a new CP pad Assy.

- After inserting the tabs of CP pad Assy to the slit of C slider, fit the whole.

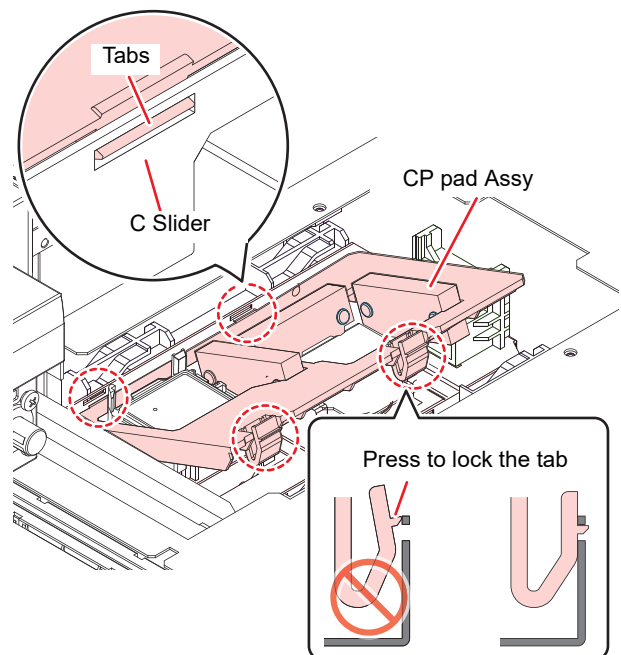

Replacing the pen line rubber or pen line sponge.

There are two types of pen line, one is rubber type and the other is sponge type.

Use the pen line rubber when writing with a pen or cutting a sheet.

Use the pen line sponge when cutting on the dotted line (half cut).

If the pen line rubber (PN: SPC-0770 or SPC-0771) or pen line sponge gets worn, replace it (PN: SPC-0775 or SPC-0776).

1 Remove a pen line rubber or pen line sponge with tweezers.

- If double-sided tape glue remains in the groove of this machine, wipe off the glue with alcohol.

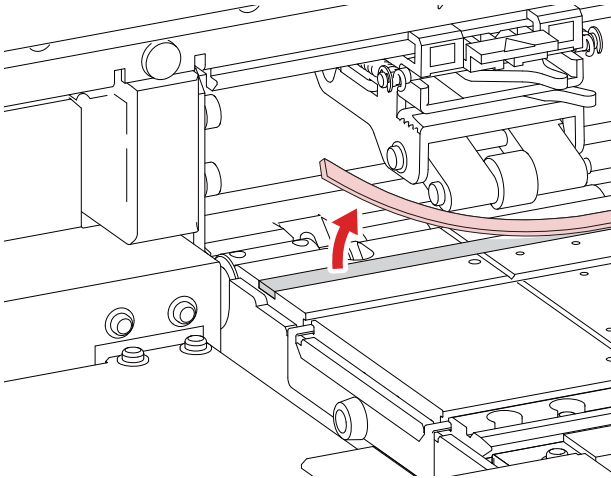

2 Attach the attached double-sided tape to the groove of this machine.

3 Put a new pen line rubber or pen line sponge on double-sided tape.

- Put a new pen line rubber or new pen line sponge flattened on the two-sided tape.

Cleaning and replacing the pinch roller.

Clean the pinch roller (product number: SPA-0166 or SPA-0167) when it is dirty.

Also, when the pinch roller wears out or the dirt of the pinch roller does not fall, replace the pinch roller.

1 Raise the clamp lever.

2 Raise the clamp lever.

Important!

- Be careful not to drop the parts in the gap of the machine as they are small.

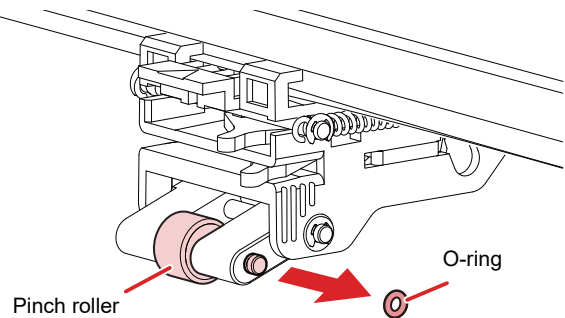

3 Pull out the Pinch Roller shaft with care not to drop the pinch roller.

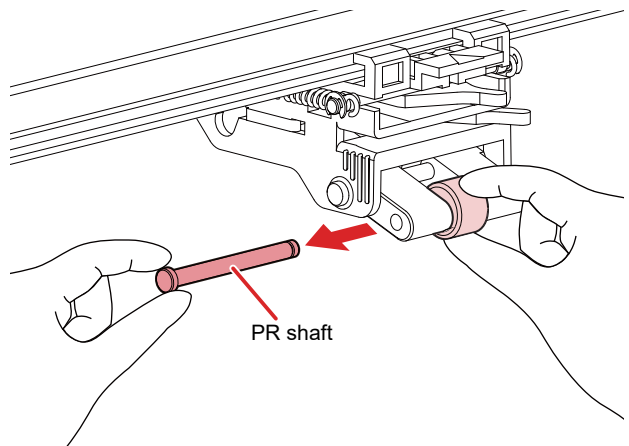

4 Remove the pinch roller.

5 Clean or replace the O-ring and pinch roller.

- Wipe off the ink sticking to the O-ring and pinch roller with a clean stick dipped in cleaning solution for maintenance. Wipe off so that cleaning solution for maintenance will not remain.
- If it does not become clean even after cleaning, replace the pinch roller with the following procedure.
 - (1) Install a new pinch roller.
 - (2) Insert the PR axis and fit O ring.

About MAINTENANCE MENU

This provides various settings for doing maintenance on the machine.
The following items can be set in Maintenance settings.

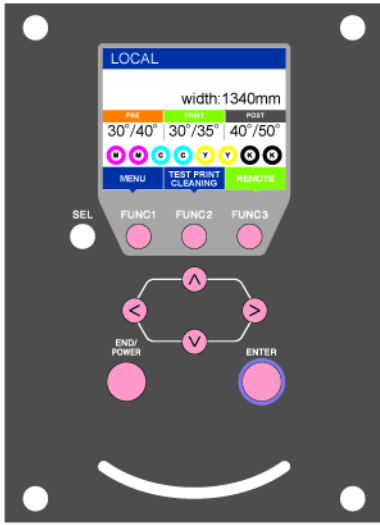

- FUNC1** : Press this to select MAINTENANCE MENU, or to switch to the previous screen.
- FUNC2** : Press this to use the maintenance function.
- FUNC3** : Press this to switch to the next screen.
- ▲ ▼** : Use these to select a setting item.
- ENTER** : Press this to confirm a setting, etc..

◆ MAINTENANCE MENUs at-a-glance

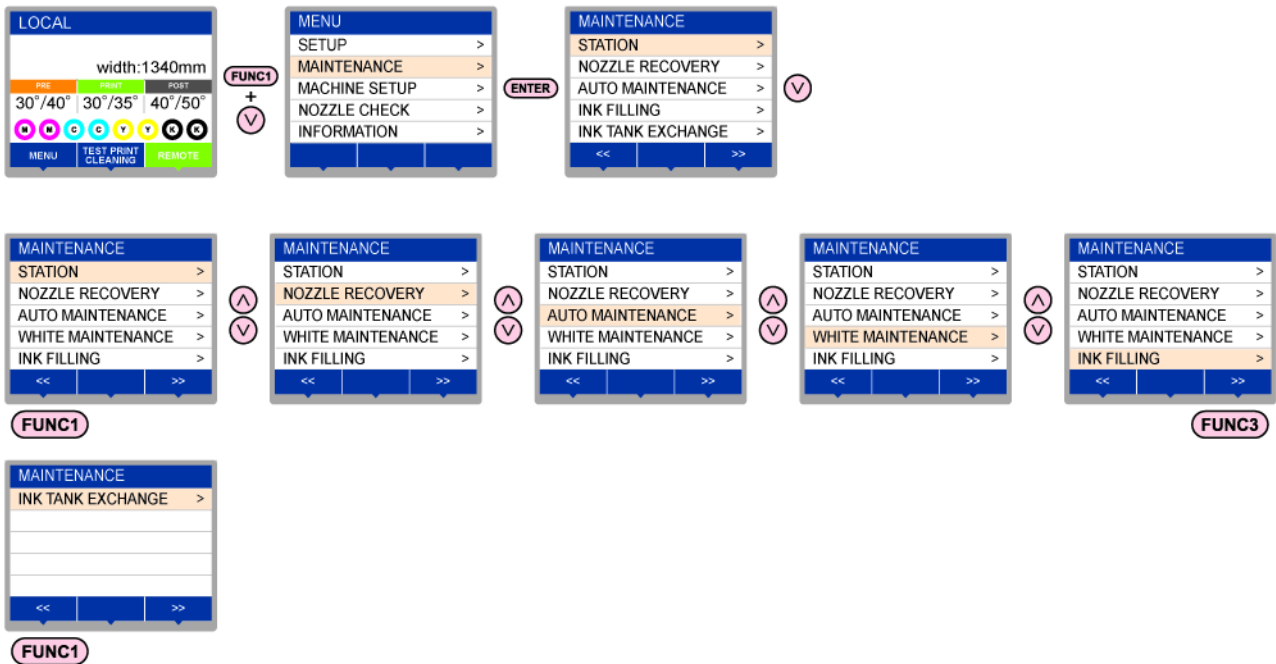

◆ Screen transition when **FUNC2** key is pressed

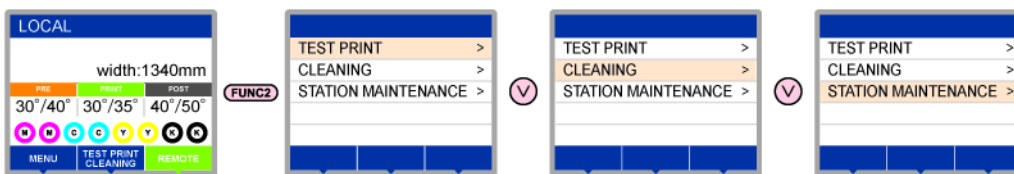

MAINTENANCE MENUS at-a-glance

Item	Set value	Meaning	
STATION MAINTENANCE	For carrying out maintenance on the carriage and station periphery.		
	CARRIAGE OUT (☞ P.5-8)	_____	Moves the carriage out, for carrying out cleaning of the cap periphery, head, wipers, etc.
	NOZZLE WASH (☞ P.5-9)	1 to 99min	Soaks the nozzle surfaces in maintenance cleaning fluid, for carrying out recovery from nozzle clogging or bent.
	DISWAY WASH (☞ P.5-10)	_____	Executes washing of the suction pump tubes.
	CUSTODY WASH (☞ P.5-10)	1 to 99min	Carried out when the machine is going to be out of use for an extended period. Washes the nozzles and tubes beforehand, to keep the machine in fine condition.
	WIPER EXCHANGE (☞ P.5-17)		Used when replacing the wiper. If the wiper is replaced, the number of times the wiper was used that is managed in this machine is reset.
	MAINT.WASH		Fill the cleaning solution to the cleaning path to prevent ink from coagulating in the cleaning path.
NOZZLE RECOVERY (☞ P.5-13)	For printing using another nozzle, if nozzle wash and so forth fail to effect recovery from nozzle clogging, etc.		
	PRINT		Prints a pattern, to identify the nozzle that is clogged.
	ENTRY		Registers the faulty nozzle identified by "PRINT".
	RESET		Resets a registered faulty nozzle.
AUTO MAINTENANCE (☞ P.5-15)	For having the various maintenance functions executed automatically. Set the execution interval for each maintenance function.		
	REFRESH	The set value will differ according to the ink type being used.	For setting the activation interval for refresh.
	PUMP TUBE & NOZZLE WASH		Set the operation interval for cleaning the pump tube and the head nozzle, and set the leaving time for cleaning the head nozzle.
	CLEANING		For setting the activation interval for head cleaning.
	CLEANING TYPE	NORMAL/SOFT/HARD	For setting the type of head cleaning.
WHITE/SILVER MAINT. (☞ P.5-17)	Executes the white and silver ink maintenance.		
INK FILLING (☞ P.5-16)	Supplies ink to correct nozzle clogging.		
INK TANK EXCHANGE (☞ P.5-19)	Resets or corrects the used count for the waste ink tank.		

Daily care other than the maintenance menu

Item	Meaning	
Ink Maintenance(☞ P.5-17)	Executes the ink maintenance.	
Replacing consumables (☞ P.5-17)	Replacing the wiper(☞ P.5-17)	Replace the wiper.
	Replacing and Adjusting the Cutter Blade(☞ P.5-20)	Replace and adjust the blade of the cutter.

Maintaining the Capping Station

Maintain the ink cap, wiper, etc. located in the capping station. (SATION MAINT.)

- Important!**
- To keep the nozzle status normal, perform wiper cleaning frequently.

The ink cap and wiper function as follows.

- Wiper** : It wipes off ink sticking to the head nozzles.
- Ink cap** : It prevents the head nozzles from clogging due to dryness.

As the machine is used repeatedly, the wiper and ink cap gradually become dirty with ink, dust, etc.

If nozzle missing cannot be corrected even after head cleaning (P.2-20) has been performed, use a cleaning solution kit and clean stick.

Tools required for Maintenance

- | | | |
|---|----------|------------------|
| • Cleaning solution MS2/ES3/HS kit 200 (SPC-0369) | | |
| • Clean stick (SPC-0527) | • Gloves | • Safety glasses |



- Be sure to wear the supplied safety glasses and gloves when maintaining the capping station. Otherwise, you may get ink in your eyes.
- Do not move the carriage out of the capping station by hand. When it is desirable to move the carriage, press the [FUNK1] key to execute the carriage-out. (P.5-8 Steps 1 to 2)

Cleaning the Wiper and Cap

It is recommended that the wiper and cap be cleaned frequently in order to maintain the high image quality of the machine and keep the machine itself in good working order.

- Important!**
- Replace the wiper with a new one when it is extremely dirty or bent. (P.5-17)
 - When cleaning the wiper, be careful that lint from the clean stick does not get left on the wiper. Remaining lint may cause image quality to deteriorate.

1 Press the **[FUNC1] (MENU)** **[ENTER]** key in LOCAL.

- MAINTENANCE MENU will be displayed.

2 Press the **[ENTER]** key twice.

- The carriage moves onto the platen.

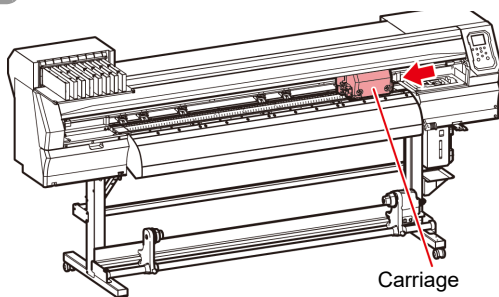

3 Remove the wiper.

- Pull out the wiper by holding the projections at its both ends.

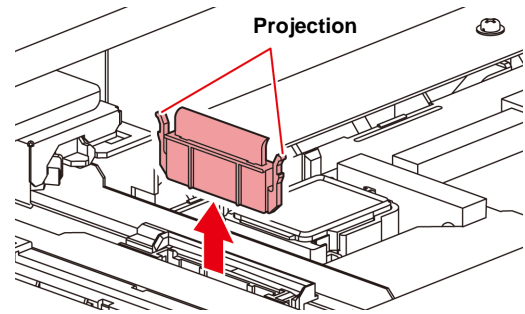

4 Clean the wiper and bracket.

- Wipe off the ink sticking to the wiper and bracket with a clean stick dipped in cleaning solution for maintenance. Wipe off so that cleaning solution for maintenance will not remain.

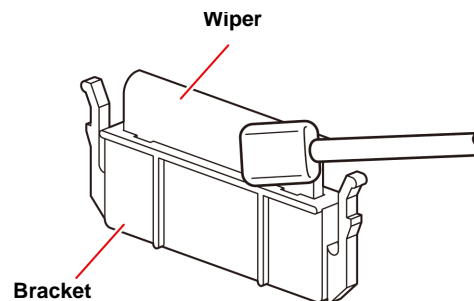

5 Clean the wiper slider.

- Wipe off the ink sticking to the wiper slider with a clean stick dipped in cleaning solution for maintenance. Wipe off so that cleaning solution for maintenance will not remain.

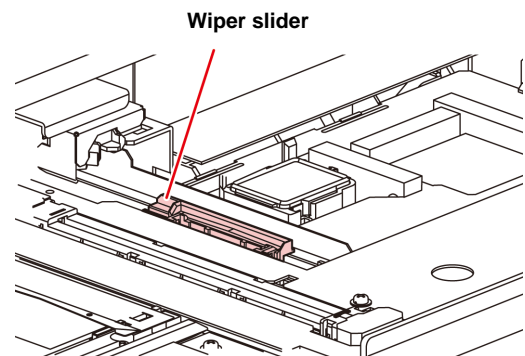

6 Set the wiper at the original position.

- Insert the wiper by holding the projections at its both ends.

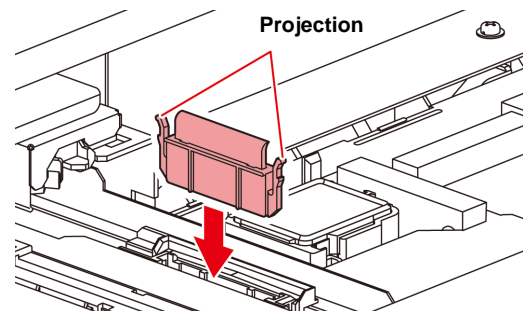

7 Clean the cap rubber.

- Wipe off the ink sticking to the cap rubber with a clean stick dipped in maintenance solution for maintenance.
- Wipe off so that maintenance solution for maintenance will not remain.

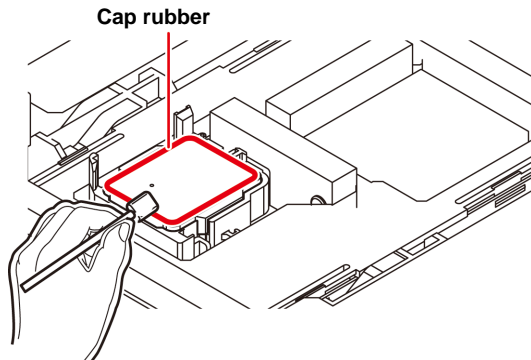
**8 Press the **ENTER** key after the cleaning.****9 Close the front cover then press the **ENTER** key.**

- After its initial operation, the machine returns to step1.

Washing the Head Nozzle**1 Press the **FUNC1** (**MENU**) **ENTER** key in LOCAL.**

- MAINTENANCE MENU will be displayed.

2 Press **▲ **▼** to select the "STATION", and press the **ENTER** key.****3 Press **▲** **▼** to select "NOZZLE WASH", and press the **ENTER** key.**

- The carriage will move onto the platen.

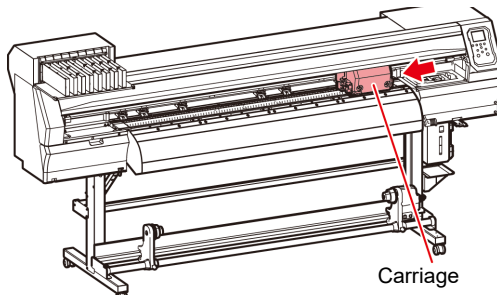
**4 Clean the wiper and the bracket, and press the **ENTER** key.**

- (1) Open the right maintenance cover then pull out it by holding projections at both ends of the wiper.
- (2) Clean the wiper and bracket with a clean stick dipped in maintenance washing liquid for maintenance. (SPC-0369)
 - Wipe off so that maintenance washing liquid for maintenance will not remain.

- (3) Insert it in the original position by holding the projections at both ends of the wiper.

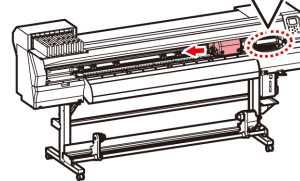
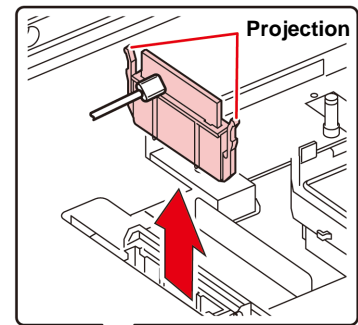
**5 Clean the cap rubber, and press the **ENTER** key.**

- Wipe off the ink sticking to the cap rubber with a clean stick dipped in maintenance washing liquid for maintenance.
- Wipe off so that maintenance washing liquid for maintenance will not remain.
- At this time, the discharge passage is cleaned automatically.

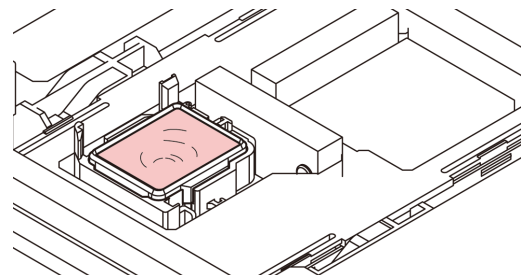
6 Fill up the cap with cleaning solution for maintenance.**7 Close the front cover, and press the **ENTER** key.****8 Press **▲** **▼** to set the time for the maintenance washing liquid to be left as it is, and press the **ENTER** key.**

- **Set value** : 1 to 99 minutes (Unit: minute)
- The maintenance washing liquid filled in the cap is absorbed.
- "Please Wait" will be displayed in the display until the time you set has elapsed.

Important!

- When nozzle missing is not cleared even after this washing is carried out several times, contact the distributor in your region or our service office.

Washing the Ink Discharge Passage

Wash the ink discharge passage regularly (about once a week) to prevent the head nozzles from clogging due to ink coagulation inside the passage.

Important!

- Before washing the ink discharge passage, make sure that the maintenance washing liquid is set. If the maintenance washing liquid is not set, washing operation will not be conducted and the passage could be clogged.

1 Press the **FUNC1 (MENU)** **ENTER** key in LOCAL.

- MAINTENANCE MENU will be displayed.

2 Press to select the “STATION”, and press the **ENTER** key.

3 Press to select “DISWAY WASH”, and press the **ENTER** key.

- The carriage will move onto the platen.
- Dry suction operation is performed repeatedly until the washing work is completed.

4 Press the **ENTER** key.

- Dry suction operation is performed repeatedly until the washing work is completed.

5 Fill up the cap with cleaning solution for maintenance.

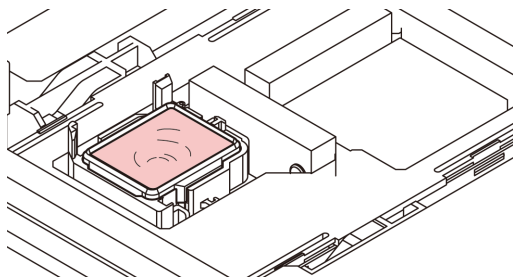

- If the cleaning solution cartridge is not usable, suck maintenance solution into a dropper and fill up the cap with it. Fill up the cap with maintenance solution on the verge of overflow from the cap.

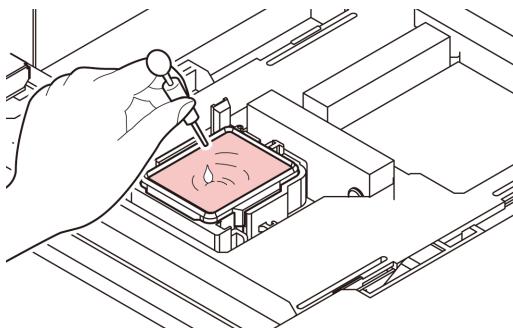

6 Press the **ENTER** key.

When the Machine Is Not Used for a Long Time

When the machine is not going to be used for a week or more, use the cleaning function for custody to clean the head nozzles and ink discharge passage. After this, keep the machine in custody.

Important!

- Use the machine with always turning “ON” the main power. The function preventing nozzle clogging operates automatically to protect the head of the nozzle.
- The head nozzle may result in nozzle clogging if the main power switch is left OFF for a long time.

Check the items on the right beforehand.

Is [NEAR END] or [INK END] displayed?

- The cleaning solution or ink is absorbed when the nozzles are washed. At this time, if the state of “no ink” or “almost no ink” is detected, the nozzle washing operation cannot start.
- Replace the cartridge with another from which the state of “almost no ink” or “no ink” is not detected.



- When the warning messages “Check waste ink” are indicated, check the waste ink tank, and operate it, referring to P.5-18 “If a Waste Ink Tank Confirmation Message Appears” according to the situation.

1 Press the **FUNC1 (MENU)** **ENTER** key in LOCAL.

- MAINTENANCE MENU will be displayed.

2 Press to select the “STATION”, and press the **ENTER** key.

3 Press to select “CUSTODY WASH”, and press the **ENTER** key.

- The carriage will move onto the platen.

Important!

- Until wiper/ bracket cleaning is completed, “COMPLETED” is displayed on the screen. After the work up to the step 3 is completed, press the [ENTER] key. If you press the [ENTER] key before cleaning is completed, the machine moves to the next washing procedure.

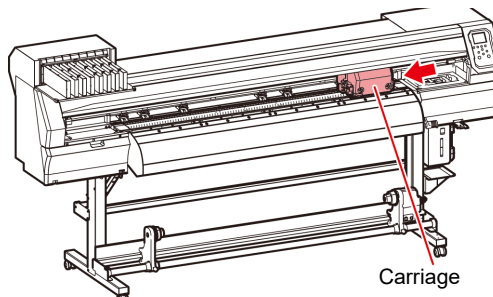

Carriage

4 Clean the wiper and the bracket.

- (1) Open the front cover then pull out it by holding projections at both ends of the wiper.
- (2) Clean the wiper and bracket with a clean stick dipped in cleaning solution for maintenance. (SPC-0369) Wipe off so that cleaning solution for maintenance will not remain.
- (3) Insert it in the original position by holding the projections at both ends of the wiper.

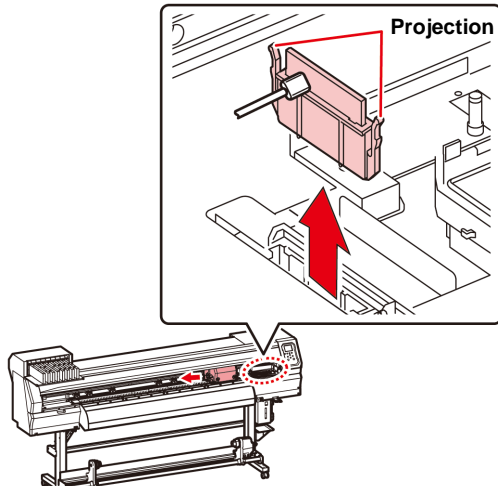
**5 Press the **ENTER** key.**

- Important!**
- Until wiper cleaning is completed, [COMPLETED (NEXT): ENT] is displayed on the screen. After the work up to the step 5 is completed, press the [ENTER] key. If you press the [ENTER] key before cleaning is completed, the machine moves to the next washing procedure.

6 Clean the cap rubber.

- Wipe off the ink sticking to the cap rubber with a clean stick dipped in maintenance solution for maintenance.
- Wipe off so that maintenance solution for maintenance will not remain.
- At this time, the discharge passage is cleaned automatically.

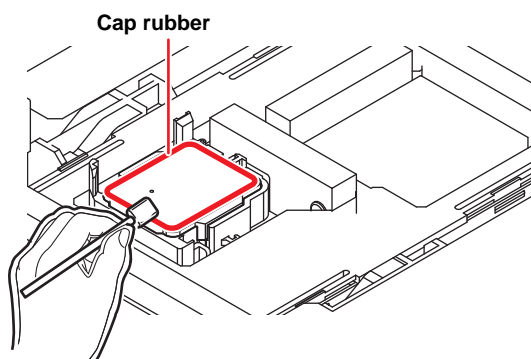
**7 Press the **ENTER** key.**

- Important!**
- Until washing liquid is filled, [COMPLETED (NEXT): ENT] is displayed on the screen. After the work up to the Step 8 is completed and you close the front cover, press the [ENTER] key. If you press the [ENTER] key before washing liquid is filled, the carriage returns to the original position.

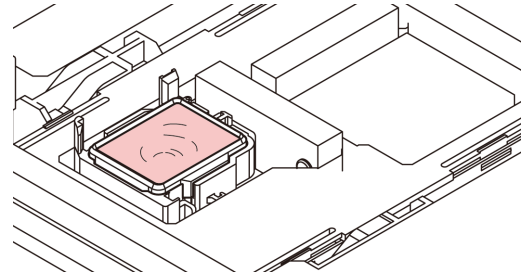
8 Fill up the cap with cleaning solution for maintenance.

- If the cleaning solution cartridge is not usable, suck maintenance solution into a dropper and fill up the cap with it. Fill up the cap with maintenance solution on the verge of overflow from the cap.

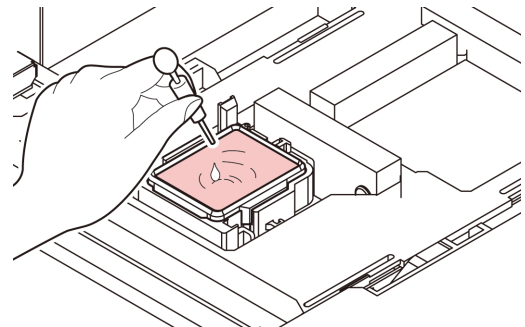
**9 Press the **ENTER** key.****10 Press **▲** **▼** to set the time for the cleaning solution to be left as it is.**

- Set Value: 1 to 99 min (by the unit of 1 min)

11 Press the **ENTER key.**

- The nozzles are washed.
- When the nozzles have been completely washed, the head moves to the maintenance position.

12 Open the front cover.

13 Fill up the cap with cleaning solution for maintenance.

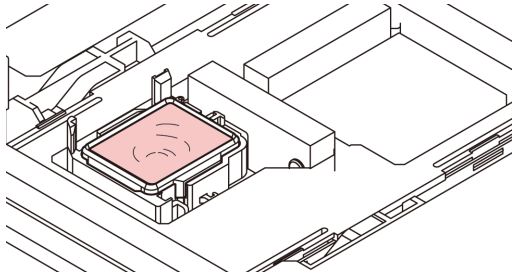

- If the cleaning solution cartridge is not usable, suck maintenance solution into a dropper and fill up the cap with it. Fill up the cap with maintenance solution on the verge of overflow from the cap.

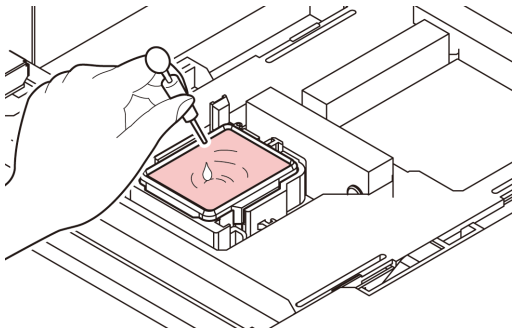

14 Close the front cover and press the **ENTER** key.

- After its initial operation, the machine returns to step2.

Cleaning the Ink Head and the Area around It

Because the ink head employs a very precise mechanism, due care needs to be taken when it is cleaned.

Using a clean stick, etc., rub off gelatinous ink or dust that may stick to the slider and the area around the ink head. In doing so, never rub the nozzles of the head.

Tools required for cleaning

- | | |
|--------------------------|----------|
| • Clean stick (SPC-0527) | • Gloves |
| • Safety glasses | |



- Be sure to wear the attached safety glasses and gloves when cleaning the area around the ink head. Otherwise, you may get ink in your eyes.
- The ink contains organic solvent. If you get the ink on your skin or in your eyes, wash it away with plenty of water immediately.

1 Press the **FUNC1** (MENU) **ENTER** key in LOCAL.

- MAINTENANCE MENU will be displayed.

2 Press the **ENTER** key twice to select the "CARRIAGE OUT".

3 Press to select "HEAD MAINTENANCE", and press the **ENTER** key.

- The carriage will move to the left end of this machine.

4 Open the maintenance cover.

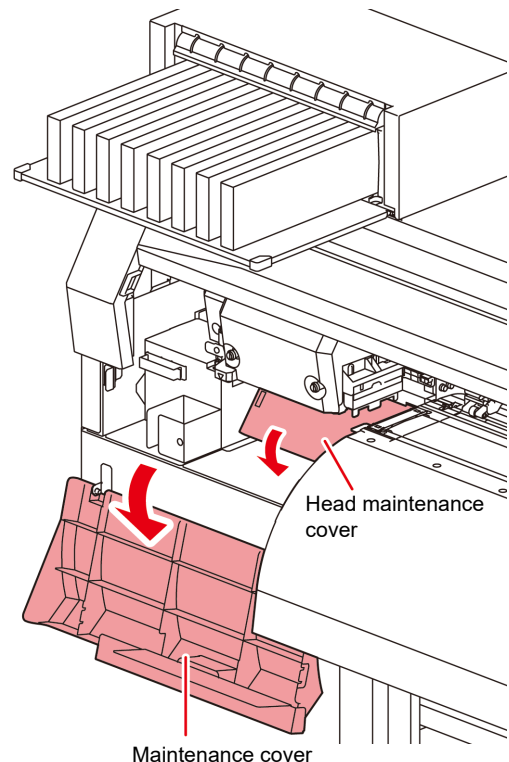

- 5** Use a clean stick soaked in maintenance cleaning fluid to wipe ink off the head surface or other surfaces.

- Never rub the nozzles.

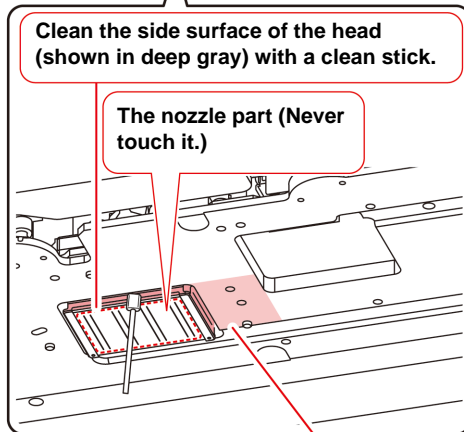
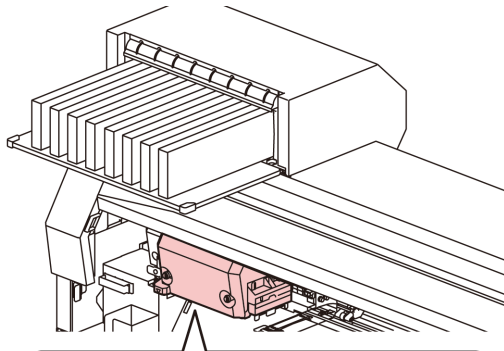

Clean with a clean stick or a waste cloth.

- 6** Press the **ENTER** key after the cleaning.

- 7** Close the maintenance cover, and press the **ENTER** key.

- After its initial operation, the machine returns to LOCAL.

Nozzle Recovery Function

NOZZLE RECOVERY: When nozzles missing can not be improved at specific points, other good nozzles can be used as alternatives for printing.

- 1** Press the **FUNC1** (**MENU**) \rightarrow \downarrow \rightarrow **ENTER** key in LOCAL.

- MAINTENANCE MENU will be displayed.

- 2** Press \uparrow \downarrow to select “**NOZZLE RECOVERY**”, and press the **ENTER** key.

- 3** Press the **ENTER** key twice.

- Printing of the nozzle pattern will start.
- Select “ENTRY” then “Move to select of the Nozzle line (Step 4) without drawing a pattern”

Overhead view

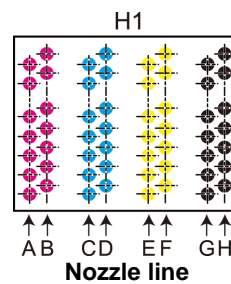

Nozzle pattern

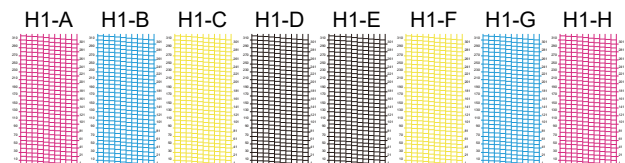

Important!

- For 6-color ink sets, the nozzle patterns “H1-B” and “H1-D” are not printed.
- When using leaf media, set a media of more than A3 size put horizontally. If a media with narrow width is set, printing will only be conducted to midway.

- 4** Select the Nozzle line that needs **NOZZLE RECOVERY** by pressing \uparrow \downarrow , and press **ENTER** key.

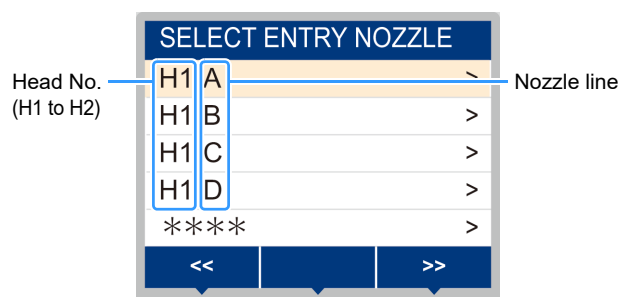

5 Register the Nozzle number that needs NOZZLE RECOVERY and press [ENTER] key.

- (1) Select the registration number from 1 to 10 by pressing [▲][▼] key and press the [ENTER] key.
- (2) Register the nozzle number that needs recovery by pressing [▲][▼] key and press the [ENTER] key.

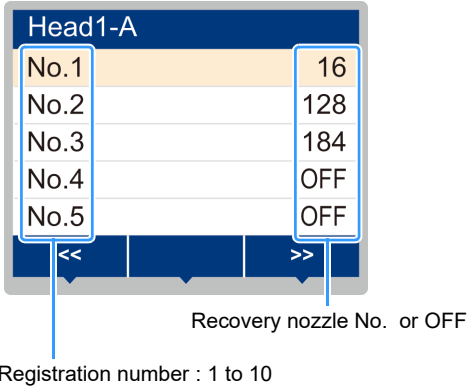

Example of nozzle to be recovered

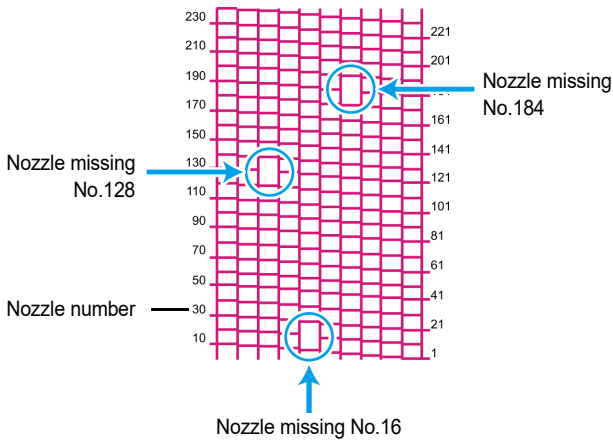

Registration number	Recovery Nozzle No.	State
1	16	Target for nozzle recovery
2	128	Target for nozzle recovery
3	184	Target for nozzle recovery
4	OFF	No registration
5	OFF	No registration

6 Press the [END/POWER] key several times to end the setting.

- Important!**
- Up to 10 nozzles can be registered per 1 nozzle line.
 - Even if you use this function, time required for drawing does not change.
 - When printing has been done with the lowest path, nozzle recovery is not reflected. Moreover, depending on the conditions, there are cases where only 20 to 120 nozzles are enabled at both head ends (front and rear). Perform test printing to confirm.



- When you use white ink, print on the clear film to check.

Reset the set value

- 1** Press the [FUNC1] (MENU) → [▼] → [ENTER] key in LOCAL.
 - MAINTENANCE MENU will be displayed.
- 2** Press [▲][▼] to select “NOZZLE RECOVERY”, and press the [ENTER] key.
- 3** Press [▲][▼] to select “RESET”, and press the [ENTER] key.
- 4** Press [▲][▼] and [FUNC1] (PAGE>) [FUNC3] (<<) to select the Nozzle line that need reset, and press the [ENTER] key.
 - A reset confirmation message will be displayed.
- 5** Press the [ENTER] key.
- 6** Press the [END/POWER] key several times to end the setting.

Automatic Maintenance Function

To use this machine comfortably, you can set various maintenances to be performed automatically.

Here, set performing intervals of various automatic maintenances.

You can prevent troubles such as ink clogging by performing automatic maintenance periodically (automatic maintenance function).

For the auto maintenance functions, the following items can be set:

- Important!**
- When you perform maintenance manually, after manual maintenance is completed and when time set with the automatic maintenance function has passed, maintenance starts automatically.

Function name	Descriptions
REFRESH	The interval between each refreshing operation is set.
PUMP TUBE & NOZZLE WASH	Set the operation interval for cleaning the pump tube and the head nozzle, and set the leaving time for cleaning the head nozzle. After setting the leaving time, the nozzle surface is immersed in the cleaning solution and then washed.
CLEANING (Interval)	The interval between each cleaning operation is set.
CLEANING (Type)	The cleaning type is set.

- Important!**
- If the "Check waste ink" warning message is displayed, the operation set in the auto maintenance function is not carried out. Perform the operations of P.5-18 "Replace the waste ink tank with another" if required.
 - When the power switch on the front of the machine is turned off, check the waste ink tank.

Setting the Refreshing Intervals

The interval between each operation of ejecting a small amount of ink from the nozzles to prevent nozzle clogging is set.

- Press the **FUNC1 (MENU)** key \rightarrow **ENTER** key in LOCAL.
 - MAINTENANCE MENU will be displayed.
- Press \uparrow \downarrow to select "AUTO MAINTENANCE", and press the **ENTER** key.
- Press \uparrow \downarrow to select the "REFRESH", and press the **ENTER** key.
- Press \uparrow \downarrow to set the refreshing interval, and press the **ENTER** key.
 - Set value** : The set value will differ according to the ink type being used.
- Press the **END/POWER** key several times to end the setting.

Setting the Pump Tube & Nozzle Wash Intervals

To prevent ink clogging due to coagulation of ink on the ink discharge path and the head nozzle surface, set the interval for cleaning the ink discharge path and the head nozzle surface. When cleaning the head nozzle, also set the leaving time (Time to immerse the nozzle surface in the cleaning solution filled in the cap).

- Important!**
- When using the auto maintenance function, make sure that the cleaning solution for maintenance is set. If the cleaning solution for maintenance is not set, the pump tube and nozzle cleaning operations will not be regularly performed, and the pump tube and the head nozzle may be clogged.
 - Hard cleaning is performed at the end of nozzle cleaning. (Ink consumption: approx. 33 ml / 1 time)
Therefore, when cleaning cannot be performed (for example, ink shortage), nozzle cleaning is not performed and only pump tube cleaning is performed.
Please be careful.

- Press the **FUNC1 (MENU)** key \rightarrow **ENTER** key in local mode.
 - MAINTENANCE MENU will be displayed.
- Press \uparrow \downarrow to select "AUTO MAINTENANCE", and press the **ENTER** key.
- Press \uparrow \downarrow to select "PUMP TUBE & NOZZLE WASH", and press the **ENTER** key.
- Press \uparrow \downarrow to select "INTERVAL", and press the **ENTER** key.
- Press \uparrow \downarrow to set the pump tube and nozzle washing interval, and press the **ENTER** key.
 - Set value**: 24 to 48 hours (h)
The default setting differs depending on the ink type used.
- Press \uparrow \downarrow to select "LEAVING TIME", and press the **ENTER** key.
- Press \uparrow \downarrow to set the leaving time to immerse the nozzle surface in the cleaning solution, and press the **ENTER** key.
 - Set value**: OFF, 1 to 99 minutes (1 minute unit)
 - If the leaving time is set to OFF, nozzle cleaning will not be performed. Only pump tube cleaning is performed.
- Important!**
 - By default, the leaving time is set to "OFF". Therefore, nozzle cleaning is not performed. If you want to execute nozzle cleaning, set the leaving time. **Recommended value is 1 minute.**
- Press the **END/POWER** key several times to end the setting.

Setting the Cleaning Intervals and Type

The cleaning type and the interval between each cleaning operation are set.

- 1 Press the **FUNC1 (MENU)**  **ENTER** key in LOCAL.
 - MAINTENANCE MENU will be displayed.
- 2 Press **▲▼** to select “AUTO MAINTENANCE”, and press the **ENTER** key.
- 3 Press the **▼** several times to select “Interval” or “Type”, and press the **ENTER** key.
- 4 Press **▲▼** to select a set value, and press the **ENTER** key.
 - **Set value** : The set value will differ according to the ink type being used.
 - **Set value of type** : SOFT/ NORMAL/ HARD
- 5 Press the **END/POWER** key several times to end the setting.

When 600ml cartridge is used

- **Even when [Ink Level] is displayed, enough ink for head cleaning may remain in the ink pack.**

When [Ink Level] appears, see P.3-15 “When [Ink Level low] is displayed” and enter the current weight of the 600ml cartridge.
- **When the remaining ink is not enough for head cleaning**

When the remaining ink is not enough for head cleaning, an error message “Error” shown on the step 3. Replace with a new ink pack, and then perform head cleaning again.

Fill up Ink

Supplies ink to correct nozzle clogging.

- 1 Press the **FUNC1 (MENU)**  **ENTER** key in LOCAL.
 - MAINTENANCE MENU will be displayed.
- 2 Press **▲▼** to select “FILL UP INK”, and press the **ENTER** key.
- 3 Press **▲▼** to select the filling type.
 - **Standard** : When nozzle drop outs or nozzle missing parts that cannot be recovered by soft filling occurs (FW version 4.3 or later)
 - **Soft** : Use this in cases where head cleaning will not achieve recovery, such as when multiple clogged nozzles occur or nozzle cluster dropout occurs.
 - **Normal** : Use this if nozzle cluster dropout occurs in initial ink filling.
 - **Hard** : Use this in cases where the dumper has become empty, such as in dumper replacement.
- 4 Press the **ENTER** key.
 - If you selected “Standard” or “Soft” in step 3, a Select Fill Up Color screen will be displayed. If you selected “Normal” or “Hard”, go to step 6.
- 5 Press **▲▼** to select the filling color, and press the **ENTER** key.
- 6 Press the **ENTER** key.
 - Ink is supplied automatically.
- 7 Press the **END/POWER** key several times to end the setting.

Ink Maintenance

Shake the ink periodically. If you do not shake the ink periodically, the print quality may deteriorate rapidly. Shake about once a month. (P.1-9)

Shake the 2L ink pack in the same way. However, the MBIS (optional) must be attached and removed no more than 10 times in total.

Please use our recommended ink cartridge.

White Ink Maintenance

White ink precipitates easier than other inks.

If not printing more than two weeks, white ink may precipitate in the ink cartridge or inside of this machine.

When an ink precipitates, the nozzle may be clogged and it can not draw normally.

Make sure to perform periodical maintenance to avoid precipitation and to keep white ink in good condition.

(1) Remove the ink cartridge and shake gently in the following cases. (P.1-9)

- When 24 hours have passed with the power supply is ON.
- When the power supply is ON, the warning message "SHAKE WHITE INK CARTRIDGES" is displayed.

(2) Perform the maintenance below before working once a week.

1 Press the **FUNC1 (MENU)** → **ENTER** key in LOCAL.

- MAINTENANCE MENU will be displayed.

2 Press **FUNC1 (<<)**, and press the **ENTER** key.

3 Press **▲ ▼** to select "WHITE MAINT", and press the **ENTER** key.

4 Press the **ENTER** key.

5 Press the **ENTER** key.

- The automatic discharging operation and the filling operation are performed, then, cleaning is performed.

6 Press the **END/POWER** key several times to end the setting.

Replacing consumables

Replacing the wiper

The wiper is consumable. When the display indicates the warning message "Replace a WIPER" it is necessary to check and replace the wiper, immediately replace the wiper with a new one.

Also, wipe ink sticking to the lower surface of the slider off.

Important!

- When the warning message for replacing wiper is shown, confirm whether there is no damage and fuzz at the top edge of the wiper film. If there is no damage on the top edge of the wiper film, it is possible to use the wiper continuously without replacing it.
- A cleaning wiper is an option. Buy one through the dealer in your region or at our service office.

1 Press the **FUNC1 (MENU)** → **ENTER** key in LOCAL.

- MAINTENANCE MENU will be displayed.

2 Press **▲ ▼** to select the "STATION", and press the **ENTER** key.

3 Press **▲ ▼** to select "WIPER EXCHANGE", and press the **ENTER** key.

- The number of times the wiper was used will be reset.

4 Press the **ENTER** key.

- The carriage will move onto the platen.

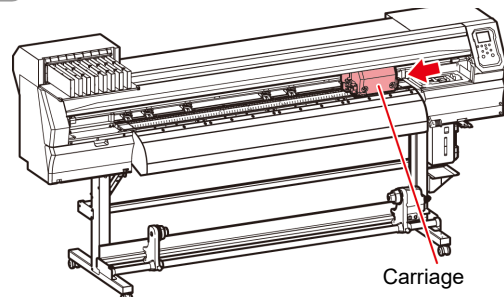

- The number of times the wiper was used will be reset.

5 Remove the wiper.

- Pull out the wiper by holding the projections at its both ends.

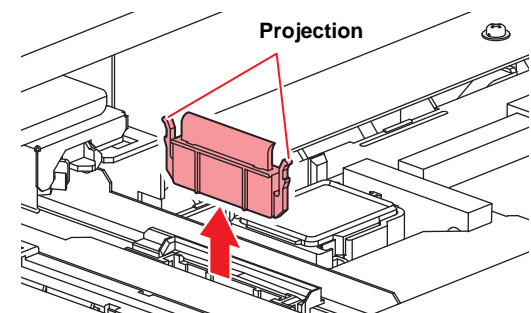

6 Insert a new wiper.

- Insert the wiper by holding the projections at its both ends.

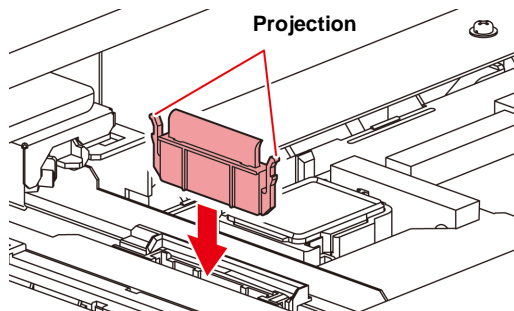

7 Press the [ENTER] key.

- After its initial operation, the machine returns to LOCAL.

If a Waste Ink Tank Confirmation Message Appears

Ink used in head cleaning, etc. is stored in the waste ink tank on the lower right side of the machine. This machine counts the accumulated amount of discharged ink. When that reaches a specified amount, the machine displays a confirmation message. (When this message is displayed, consider the replacement of the waste ink tank.)



- The message is displayed when it reaches 80% (1.6L) of the 2L tank.

Confirmation Message in LOCAL

1 The warning message “Check waste ink” is displayed.

2 Check the state of the waste ink tank

- When it is different from the actual amount, press [▲][▼] and correct.
- When you correct (80%), press the [ENTER] key to return to LOCAL.
- When you replace (disposal) and clear the count, perform the procedures in “Replace the waste ink tank with another”. (P.5-18)



- Check the waste ink level in the waste ink tank frequently. Continuing to use the product without disposing of the waste ink may result in waste ink overflowing from the waste ink tank.

Replace the waste ink tank with another

1 The warning message “Check waste ink” is displayed.

2 Press the [FUNC1] (MENU) [▼] [ENTER] key in LOCAL.

- MAINTENANCE MENU will be displayed.

3 Press [▲][▼] to select “INK TANK EXCHANGE”, and press the [ENTER] key.

4 If the amount of waste ink needs to be adjusted, press the [ENTER] key.

- Compare the amount of waste ink shown on the display and the amount you visually confirmed. If there is no major problem with the value shown on the display, instead of the [ENTER] key, press the [END] key and proceed to Step 6.

5 Press [▲][▼] to adjust the level, and press the [ENTER] key.

6 Pull the waste ink tank stopper to open to the front.

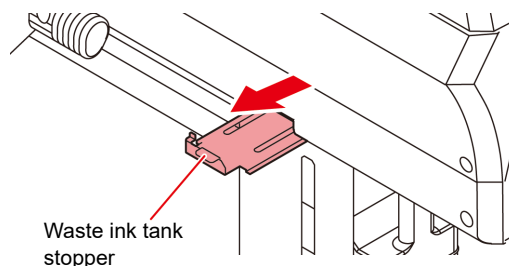

7 Pull it frontward to remove by holding the waste ink tank handle.

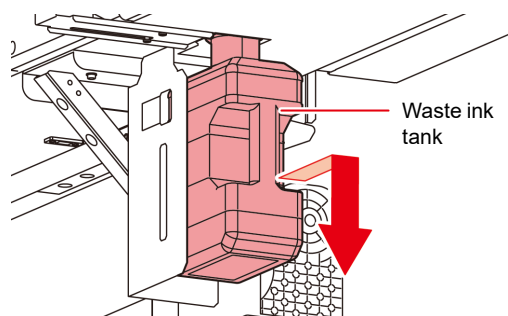

- Put a cap on the waste ink tank removed.

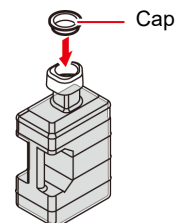

8

Replace the waste ink tank.

- (1) Prepare a new waste ink tank (SPA-0246).
- (2) Insert the waste ink tank by holding a handle of the tank.

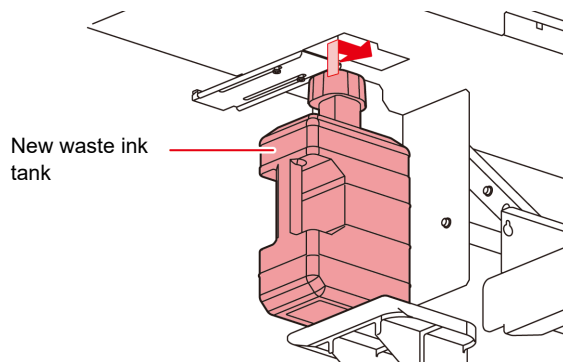

- Waste ink is equivalent to waste oil of industrial waste. Request an industrial waste disposal company for disposal of waste ink.

9

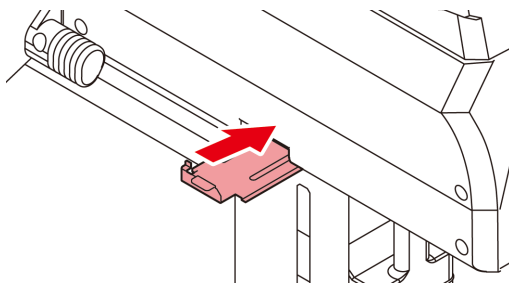
Close the waste ink tank stopper.

10

Press the **ENTER key.**

- The ink discharging amount that is controlled by the machine is reset and the message is cancelled.

Replacing the waste ink tank before the waste ink tank confirmation message is displayed

if you replace the waste ink tank before the waste ink tank confirmation message is displayed (before the 2L tank is 80% (1.6L) full), set the waste ink information to 0% in the Information menu.

1

Perform steps 6 through 9 in "Replace the waste ink tank with another" (P.5-18) to empty the waste ink tank.

2

Press the **FUNC1 (MENU)** → **ENTER** key in LOCAL.

- MAINTENANCE MENU will be displayed.

3

Press **ENTER** to select "INK TANK EXCHANGE", and press the **ENTER** key.

4

Waste ink tank information is displayed.

5

Press **ENTER** to adjust the level, and press the **ENTER** key.

- The reset screen for the waste ink tank amount will be displayed.

6

Press the **ENTER** key.

- The waste ink tank amount that is managed in this machine will be reset.

Replacing the Cutter Blade

The media cutter blade is consumable. When the cutter blade gets dull, replace it with a new one (SPA-0107).



- The blade is sharp. Be careful not to hurt yourself or anyone else.
- Store the cutter blade in a place that is out of the reach of children. In addition, dispose of used cutter blades according to regional laws and regulations.



- When replacing the cutter blade, it is recommended to place a sheet of paper under the cutter blade. This will help pick up the cutter blade if it drops.

1

Press the **FUNC1 (MENU)** → **ENTER** key in LOCAL.

- MAINTENANCE MENU will be displayed.

2

Press the **ENTER** key twice.

- The carriage moves onto the platen.

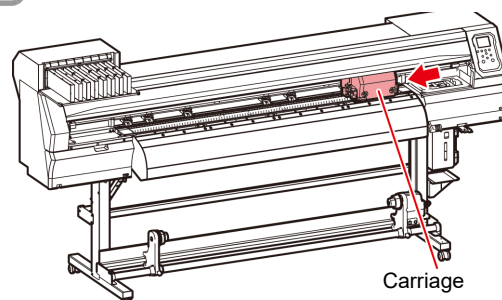

5

3 Replace the cutter unit by the carriage.

• Now the cutter unit can be moved manually. Move the cutter unit to the position where you can assure easy access, and replace the blade edge.

- (1) Loosen the screw of the cutter unit.
- (2) Remove the cutter unit.
- (3) Mount a new cutter unit.
- (4) Fasten the screw of the cutter unit to secure the cutter unit.

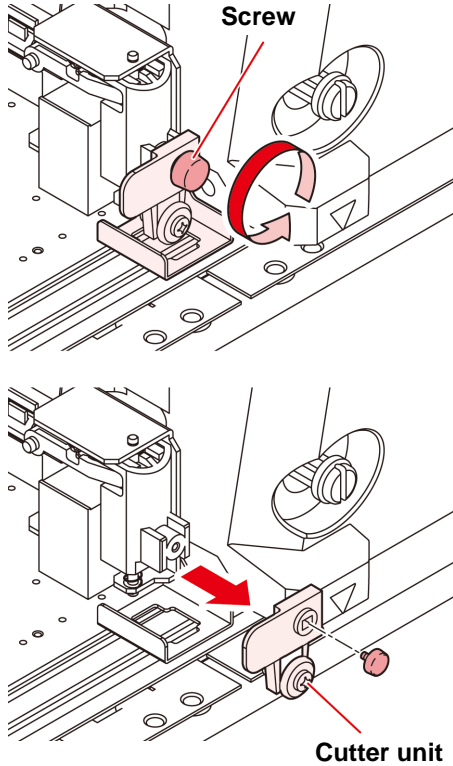

4 When replacement is finished, press the

ENTER key.

• The screen returns to LOCAL.

Replacing and Adjusting the Cutter Blade



- The cutter blade is sharp. Keep your fingers away from the cutter.
- Do not shake or swing the cutter holder; otherwise, the cutter blade may come off, which is dangerous.
- Keep the cutter out of reach of children. Dispose of the used cutter blade in compliance with the applicable regulations.

Replacing the cutter

If the cutter is chipped or blunt, replace it with a new one. (Accessory parts number: SPA-0030)

New cutter (low-pressure blade set for PVC sheets: Model SPB-0030) are available from your distributor or MIMAKI's sales office.

Name of product	Product No.	Specific ations	Remarks
Swivel Blade for PVC sheet	SPB-0001	Three blades	
Swivel Blade for small letters	SPB-0003	Three blades	
Decentering blade for rubber sheet	SPB-0005	Three blades	
Swivel Blade for reflecting sheet	SPB-0006	Two blades	
Swivel Blade for fluorescent sheet	SPB-0007	Three blades	
Swivel Blade for PVC with low-pressure	SPB-0030	Three blades	supplied one
Decentering blade for thick rubber sheet	SPB-0084	Three blades	

1 Remove the cap located at the edge by rotating it.

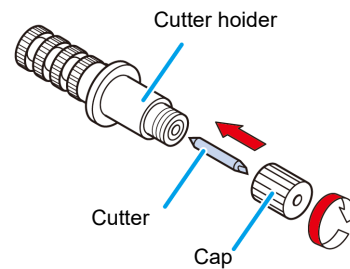

2 Replace the cutter with a new one using tweezers or the like.

Adjusting the Cutter Blade

After adjusting the blade edge, set the cut condition and perform test cut to check whether cutting is performed well.

1 Turn the adjusting knob to adjust the protruding amount of the cutter.

- arrow to protrude the cutter blade.
(0.5 mm per revolution)

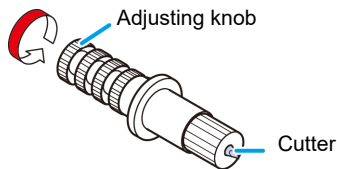

Replacing the cutter other than supplied one

1 Loosen the lock nut, and pull the adjusting knob out of the holder.

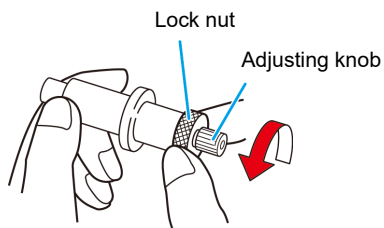

2 Insert the cutter into the adjusting knob using tweezers.

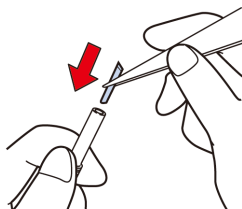

3 Tighten the lock nut.

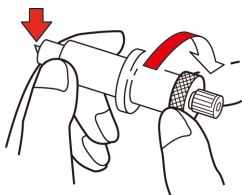

Adjusting blade edge of cutter other than supplied one

1 Loosen the lock nut.

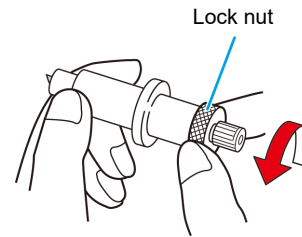

2 Turn the adjusting knob to adjust the protruding amount of the cutter blade.

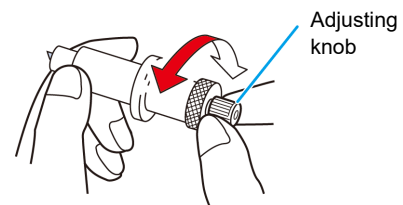

3 Tighten the lock nut so that the adjusting knob will not turn.



- The blade adjuster (Product No.: OPT-S1005) will facilitate the adjustment of the protruding amount of the blade.

Chapter 6

Troubleshooting



This chapter

describes the corrective measures to be taken for a phenomenon suspected to be trouble and the procedures to clear the error number displayed on the LCD.

Troubleshooting	6-2
Power does not turn on	6-2
The machine does not start printing	6-2
Media get jammed / media is soiled	6-2
The heater's temperature will not rise to the set level	6-3
Image quality is poor	6-3
Nozzle is clogged	6-3
Ink cartridge warning appears	6-4
When the ink leakage occurs	6-4
Warning / Error Messages	6-5
Warning messages	6-5
Error messages	6-8

Troubleshooting

Take appropriate actions as described below before taking the trouble as a failure.

If still the problem is not solved after troubleshooting, contact your local distributor, our sales office, or service center.

Power does not turn on

In most cases, this is due to improper connection of the power cable for the machine or computer. Check that the power cable is connected properly.

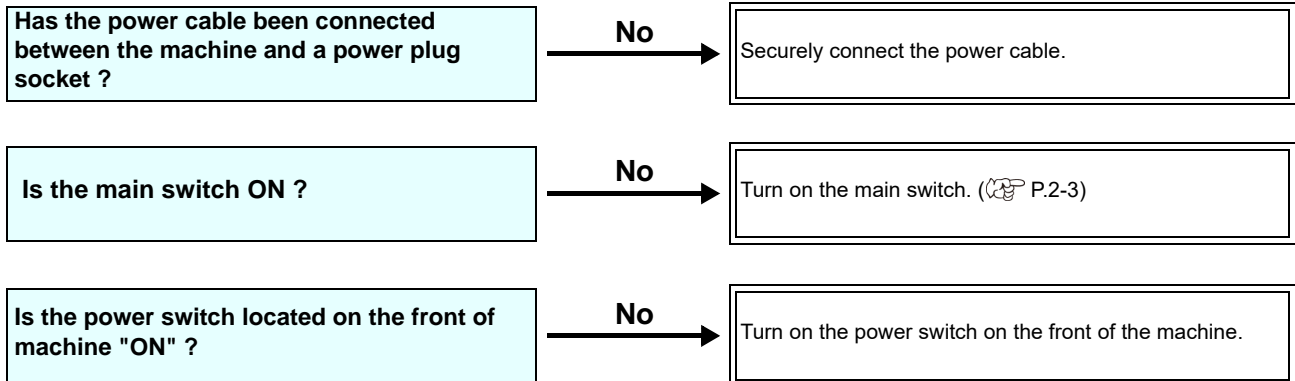

The machine does not start printing

This occurs when the data is not being transmitted to the machine properly.

It can also occur when the printing function does not work properly or the media is not set correctly.

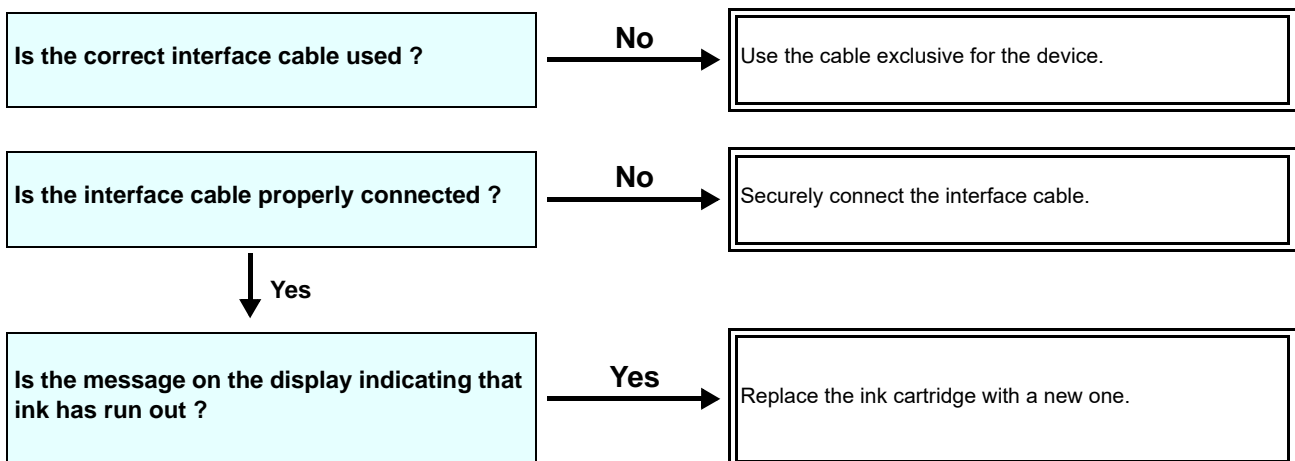

Media get jammed / media is soiled

Media jamming or stained media is considered to be due to the use of an unsuitable media or improper setting of media.

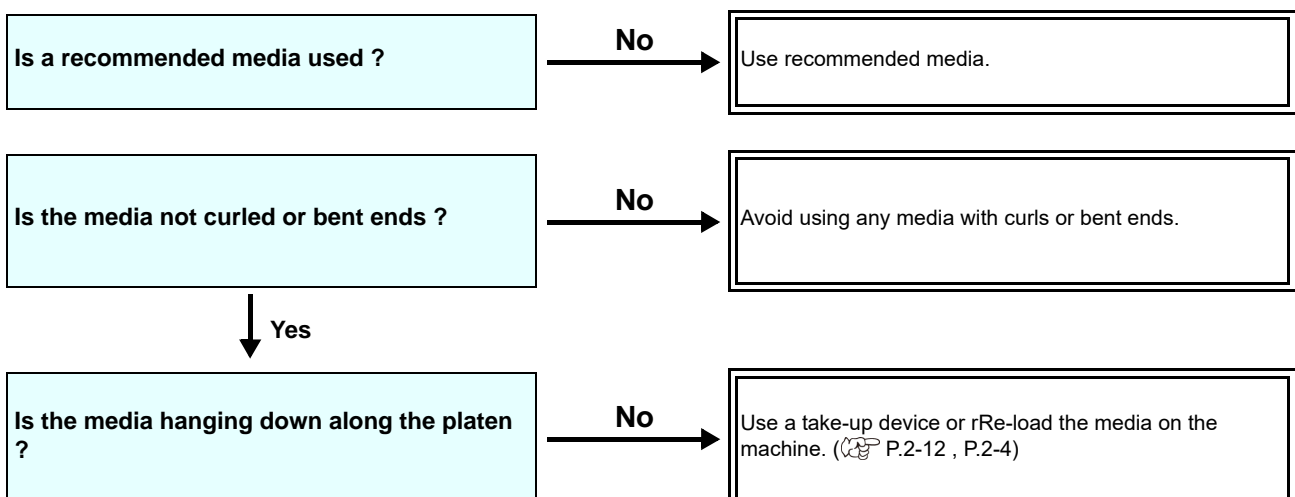

The heater's temperature will not rise to the set level

Check the basic operation.

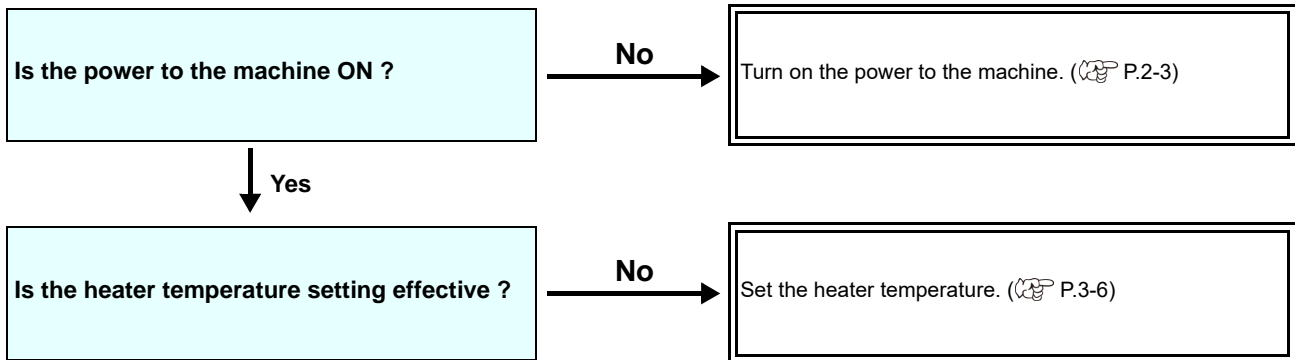

Image quality is poor

This section describes the corrective actions to be taken in case the image quality is not satisfactory.

Take remedy for particular problems with image quality. If the remedy does not work, contact your local distributor, our sales office, or service center.

Phenomenon	Measures
White lines / blur / dark stripes (in the direction of travel of the heads)	<ol style="list-style-type: none"> (1) Execute the head cleaning. (☞ P.2-20) (2) Perform maintenance of the inside of the station. (☞ P.5-8) (3) Execute the [FEED COMP.] function. (☞ P.3-5) (4) If any pieces of paper or dust is attached on the path of the heads such as media press, remove it.
Characters are double- or triple-printed in the media feed direction	<ol style="list-style-type: none"> (1) Execute the [FEED COMP.] function. (☞ P.3-5)
Disagreement in print positions between outward trip and homeward trip	<ol style="list-style-type: none"> (1) Execute the [DROP POSITION] function. (☞ P.3-6)
Ink drops falling on media during printing	<ol style="list-style-type: none"> (1) Execute the wiper cleaning. (☞ P.5-8) (2) Execute the ink cap cleaning. (☞ P.5-8) (3) Clean around the head. (☞ P.5-12) (4) Execute the head cleaning [NORMAL]. (☞ P.2-20) (5) Set the INTERVAL WIPING operation. (☞ P.3-9)

Nozzle is clogged

When nozzle clogging is not dissolved even after the head cleaning referring to P.2-20, make sure the following operations.

- Wash the head nozzle by the operations of P.5-9.
- Wash the head nozzle surface by the operations of P.5-12.
- Recovery the nozzle by the operations of P.5-13.

Ink cartridge warning appears

If an ink cartridge trouble is detected, the cartridge LED “red” is lit, and a warning message appears. None of printing, cleaning and all the other operations that use ink is available. In this case, replace the ink cartridge in question immediately.

Displaying the description of ink cartridge trouble

The contents of cartridge error are confirmable by the following operations.



- Once cartridge trouble is displayed, do not leave the ink cartridge without replacing it for a long time; otherwise, the machine will lose the nozzle clogging prevention function. If nozzles are clogged, the machine must be repaired by MIMAKI's service engineer.

1

Press the **ENTER** key in **LOCAL**.

2

Press the **ENTER** key.

When the ink leakage occurs

If the ink leakage occurs, unplug the power plug to turn off the main power switch, and contact your local distributor, our sales office, or service center.

Warning / Error Messages

If some trouble occurs, the buzzer sounds and the display shows a corresponding error message. Take an appropriate remedy for the displayed error.

Warning messages

Errors when performing operations

Message	Cause	Solution
INVAILD OPERATION :MEDIA UNDETECT	Operation cannot be performed because no media is detected.	<ul style="list-style-type: none"> Execute after media is detected.
INVAILD OPERATION :MOTOR POWER OFF	The motor is OFF after the cover was opened etc.	<ul style="list-style-type: none"> Return to LOCAL and execute the operation after completion of initialization.
INVAILD OPERATION INK ERROR	An ink error occurred.	<ul style="list-style-type: none"> Execute the operation after replacing with a new ink cartridge.
INVAILD OPERATION COVER OPEN	The front cover or the maintenance cover is opened.	<ul style="list-style-type: none"> Execute the operation after closing the cover.
INVAILD OPERATION DATA REMAIN	Data was received.	<ul style="list-style-type: none"> Execute the operation after executing data clear. (☞ P.2-22)

Message displayed in LOCAL

Message	Cause	Solution
Can't print/cartridge	Multiple ink errors (unusable ink) have occurred, making it impossible to feed ink (printing and cleaning, etc.).	Replace with a new ink cartridge.
Check waste ink	The waste ink tank count has exceeded the prescribed amount.	Check the amount of waste ink in the waste ink tank. Conduct maintenance and waste ink tank replacement, and reset the amount of waste ink.
Replace WIPER	The used count of wiper has exceeded the prescribed number.	Execute maintenance, station maintenance and wiper exchange and replace the wiper.
HEATER Temp. error Powered off	Displayed when power is forcibly turned OFF and restarted after occurrence of "ERROR 710 heater temp error".	If displaying again, contact your local distributor, our sales office, or service center.
NO MEDIA	No media is set. Or, the sensor is faulty.	Set the media. If the same error message still appears after setting the media, contact your local distributor, our sales office, or service center.
DATA REMAIN	Print data is received in LOCAL.	Shift to REMOTE and execute printing. Or, execute data clear and cancel printing.
MACHINE TEMP./H **°C	Stable printing cannot be done because temperature in the installed environment (machine) is too high.	Adjust the ambient temperature to within the specified scope (20°C to 35°C).
MACHINE TEMP./L **°C	Stable printing cannot be done because temperature in the installed environment (machine) is too low.	

Message	Cause	Solution
Shake WHITE INK - cartridges	A warning to prevent settling of the white ink cartridge is regularly displayed.	Shake the white ink cartridge to prevent the ink components from settling.
Replace the spout rubber - of ECO-CARTRIDGES	It is time to replace spout rubber of the eco-case (MBIS).	• Ink may leak from the eco-case. Replace spout rubber.
Wash liquid cartridge none	The maintenance washing liquid cartridge is not set. Wiper washing and pump tube washing cannot be executed. (Auto maintenance operation)	Set the maintenance washing liquid cartridge.
Wash liquid end	There is no remaining maintenance washing liquid. Wiper washing and pump tube washing cannot be executed. (Auto maintenance operation)	Replace with a new washing liquid cartridge.
NCU SENSOR LEVEL LOW	The NCU sensor sensitivity is falling.	Replacement of the NCU is recommended. Contact your local distributor, our sales office, or service center.
Nozzle Missing Print Stopped	Because the nozzle check found nozzles missing, printing was stopped.	Perform head cleaning (☞ P.2-20) and deal with the nozzles clogging (☞ P.6-3).
NCU FLUSH POS Nozzle check OFF	Because an NCU-related error occurred during nozzle check, printing was stopped and the nozzle check function was turned OFF.	• Take steps according to the explanation for "ERROR 655 / NCU FLUSH POS".
NCU CENTER POS Nozzle check OFF		• Take steps according to the explanation for "ERROR 654 / NCU CENTER POS".
NCU SN ADJUST Nozzle check OFF		• Take steps according to the explanation for "ERROR 656 / NCU SN ADJUST".
NCU NZK CHK (HW) Nozzle check OFF		• Take steps according to the explanation for "ERROR 652 / NCU NZK CHK (HW)".
NCU NZK CHK (MARK) Nozzle check OFF		• Take steps according to the explanation for "ERROR 653 / NCU NZK CHK (MARK)".
NCU CONNECT	The NCU unit is not connected. The nozzle check function cannot be used.	• Turn the main power off once and turn it back on after some time. If the same error message appears, contact your local distributor, our sales office, or service center.
REPLACE NCU	The NCU sensor sensitivity is too low to correctly judge nozzle missing. The nozzle check function cannot be used.	• NCU replacement is necessary. • Contact your local distributor, our sales office, or service center.
REPLACE NCU INK PAD	The NCU ink pad is full.	• It is necessary to replace the NCU ink pad. • Contact your local distributor, our sales office, or service center.
NCU ERROR Nozzle check OFF	Because an NCU-related error occurred during nozzle check, printing was stopped and the nozzle check function was turned OFF.	• Contact your local distributor, our sales office, or service center.

Ink Error

Ink error is displayed also in the local guidance. (☞ P.3-27)

Message	Cause	Solution
WRONG INK IC	The ink IC chip of the ink cartridge cannot be read normally.	<ul style="list-style-type: none"> Remove the cartridge generating the warning once and install it again. If the same warning message still appears, contact your local distributor, our sales office, or service center.
INK TYPE	The ink of the ink cartridge is different in type from the ink currently supplied.	<ul style="list-style-type: none"> Check the ink type of the cartridge generating the warning.
INK COLOR	The ink of the ink cartridge is different in color from the ink currently supplied.	<ul style="list-style-type: none"> Check the ink color of the cartridge generating the warning.
WRONG CARTRIDGE	An error occurred in the ink IC chip information of the ink cartridge.	<ul style="list-style-type: none"> Check the cartridge generating the warning. Make sure there is no nozzle clogging.
NO CARTRIDGE	An ink cartridge has not been installed in the slot.	<ul style="list-style-type: none"> Install an appropriate cartridge in the slot generating the warning.
INK END	The ink of the ink cartridge has been completely used up.	<ul style="list-style-type: none"> Replace the cartridge generating the warning with a new one.
INK NEAR END	There is only a little bit of ink left in the ink cartridge.	<ul style="list-style-type: none"> The ink will soon be used up. Be careful.
Expiration	The ink has expired.	<ul style="list-style-type: none"> Replace with new ink or use up as soon as possible. It is possible to print.
Expiration:1MONTH	One month has passed since the ink expired.	<ul style="list-style-type: none"> Replace with new ink or use up as soon as possible. It is possible to print.
Expiration:2MONTH	Two months have passed since the ink expired.	<ul style="list-style-type: none"> Replace with new ink. Cannot print.
ERROR 63c INK REMAIN ZERO	The ink remaining has become 0. (Only when ink end / 4 color ink set)	<ul style="list-style-type: none"> Replace the cartridge with a new one.
INK LVL LOW	When using a 600ml cartridge, the remaining ink has dropped to less than 60ml.	<ul style="list-style-type: none"> Remove and weigh the 600ml cartridge, then set it again. (☞ P.3-15 "When [Ink Level low] is displayed")
INK LVL END	When using a 600ml cartridge, the remaining ink has dropped to less than 25ml.	

Error messages

When an error message is displayed, eliminate the error according to the chart below.
If displaying again, contact your local distributor, our sales office, or service center.

Message	Cause	Solution
ERROR 122 CHECK:SDRAM	SDRAM is defective.	<ul style="list-style-type: none"> • Turn off the power to the machine and turn it on after a while. • If displaying again, contact your local distributor, our sales office, or service center.
ERROR 128 HDC FIFO OVER	Head control circuit board is defective.	
ERROR 128 HDC FIFO UNDER		
ERROR 129 BATTERY EXCHANGE	The battery life end of the internal clock is detected.	<ul style="list-style-type: none"> • Contact your local distributor, our sales office, or service center.
ERROR 130 HD DATA SEQ	Head data transferring sequence error occurred.	<ul style="list-style-type: none"> • Turn off the power to the machine and turn it on after a while. • If displaying again, contact your local distributor, our sales office, or service center.
ERROR 146 E-LOG SEQ	Sequential number abnormality of the event log occurred.	
ERROR 151 Main PCB V1R2	An error occurred in the main PCB .	
ERROR 152 Main PCB V2R5		
ERROR 153 Main PCB V3R3		
ERROR 154 Main PCB V05		
ERROR 157 Main PCB VTT		
ERROR 16e Main PCB V3R3B		
ERROR 15f HEAD DRIVE HOT	COM driver becomes the high temperature.	
ERROR 171 NEW HEAD CONNECT	New Print Head was recognized.	
ERROR 186 HDC OVERFLOW	An error is detected on the waveform printed on.	
ERROR 186 HDC UNDERFLOW		
ERROR 187 HDC SLEW RATE		
ERROR 188 HDC MEMORY		
ERROR 18a Main PCB V_CORE		

Message	Cause	Solution
ERROR 18c Main PCB V12	An error occurred in the main PCB .	<ul style="list-style-type: none"> • Turn off the power to the machine and turn it on after a while. • If displaying again, contact your local distributor, our sales office, or service center.
ERROR 190 Main PCB V42-1		
ERROR 192 COMIO PCB V1R2	An error occurred in the COM16/32IO PCB .	
ERROR 193 COMIO PCB V2R5		
ERROR 194 COMIO PCB V3R3		
ERROR 195 COMIO PCB V24		
ERROR 1a0 SLDR2H PCB V1R2	An error occurred in the SLIDER2H PCB .	
ERROR 1a6 SLDR2H PCB V2R5		
ERROR 1a7 SLDR2H PCB V3R3		
ERROR 1a8 SLDR2H PCB V5		
ERROR 1a9 SLDR2H PCB V42		
ERROR 201 COMMAND ERROR	The machine received some data other than print data. Or, an error occurred in the transmitted print data.	<ul style="list-style-type: none"> • Securely connect the interface cable in position. • Use an interface cable conforming to the specifications.
ERROR 202 PARAMETER ERROR	An error occurred in the transmitted print data.	
ERROR 304 USB INIT ERR	An error occurred in the communication of USB.	<ul style="list-style-type: none"> • Turn off the main power to the machine and turn it on after a while. • If displaying again, contact your local distributor, our sales office, or service center.
ERROR 305 USB TIME OUT		
ERROR 401 MOTOR X	An excessive load was applied to the X motor.	
ERROR 402 MOTOR Y	An excessive load was applied to the Y motor.	
ERROR 403 X CURRENT	An error due to an excessive current of the X motor was detected.	
ERROR 404 Y CURRENT	An error due to an excessive current of the Y motor was detected.	
ERROR 44f Take-UP Roll Sns Err	Roller sensor abnormality • The roller sensor cannot be correctly read.	<ul style="list-style-type: none"> • Confirm that the winding unit of machine setting and tension bar setting are ON. • Check the set state of the media. • Confirm that the winding unit operates using the manual SW.

Message	Cause	Solution
ERROR 45a P-HEAD TAKE OFF Err	Could not separate the print head.	<ul style="list-style-type: none"> • Turn off the main power to the machine and turn it on after a while. If displaying again, contact your local distributor, our sales office, or service center.
ERROR 45b P-HEAD CONNECT Err	Could not connect to the print head.	
ERROR 45c C-HEAD TAKE OFF Err	Could not separate the cutter head.	
ERROR 45d C-HEAD CONNECT Err	Could not connect to the cutter head.	
ERROR 45e CHECK PR/GR POSITION	The pinch roller position is not appropriate.	<ul style="list-style-type: none"> • Place the pinch roller above the grid roller. If displaying again, contact your local distributor, our sales office, or service center.
ERROR 505 MEDIA JAM	The media jam occurs.	<ul style="list-style-type: none"> • Remove the media and reset it.
ERROR 509 HDC POSCNT	An error occurred in the control position.	<ul style="list-style-type: none"> • Turn off the main power to the machine and turn it on after a while. If displaying again, contact your local distributor, our sales office, or service center.
ERROR 50a Y ORIGIN	Y-origin could not be detected.	
ERROR 50f L-SCALE BLACK	Abnormal linear scale.	
ERROR 516 MEDIA SET POSITION R	The media is set outside the proper area.	<ul style="list-style-type: none"> • Check the media set position. (☞ P.2-11)
ERROR 521 CHECK JOINT SENSOR	Does not detect the shade plate at the cut head connection.	<ul style="list-style-type: none"> • Turn off the main power to the machine and turn it on after a while. If displaying again, contact your local distributor, our sales office, or service center.
ERROR 522 CUT HOME POSIOTION	Does not detect the light shield plate at the standby position of the cut head.	
ERROR 523 CHECK PR SENSOR	Does not detect the shade plate at the pinch roller position.	
ERROR 528 PUMP MOTOR SENSOR	Pump sensor detection error	
ERROR 529 LEnc.Count HPC[]	Abnormal linear scale.	
ERROR 52a LEnc.Count HDC[]		
ERROR 52c MEDIA WIDTH SENSOR	The media width could not be correctly read.	<ul style="list-style-type: none"> • Check the media set position. (☞ P.2-4) • Clean the media sensor. (☞ P.5-3) • Turn the main power off once and turn it back on after some time.
ERROR 602 CARTRIDGE END	Ink end (cannot be used, can only be used when cleaning with the 4-color ink set)	<ul style="list-style-type: none"> • Replace with new ink.
ERROR 608 WRONG INK IC	The ink IC chip for ink cartridge cannot be correctly read.	<ul style="list-style-type: none"> • Make sure that the cartridge is correctly inserted. • Reinsert the cartridge. • Turn off the main power to the machine and turn it on after a while. If displaying again, contact your local distributor, our sales office, or service center.

Message	Cause	Solution
ERROR 612 INK LVL LOW	When using a 600ml cartridge, the remaining ink has dropped to less than 60ml.	<ul style="list-style-type: none"> Remove and weigh the 600ml cartridge, then set it again. (☞ P.3-15 “When [Ink Level low] is displayed”)
ERROR 613 INK LVL END	When using a 600ml cartridge, the remaining ink has dropped to less than 25ml.	
ERROR 614 Preservation Failure	Writing in IC failed in the 600ml cartridge use and the weight input.	<ul style="list-style-type: none"> Make sure that the cartridge is correctly inserted. Reinsert the cartridge. Turn the main power OFF, wait a while, and then turn it ON again. If the same error message appears, contact your local distributor, our sales office, or service center.
ERROR 627 RE-INSERT CARTRIDGE	There is a slot in which the cartridge has not been inserted more than a certain time.	<ul style="list-style-type: none"> Set a cartridge.
ERROR 628 WRONG INK CARTRIDGE	A problem has occurred in the ink IC chip information for ink cartridge. The used count has exceeded the prescribed value.	<ul style="list-style-type: none"> For MBIS or BS ink use. Replace the ink IC chip (Make sure to replace the ink IC chip at the same time to replace the ink pack). Make sure there is no nozzle clogging (especially for the white ink).
ERROR 63c INK REMAIN ZERO	Remaining ink is 0 in the cartridge (ink end/ only when the 4-color ink set is used).	<ul style="list-style-type: none"> Replace with new ink.
ERROR 64C NCU ERROR	The nozzle check has been suspended due to some problem.	<ul style="list-style-type: none"> Turn the main power off once and turn it back on after some time. If the same error message appears, contact your local distributor, our sales office, or service center.
ERROR 650 NCU CONECT	The NCU unit is not connected.	
ERROR 651 REPLACE NCU	The NCU sensor sensitivity is too low to correctly judge nozzle missing. The nozzle check function cannot be used.	
ERROR 652 NCU NZK CHK (HW)	The NCU cannot correctly recognize the ink discharge, because there are frequent nozzle missing and ink droplet misalignment.	<ul style="list-style-type: none"> Check the state of the nozzles, and if there are frequent nozzle missing and ink droplet misalignment, conduct cleaning to restore.
ERROR 653 NCU NZK CHK (MARK)		
ERROR 654 NCU CENTER POS	Adjustment of the discharge position to the NCU has failed.	
ERROR 655 NCU FLUSH POS		
ERROR 656 NCU SN ADJST	Sensor sensitivity adjustment has failed.	<ul style="list-style-type: none"> Check the state of the nozzles, and if there are frequent nozzle missing and ink droplet misalignment, conduct cleaning to restore. If the same error message still appears after restoring the state of the nozzles, contact your local distributor, our sales office, or service center.
ERROR 657 REPLACE NCU INK PAD	The NCU ink pat is full.	<ul style="list-style-type: none"> Contact your local distributor, our sales office, or service center.
ERROR 658 NCU SENSOR LV LOW	The NCU sensor sensitivity is falling.	<ul style="list-style-type: none"> Replacement of the NCU is recommended. Contact your local distributor, our sales office, or service center.

Message	Cause	Solution
ERROR 702 THERMISTOR CONNECT	The thermistor connection of a heater is defective.	<ul style="list-style-type: none"> • Check the thermistor connection of the drying heater. • Turn off the main power to the machine and turn it on after a while. • If displaying again, contact your local distributor, our sales office, or service center.
ERROR 710 HEATER TEMP ERROR	The temperature abnormality of the heater has been detected. When this error occurred and if the temperature abnormality cannot be resolved, the power supply of the machine is forcibly turned off.	<ul style="list-style-type: none"> • Turn off the main power to the machine and turn it on after a while. • If displaying again, contact your local distributor, our sales office, or service center.
ERROR 901 INVALID OPERATION	Due to a certain error, the function cannot be performed.	<ul style="list-style-type: none"> • Return to the local screen, check the error status and take a countermeasure.
ERROR 902 DATA REMAIN	There remains received data that has not yet been printed.	<ul style="list-style-type: none"> • Execute the data clear function. (☞ P.2-30)
ERROR 90d NO HEAD SELECT	An error occurred in the mounted heads.	<ul style="list-style-type: none"> • Turn off the main power to the machine and turn it on after a while. • If displaying again, contact your local distributor, our sales office, or service center.
ERROR 90f PRINT AREA SHORT	The media width or the media length required for printing is not enough.	<ul style="list-style-type: none"> • Change the media to the one with enough width or length. • When the media width narrows because the origin moved, slide the origin to the right to widen the effective media width.
ERROR 04 PARAM ROM	An error occurred in the main PCB FROM.	<ul style="list-style-type: none"> • Turn off the main power to the machine and turn it on after a while. • If displaying again, contact your local distributor, our sales office, or service center.
ERROR C10 COMMAND	Received the code other than the command date.	<ul style="list-style-type: none"> • Check the USB cable connection. Use the USB cable that complies with the specifications. Use the MIMAKI driver that matches the device. • Turn off the printer, wait for a while, and turn on the printer again. If displaying again, contact your local distributor, our sales office, or service center.
ERROR C11 PARAMETER	Received the parameters outside the value range.	
ERROR C12 DEVICE	Received the invalid device control command.	
ERROR C31 NO DATA	You have performed "Copy", but the data is not stored in the reception buffer.	<ul style="list-style-type: none"> • Execute Copy function using the same data one more time.
ERROR C32 DATAtooBIG	The received data is too big to multiple sheet cutting.	<ul style="list-style-type: none"> • The received data is too big to cut it in pieces.
ERROR C33 SHEET SIZE	The feeding direction of the sheet is too short.	<ul style="list-style-type: none"> • Use a longer sheet.

Message	Cause	Solution
ERROR C36 MARKdetect	Could not detect the registration marks.	<p>Check whether the registration marks are placed appropriately. (☞ P.4-5)</p> <p>Make sure that the media is not curled.</p> <p>Make sure that the position to start detecting the registration marks is correct.</p> <p>Make sure that black registration marks are printed on a white base.</p> <p>Make sure that there are no printed images or smudges between registration marks and that there is no dust adhered.</p> <p>Make sure that the registration mark detection settings are correct.</p> <p>If the registration marks still cannot be detected, even after clearing the check items above, contact your local distributor, our sales office, or service center.</p> <p>If the area around registration marks are colored, set the "MARK FILL UP" of the registration mark detection settings to ON.</p>
ERROR C37 MARK ORG	The registration mark detection result shows that the origin position was detected outside the print range.	<ul style="list-style-type: none"> Place the registration marks within the sheet.
ERROR C38 MARK SCALE	Could not detect the registration marks	<p>Check whether the registration marks are placed appropriately. (☞ P.4-5)</p> <p>Make sure that the media is not curled.</p> <p>Make sure that the position to start detecting the registration marks is correct.</p> <p>Make sure that black registration marks are printed on a white base.</p> <p>Make sure that there are no printed images or smudges between registration marks and that there is no dust adhered.</p> <p>Make sure that the registration mark detection settings are correct.</p> <p>If the registration marks still cannot be detected, even after clearing the check items above, contact your local distributor, our sales office, or service center.</p> <p>If the area around registration marks are colored, set the "MARK FILL UP" of the registration mark detection settings to ON.</p>
ERROR C60 PenEncoder	Could not detect the pen height.	<ul style="list-style-type: none"> Turn off the printer, wait for a while, and turn on the printer again. If displaying again, contact your local distributor, our sales office, or service center.
ERROR C61 Pen Stroke	The pen height is not correct.	<ul style="list-style-type: none"> Make sure that the pen line rubber is not worn out extremely, or it has not come off or changed form. Make sure that there is nothing adhered to the pen line rubber. After putting the pen in the commercially available pen holder, check that it is installed at the correct position. If an error is still displayed even after clearing the check items above, contact your local distributor, our sales office, or service center.

SYSTEM HALT

Message	Solution
SYSTEM HALT (*) 000 : MESSAGE	<ul style="list-style-type: none">• Turn off the main power to the machine and turn it on after a while. If displaying again, check the number and contact your local distributor, our sales office, or service center. ("000" is the error No.)
SYSTEM HALT (*) 406 : WIPER ORG	<ul style="list-style-type: none">• Perform cleaning around the wiper.• Turn off the main power to the machine and turn it on after a while. If displaying again, check the number and contact your local distributor, our sales office, or service center.

Chapter 7

Appendix



This chapter

contains the lists of the specifications and functions of this machine.

Specifications	7-2
Printer Section Specifications	7-2
Cutter Section Specifications	7-2
Common Specifications	7-3
Ink specifications	7-4
Setting orders of ink cartridges	7-5
LICENSE Library	7-6
Sheet for inquiry	7-7

Specifications

Printer Section Specifications

Item		CJV150-75 BS INK MODEL	CJV150-107 BS INK MODEL	CJV150-130 BS INK MODEL	CJV150-160 BS INK MODEL
Print head	Method	Drop-on-demand piezoelectric print heads			
	Specification	1 head staggered			
Printing mode (scan x feed)		360×360dpi/ 540×360dpi/ 540×720dpi/ 720×1080dpi/ 720×1440dpi/ 1440×1440dpi			
Usable inks		BS ink :4 colors (Y,M,C,K)			
Ink supply		Supplying from ink cartridges through tubes.Ink cartridge replacement type : Supplying by Toggle switch over with 2 cartridges/color (4-colors ink set)			
Capacity of ink cartridge		M, C, Y, K : 600ml cartridge			
Usable media		label stock (paper-based) / PVC sheet (including laminated; thickness no more than 0.25 mm) / Reflective sheet (excluding high-luminance reflective sheet) / Heat transfer rubber sheet			
Margin	Leaf media	Left end and right end : 15 mm (0.6 in) (Default) Front :120 mm (4.7 in) Rear : 150 mm (6.0 in)			
	Roll media	Left end and right end : 15 mm (0.6 in) (Default) Front :120 mm (4.7 in) Rear : 150 mm (6.0 in)			
Head height adjustment		Select for manual 3-stage (2.0/2.5/3.0) + 1 mm (0.04 in) or + 2 mm (0.08 in) at installation. Base height can be raised.			
Waste ink tank		Bottle type (2,000 ml)			
Interface		USB 2.0 (Ethernet 10 BASE/ 100 BASE E-mail function)			
Command		MRL- IV			

Cutter Section Specifications

Item	Specifications	
Maximum speed ^{*1}	30cm/s (118.1in/s)	
Maximum acceleration	1G	
Cutting pressure	10 to 450g	
Usable tools	Eccentric cutter/ water-based ballpoint pen/ oil-based ballpoint pen/ Ballpoint pen for handwriting (sold on the market) ^{*2}	
Number of times the cutter responds to a medium	10 times/sec	
Usable media	Polyvinyl chloride sheet (Thickness of 0.25mm (0.01 in) or less with laminate ^{*3})/ fluo- rescent sheet ^{*4} / reflecting sheet ^{*4} (excluding high-intensity reflecting sheets)/ Label card (paper-based)/ Heat transfer rubber sheet	
Margin	Leaf media	Left and right: 15mm (0.6 in) (default value), Minimum : 5mm (0.2 in) Front :135 mm (5.3 in) Rear : 150 mm (5.9 in)
	Roll media	Left and right: 15mm (0.6 in) (default value), Minimum : 5mm (0.2 in) Front :135 mm (5.3 in) Rear : 150 mm (5.9 in)
Repetition accuracy ^{*5}	±0.2 mm (0.008 in) or the ±0.1% of the specified distance, whichever is larger.	
Reception buffer memory	256 MB	
Command	MGL-II c2	
Program step	25µm	

*1. The maximum speed may be limited, depending on the size of a used medium. In addition, the cutting section does not operate with both speed and acceleration being at the maximum.

*2. Use one with a diameter of 8 to 9 Φ whose clamped part has no protrusion or taper. In addition, because the position of the pen point changes, depending on the types of pens, no good image quality can be ensured.

*3. This conforms with our specified sheet.

*4. When a blade dedicated for fluorescent sheets (SPB-0007) or a blade dedicated for reflecting sheets (SPB-0006) is used.

*5. For repetition accuracy, see the lower part of this page.

Common Specifications

Item		CJV150-75 BS INK MODEL	CJV150-107 BS INK MODEL	CJV150-130 BS INK MODEL	CJV150-160 BS INK MODEL
Max. printing/ cutting width		800mm (31.5in)	1090mm (42.9in)	1361mm (53.6in)	1610mm (63.4in)
Roll Media size	Maximum	810mm (31.9in)	1100mm (43.3in)	1371mm (54.0in)	1620mm (63.8in)
	Minimum	210mm (8.3in)			
	Thickness	1.0mm (0.04in) or less			
	Roll outside diameter ^{*1}	Paper media : Φ 250mm (9.8in) or less Other media : Φ 210mm (8.3in) or less			
	Roll weight ^{*1, *2}	40kg (88.1lb) or less			
	Roll inside diameter	2 or 3 inches			
	Printing surface	Side facing outward			
	Roll end treatment	The roll end is gently fixed to the core with weak-adhesive tape or weak glue for easy removal.			
Leaf media size	Maximum	810mm (31.9in)	1100mm (43.3in)	1371mm (43.3in)	1620mm (63.8in)
	Minimum	210mm (8.3in)			
Distance accuracy	Absolute accuracy	Whichever the larger one of ± 0.3 mm (0.01in) or ± 0.3 % of the designated			
	Reproducibility	Whichever the larger one of ± 0.2 mm (0.008in) or ± 0.1 % of the designated			
Perpendicularity		± 0.5 mm (0.02in)/ 1000 mm (39.4in)			
Media skew		5 mm (0.2in) or less / 10 m (32.8ft)			
Cutting of media		Cutting of Y direction by the head cutter. Cutting accuracy (steps) : 0.5 mm (0.002in) or less.			
Media delivery		Take-up device supplied as a standard accessory (switching possible between face in and face out).			
Interface		USB 2.0 (Ethernet 10 BASE/ 100 BASE E-mail function)			
Noise	during standby	Less than 58 dB (A) (FAST-A, Front & Rear & Left & Right 1 m)			
	during continuous printing	Less than 65 dB (A)			
	during discontinuous printing	Less than 70 dB (A)			
Safety Standard		VCCI-Class A, FCC-Class A, UL 60950, CE Marking (EMC, Low Voltage Directive, Machinery Directive, RoHS Directive), CB Report, IEC 62368-1 ETL, EAC mark, RoHS			
Power		Single-phase (AC100 - 120V 1440W or less / 220 - 240V 1920W or less) $\pm 10\%$ 50/60Hz ± 1 Hz			
Power consumption		1440W (AC 100 - 120V) or less			
Recommended Environment	Available temp.	20 °C (68 °F) to 30 °C (86 °C)			
	Humidity	35 to 65% Rh (No condensation)			
	Guaranteed temp.	20 °C (68 °F) to 25 °C (77 °F)			
	Temperature change	± 10 °C (50 °F) / h or less			
	Dust	Equivalent to normal office level			
	Highest operation height	2000 m (6561.7 ft)			
Weight		126 kg (277.8 lb)	142 kg (313.1 lb)	157 kg (346.1 lb)	168 kg (370.4 lb)
Outside dimensions	Width	1965mm (77.4in)	2255mm (88.8in)	2525mm (99.4in)	2775mm (109.2in)
	Depth	700mm (27.6in)			
	Height	1392 mm (54.8 in)			

*1. It is outside diameter and weight after take-up media.

*2. Without deflection of the roll when it is retained at both ends.

Ink specifications

Item		BS3/ BS4 ink
Supply		Dedicated sublimation dye ink cartridge
Color		Black ink cartridge Cyan ink cartridge Magenta ink cartridge Yellow ink cartridge
Ink capacity		600ml per cartridge
Shelf life		The period is printed on the ink cartridge. Within three months after opening the package even in the available period.
Storage temperature	Storage	10 to 35°C (50 to 95°F) (Average daily temperature) Be sure to keep a vessel in the airtight condition. Be sure to keep a vessel in a dry, well-ventilated, cool and dark location.
	Transportation	0 to 40°C (32 to 104°F) Avoid the condition lower than 0 °C (32 °F) and higher than 40 °C (104 °C).

Important!

- Do not disassemble ink cartridges and do not refill them with ink.
- Ink could freeze if kept in a cold place for an extended period.
- When aqueous ink is used, if the ink freezes, the quality is changed and the ink becomes unusable.
Store the ink in an environment that will not freeze the ink.

Setting orders of ink cartridges



- Set the ink cartridge according to the cartridge label under the ink station.

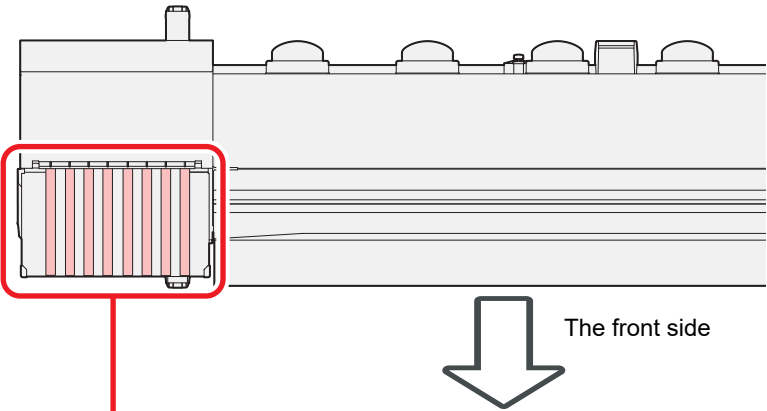

4-colors model	M	M	C	C	Y	Y	K	K
-----------------------	---	---	---	---	---	---	---	---

LICENSE Library

Mimaki printer Firmware

Copyright ©2020 MIMAKI ENGINEERING CO.,LTD. All rights reserved.

This product contains open source software listed in the tables below.

Component	License
StarterWare for ARM® based TI Sitara Processors	BSD-TI

The following license terms and conditions shall apply to the open source software listed in the table above:

BSD-TI

Copyright (C) 2010 Texas Instruments Incorporated - <http://www.ti.com/>

Redistribution and use in source and binary forms, with or without modification, are permitted provided that the following conditions are met:

1. Redistributions of source code must retain the above copyright notice, this list of conditions and the following disclaimer.
2. Redistributions in binary form must reproduce the above copyright notice, this list of conditions and the following disclaimer in the documentation and/or other materials provided with the distribution.
3. Neither the name of Texas Instruments Incorporated nor the names of its contributors may be used to endorse or promote products derived from this software without specific prior written permission.

THIS SOFTWARE IS PROVIDED BY THE COPYRIGHT HOLDERS AND CONTRIBUTORS "AS IS" AND ANY EXPRESS OR IMPLIED WARRANTIES, INCLUDING, BUT NOT LIMITED TO, THE IMPLIED WARRANTIES OF MERCHANTABILITY AND FITNESS FOR A PARTICULAR PURPOSE ARE DISCLAIMED. IN NO EVENT SHALL THE COPYRIGHT OWNER OR CONTRIBUTORS BE LIABLE FOR ANY DIRECT, INDIRECT, INCIDENTAL, SPECIAL, EXEMPLARY, OR CONSEQUENTIAL DAMAGES (INCLUDING, BUT NOT LIMITED TO, PROCUREMENT OF SUBSTITUTE GOODS OR SERVICES; LOSS OF USE, DATA, OR PROFITS; OR BUSINESS INTERRUPTION) HOWEVER CAUSED AND ON ANY THEORY OF LIABILITY, WHETHER IN CONTRACT, STRICT LIABILITY, OR TORT (INCLUDING NEGLIGENCE OR OTHERWISE) ARISING IN ANY WAY OUT OF THE USE OF THIS SOFTWARE, EVEN IF ADVISED OF THE POSSIBILITY OF SUCH DAMAGE.

Sheet for inquiry

Use this sheet for troubles and abnormal functions of the machine.
Fill in the following necessary items, and fax the sheet to our sales office.

Company name	
Person in charge	
Telephone number	
machine model	
Operating OS	
Machine information *1	
Error message	
Contents of inquiry	

*1. Refer to "Confirming Machine information" of "Convenient using" then fill in necessary information. (☞ P.3-27)

CJV150 series BS INK MODEL Operation Manual

November, 2022

MIMAKI ENGINEERING CO.,LTD.

2182-3 Shigeno-otsu, Tomi-shi, Nagano 389-0512 JAPAN

D202773-18-01112022

